

# Antennas for High-Precision GNSS Applications

**Roshni Prasad**

Associate Engineer – RF & Connectivity  
Abracon, LLC



**Abstract:** The increasing interest in high-precision GNSS/GPS services has led to the development of novel antenna solutions to service various end-customer applications in markets such as agriculture, recreation, surveying & mapping, and timing. Multi-band receivers and antennas are required to derive a higher-precision rate on positioning. However, using dedicated antennas for widely separated multi-band support may introduce several challenges in the design, including increased occupancy in board space and coupling. This application note reviews how these challenges are addressed by employing a single multi-band antenna. The discussion primarily focuses on Abracon’s internal and external antenna solutions that can cover multiple GPS and/or GNSS bands as a single entity for precision positioning applications.

## [Index](#)

### **Introduction to GNSS**

### **Antennas for Multi-band GNSS Receivers**

### **Types of Antennas for Multi-Band GNSS Receivers**

### **Integrating Antennas in GNSS Applications**

### **Key Factors in Determining Antenna Performance**

### **Advantages of Using Multi-band GNSS**

### **Conclusion**

### **References**

## 1. Introduction to GNSS

### What is GNSS? Why is GNSS needed? What are the available constellations?

Global Navigation Satellite System (GNSS) is a satellite-based navigation and positioning system that offers a prediction of coordinates in space, with respect to velocity and time, to assist in the navigation and positioning of receiver systems. The service is supported by various global constellations, including GPS (U.S.), GLONASS (Russia), Galileo (Europe), and regional constellations such as BeiDou (China), QZSS (Japan) and IRNSS (India).

### How is the positioning accuracy? What are some applications?

Global Positioning System (GPS) satellite communication is the most popular of all the GNSS services. In the commercial space, it has traditionally operated in the L1 band (1575 MHz) with a positioning accuracy of a few meters. The addition of L2 (1227 MHz) into the commercial space helped improve overall system robustness and facilitated greater achievements in positioning accuracy. The newly introduced higher-power L5 band introduces tri-band (multi-band) GPS operation and offers extended capabilities to positioning accuracy. L2 and L5, in addition to GNSS/GPS L1, are already the preferred choices for commercial air, land, and marine navigation-based services applications, including unmanned aerial vehicles (UAVs), autonomous vehicles (V2X), machine-to-machine (M2M) communication, precision farming, timing, surveying and mapping, construction, geofencing and remote monitoring to name a few [1].

### So, to what frequencies do the GPS L1, L2 and L5 bands correspond?

#### L1 Band

A traditional commercial GNSS/GPS receiver only employs the L1 frequency band. Most of today's positioning systems operate in the L1 band. Coarse/Acquisition Code (C/A) and Precision code (P-code) are the two ranging codes, and only C/A is available for commercial applications. The L1 C/A band of GPS operates at  $1574.42 \pm 1.023$  MHz and offers a few meters of positioning accuracy.

#### L2 Band

L2 operates in the 1227.6 MHz band and was released for public use as L2C in recent years. It is more sophisticated than L1 C/A. Even though the L2C signal strength is weaker than the L1 C/A code by 2.3 dB, a receiver can still track the signals with a data recovery of 27 dB and a carrier tracking of 0.7 dB greater than L1 C/A. In addition, L2C uses FEC (Forward Error Correction) and Civil Long (CL) code to provide greater precision in terms of positioning, especially in obstructed areas like wooded and urban environments. Thus, L2C is more desirable for ranging and surveying applications [2].

#### L5 Band

L5 operates in the 1126 MHz band. The signal carries twice as much power as L1 and currently supports only civilian applications. In addition, while L2 occupies a band that is shared with ground-based radars, the L5 band does not share the frequency with anything but the E5A signals of Galileo. This makes it a more suitable choice for urban applications to discriminate against undesired multipath and interference signals [3].

**How do we receive GNSS/GPS signals?**

A GNSS/GPS radio frequency (RF) module and an antenna are primarily required to form the receiver. Additionally, the receiver must have simultaneous visibility to a minimum of four [4] satellites in order to successfully retrieve the three-dimensional, real-time position of the target. Using GPS L1 in combination with GPS L2/L5/GLONASS/BeiDou/ Galileo may aid toward faster locking and greater positioning accuracy. Further, an object’s positioning is primarily affected by the degradation of signal due to environmental factors, atmospheric conditions and receiver design.

This paper will discuss the crucial role that antennas play in establishing communication as a part of the receiver, and a specific focus will be given to Abracon’s multi-band high performance internal stacked patch antennas and external antennas with excellent in-band characteristics, which can be integrated with multi-band GPS and/or GNSS receivers.

**2. Antennas for Multi-band GNSS Receivers**

A receiver’s thermal noise floor level and its ability to suppress multipath signals dictate the system accuracy. Thermal noise is mainly generated by active components in the printed circuit board (PCB), by external channel interference, or by an antenna [5]. A multipath propagation environment introduces losses and phase shifts on the satellite-transmitted signal. With an ever-increasing amount of satellite-based services, a well-designed receiver antenna can help overcome some of these challenges.

The miniaturization of GPS receiver systems in recent years has reduced the available space reserved for antennas in the PCB. Additionally, embedding separate antennas dedicated for the L1, L2 and L5 bands may introduce mutual coupling, which may degrade the overall system performance. Some applications may require the antenna to be mounted external to the PCB in an indoor or outdoor environment. Both these scenarios of having the antenna mounted external to the housing may pose a variety of challenges in terms of exposure to extreme temperatures, high humidity, fluid susceptibility, corrosive chemicals, over pressure, fire/flammability, vibration or lightning/shock. A careful evaluation of the variables affecting the antenna and its performance should be carried out.

Additionally, based on the chipset/module, a receiver may require single or multiple antenna connections, as shown in Figures (1) and (2), respectively [6]. In the commercial space, a single antenna has been commonly employed for GNSS/GPS receivers. However, in many upcoming applications, including UAVs (e.g., drones), GNSS receivers need to use two or more antennas for precision positioning. When multiple antennas are employed, a maximum separation shall be ensured between them.

Most wireless systems, including portable PDAs and tracking devices, have passive antennas hidden within the electronics housing, but there are also cases in which having an active antenna may supply added value, particularly when the application is employed in a forest or in an urban area.



*Figure 1: GNSS/GPS single channel receiver (i) single antenna with LNA + pre-filter (ii) single passive antenna*

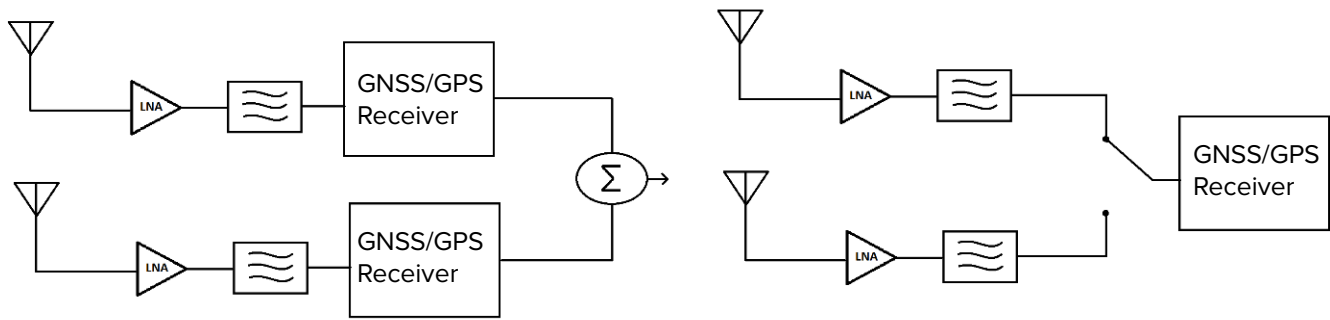

Figure 2 : GNSS/GPS (i) multi-channel receiver with multiple antennas (ii) switched channel receiver with multiple antennas

### Active Antennas

For critical applications, an active antenna may prove to be more useful. While the filter circuit in the active antenna helps eliminate undesired signal interference and delivers the system with only the signals that fall into the bandwidth of interest, the amplification circuit (LNA) boosts the desired signal strength without degrading the signal-to-noise ratio (SNR). Also, when the distance between the antenna and the receiver module is large, having an LNA helps retain signal strength by compensating for the cable loss. Additionally, when an RF module is chosen without a built-in LNA, an active antenna can help boost the received signal strength.

When an active antenna is chosen, one must ensure that the filters are selected with low loss, suitable bandwidth and phase linearity to minimize the signal constellation errors. Also, the LNA must be chosen with nominal gain, minimal noise figure and unconditional stability [7].

### Passive Antennas

A passive antenna is comprised only of a radiating element and the feed. If a passive antenna is used, then there is no need for an external power source. These antennas are best suitable for applications that work in low-power environments. It is best to retain the transmission feed line connected to the antenna that is as short as possible to minimize losses.



## 3. Types of Antennas for Multi-Band GNSS Receivers

An antenna plays a key role in receiving the satellite signals and helping facilitate successful signal processing in a GNSS receiver. Different types of internal and external antennas are proposed for different application environments.

### Internal Antennas

Patch antennas are the preferred solution for most commercial GNSS applications because of their low profile, compact size, ease of manufacturing and low cost. In addition, the design facilitates both directional and omnidirectional pattern characteristics, which improves signal reception and optimal receiving range. Additionally, the design commonly employs circular polarization, which introduces design flexibility in several ways. But, by nature, this type can only accommodate a narrow bandwidth. In order to serve multiple frequency bands, Abracon has introduced the following active and passive stacked patch antennas.

Table 1 : Abracon Internal GNSS Antenna Solutions

Antenna Image	Band Support	Abracon Part Number	Size (mm)	LNA Characteristics	Datasheet
<b>Internal Antenna - Active Stacked Patch</b>					
	L5 + L2 + L1	APARC2511X-SGL2L5	25.0 x 25.0 x 12.4	G : 30 dB, NF <sub>max</sub> = 1.3 dB	<a href="#">View Datasheet</a>
	L5 + L1/ GNSS	APARC2511X-SG3L5	25.0 x 25.0 x 13.0	G : 28 dB, NF <sub>max</sub> = 1.0 dB	<a href="#">View Datasheet</a>
<b>Internal Antenna - Passive Stacked Patch</b>					
	L5 + L1	APAKM2507S-SGL5	25.0 x 25.0 x 7.5	N/A	<a href="#">View Datasheet</a>
	L5 + L2 + L1	APARM2508S-SGL2L5	25.0 x 25.0 x 8.0	N/A	<a href="#">View Datasheet</a>
	L5 + L1/ GNSS	APARM2508S-SG3L5	25.1 x 25.1 x 8.0	N/A	<a href="#">View Datasheet</a>
	L2 + L1	APAKM3513-SGL2	35.6 x 35.6 x 13.5	N/A	<a href="#">View Datasheet</a>



The solutions are designed for use in narrow and wide band GNSS receivers. While the cost-effective APAKM2507S-SGL5 solution operates with a very narrow band characteristics of about 2.046 MHz just to receive the C/A code, the APARM2508S-SG3L5 has a wider operating bandwidth range of up to 28 MHz, especially in the upper GNSS band.

The size of the antenna directly dictates the sensitivity and operating bandwidth. Abracon’s stacked patch antenna dimensions vary from 25.0 x 25.0 mm up to 35.6 x 35.6 mm to address different application requirements. To have improved performance, an antenna of larger dimension shall be employed.

### External Antennas

External antennas are available in puck, dome or whip types and are tailored for various end-application environments. Abracon’s below mentioned solutions for multi-band receivers include an internal passive stacked patch or an internal quadrifilar helix operating in axial mode with an active LNA and internal filter. Abracon’s external antennas are equipped with low loss, high-performance low noise amplifiers (LNAs) to boost the signal strength and, therefore, the overall system performance. Since these external antennas do not share the board space in most applications, a larger form factor may be acceptable. A larger profile for the antenna allows for better signal-to-noise ratio (SNR) at the receiver.

Table 2 : Abracon External GNSS Antenna Solutions

Antenna Image	Band Support	Abracon Part Number	Size (mm)	LNA Characteristics	Datasheet
	Entire GNSS	AEAGMK148060-S1575	D148.0 x 60.0	G : 38 dB, NF <sub>max</sub> : 1.5 dB	<a href="#">View Datasheet</a>
	GPS - L5 + L2 + L1/ GNSS	AEAC-BA050018-SG4L2L5	50.0 x 50.0 x 18.0	G : 28 dB, NF <sub>max</sub> : 1.0 dB	<a href="#">View Datasheet</a>
	L5+ L1/ GNSS	AEACAC055027-SG4L2	55 x D27	G : 33 dB, NF <sub>max</sub> : 1.5 dB	

## 4. Integrating Antennas in GNSS Applications

Choosing an antenna’s location and position for your GNSS application dictates the antenna’s ability to see as many satellites in the sky as possible, to maintain a stable phase center and to discriminate the multipath signals. Additionally, for best performance, the boresight of the antenna should be pointed toward the sky.

In general, when mounting two or more GNSS antennas for diversity in an application, the antennas must be properly isolated to avoid coupling. Ideally, a 20 to 30 dB isolation [8] is desired, and a minimum of 10 dB shall be maintained for antennas that share a common ground plane to maintain the performance. The correlation among internal antennas can be minimized by placing two solutions of same polarization orthogonally.

Mounting should be adjusted based on the received signal strengths. GNSS signals are susceptible to interference from cellular signals because of the weaker signal strength. So, the mounting of GNSS antennas must be carefully evaluated, especially if other cellular antennas are present in the board.

### Internal Antennas

A patch antenna always needs to be mounted on the top layer of the PCB and must have an unobstructed visibility to the sky. If the orientation of the board is undeterminable, it is recommended to place the patch antenna in the middle of the PCB (Figure 3). An antenna with circular polarization can be chosen to introduce flexibility in terms of orientation. It should be ensured that there are no metal components within a 10 mm vicinity of the antenna.

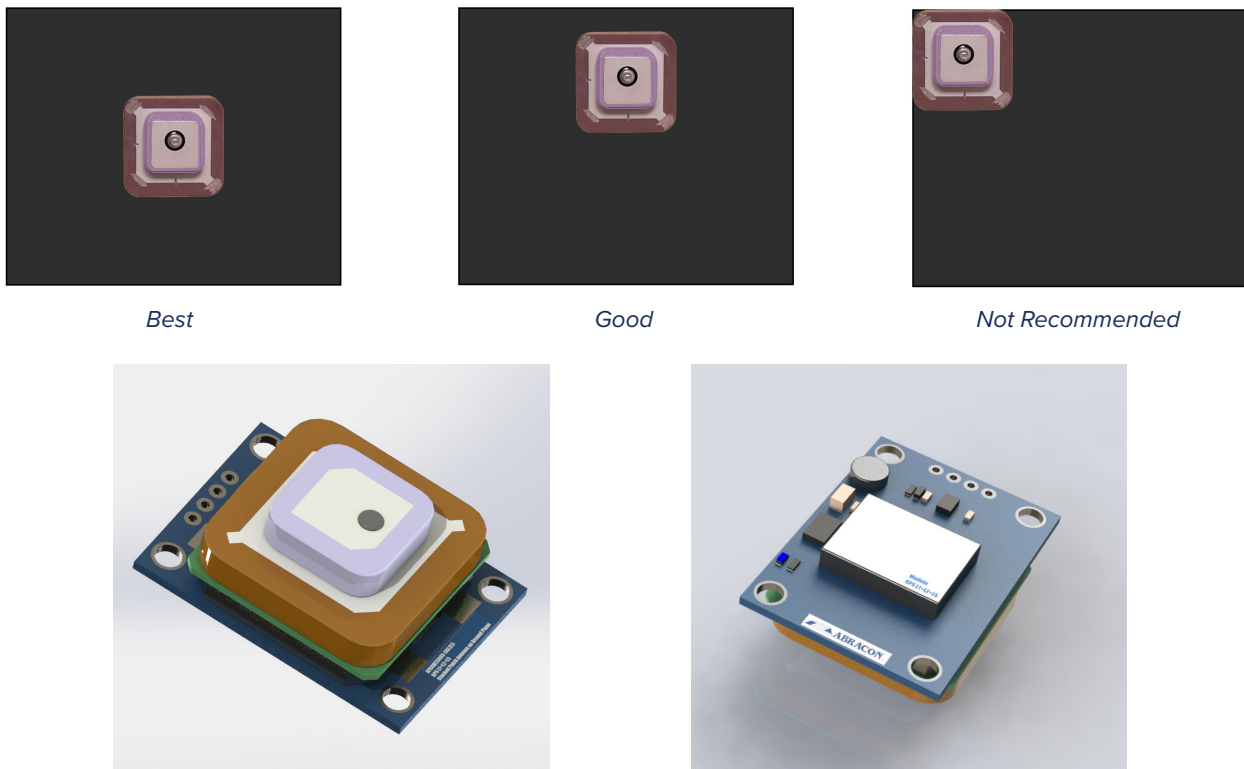

Figure 3: Placement of patch antenna  
 (An example of APARM2508S-SGL2L5 is shown here, but is applicable to all types of patch antenna.)

Abracon's internal passive stacked patch solutions (Table 1) can be mounted on the metal plane, which acts as ground using the through-hole pin and adhesive tape. The pin can be soldered to the feedline on the back side of the PCB. Upon request, the passive solutions can be tuned for a specific ground plane size and provided with a cable and connector for ease of use.

Abracon's internal active antennas are designed and tuned with a ground plane, cable and connector. They can be mounted directly on the PCB clearance space without the need for an additional ground plane or antenna impedance matching. The cable and connector are fully customizable to suit an application's design-specific requirements. Although, it is recommended that the cables are maintained at the shortest possible length to minimize losses.

## External Antennas

An external satellite-based antenna should be situated with an unobstructed view toward the sky. An antenna designed for outdoor applications must be appropriately grounded to ensure proper operation and to protect it against lightning strikes. Abracon offers a variety of external antennas with different mounting types, including connector, adhesive, magnet and screw options. These solutions can be customized with desired cable types, cable lengths and connector options. In addition, to protect the antenna from external factors, ingress protection and UV resistant coating are fully customizable options for outdoor Abracon antennas.

For instance, the mechanical stability allows the AEAGMK148060-S1575 antenna to be best suited for use in UAVs and other high-impact vibration environments. In addition, the IP67 rating protects it in dust and water environments. In addition, this antenna not only operates in the entire GNSS band but also, has excellent electrical characteristics. It has a low loss design at both the antenna feed (VSWR <2) and the LNA (NF <1.5 dB), which allows it to utilize the best of the antenna gain (4.5 dBi peak) and the LNA gain (38 dB at 3 V).

The ultra-low profile AEACAC055027-SG4L2 device is a loaded quadrifilar helix antenna (QHA) that supports multiple bands, including GPS L1/L2, GLONASS G1/G2, BeiDou/Compass B1/B2/B3 and Galileo E1/E5b. The design offers maximal right-hand circular polarization (RHCP) gain at all elevation angles above the mask angle and at all operating frequencies. For surveying and mapping applications, it is essential that the system filters out multipath signals and atmospheric delays. This is especially important when the antenna is employed in elevated or variable altitudes; a proportion of the GPS signal may enter the antenna from lower or backward angles. The AEACAC055027-SG4L2 and AEAGMK148060-S1575 antennas are designed to reject signals from lower elevated and backward angles. For easier mounting, an SMA (M) connector is included in the antenna design.

With puck-type antennas, magnetic and adhesive mounting options are available. The AEACBA050018-SG4L2L5 antenna is manufactured with an adhesive tape at the bottom, which can be pasted onto glass plastic and metal surfaces. This antenna can be fed using the cable and connector designed with it. Some of Abracon's puck solutions are ground plane independent. This property allows these antennas to find use in various applications.



*Figure 4: UAV (Eg : Drone) - An example of AEAGMK148060-S1575 is shown here. Either of the internal or external antennas discussed in this paper can be employed.*



*Figure 5: Surveying - The AEAGMK148060-S1575 antenna is illustrated here. However, the AEACAC055027-SG4L2 antenna can also be used.*

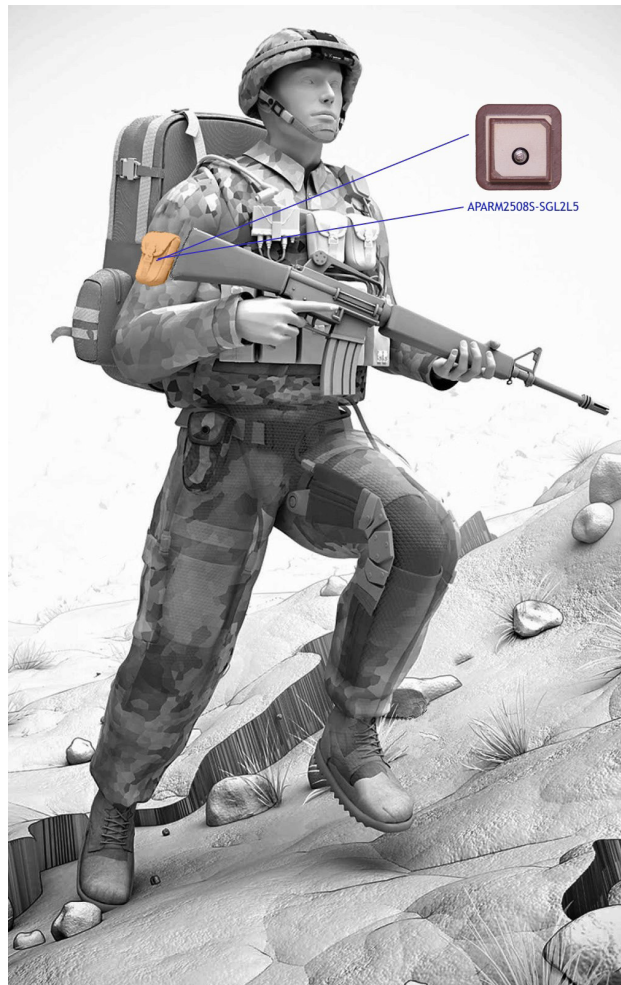

*Figure 6: Precision Target Tracking & Positioning - An example of the APARM2508S-SGL2L5 antenna is illustrated here. Any of the internal solutions discussed in this paper can be used.*

## 5. Key Factors in Determining Antenna Performance

There are some key parameters related to an antenna that can make or break the signal reception from the satellites. These include the operation frequency, gain, polarization, efficiency and overall loss. These parameters are briefly discussed in the following sections.

### Antenna Input Impedance

Input impedance dictates how much of the input power is delivered to the antenna within the resonant bandwidth. Hence, impedance matching at the antenna’s input-end is very important. An antenna’s impedance can be visualized using a Smith chart, a voltage standing wave ratio (VSWR) graph or a return loss (S11) graph by plugging the antenna to a calibrated vector network analyzer (VNA) port. The plot below shows the return loss characteristics as a function of frequency for several Abracon antennas discussed in this paper.

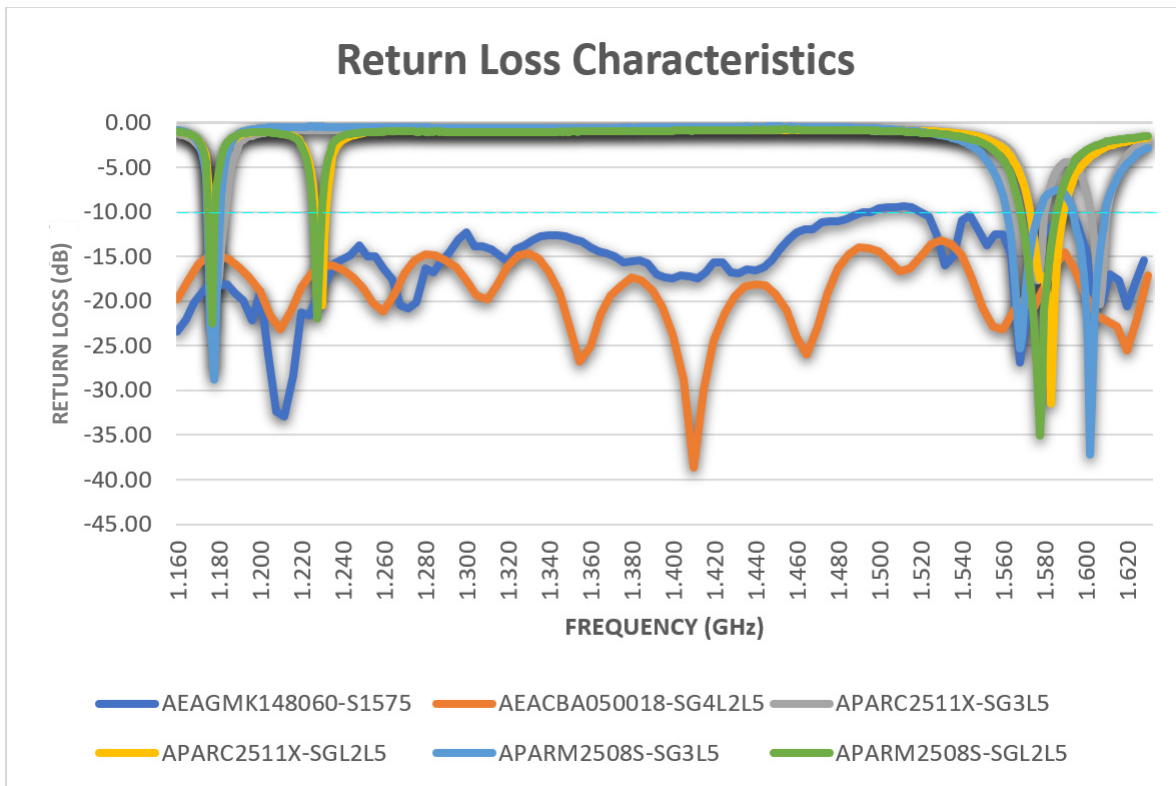

Figure 7: Return loss characteristics of all Abracon antennas discussed in this paper

Internal passive patch antennas should be mounted on the center of the ground plane at the end-application PCB and matched to 50 ohms impedance at the feed. Abracon offers an optimization service to tune the patch antenna into the desired operating band and to account for any frequency shifts that have occurred due to electrical characteristics of the board. A larger ground plane size is recommended for best performance.

Abracon’s internal active antennas are tuned to resonate at the desired frequency along with a ground plane, cable and connector. All Abracon external antennas are also tuned to 50 ohms and are terminated with a cable and connector or just a connector. This facilitates the ease of use when integrating these antennas in the end application without impacting the resonant bandwidth.

## Antenna Gain and Radiation Pattern

An antenna’s ability to receive signals from satellites is mainly determined by two factors: gain and beamwidth. Applications such as remote monitoring and surveying require exceedingly high gain antennas for better signal reception and consequently, for improved performance.

An antenna’s gain directly correlates with multipath rejection and must be carefully characterized to discriminate the lower elevation multipath signals from entering the receiver. Ideally, a GNSS antenna is expected to present a normalized gain toward all satellites of visibility while mitigating or rejecting the multipath signal interference from lower elevation angles and back angles.

Additionally, to avoid the multipath signals from lower elevation angles and to reduce the geometric dilution of precision (GDOP), a mask angle is carefully set between 5° and 14° for GPS + GLONASS and between 11° and 23° for GPS + GLONASS + Galileo [9][10].

All Abracon antennas that are inclusive of ground plane present a broad radiation pattern over the upper hemisphere, which is ideal for GNSS applications. For instance, the elevation gain roll-off of the AEAGMK148060-S1575 antenna is presented below with a peak gain at its zenith (Figure 8). Ideally, antenna gain is equally distributed along all 360 degrees of the azimuthal angles surrounding the antenna above the mask angle.

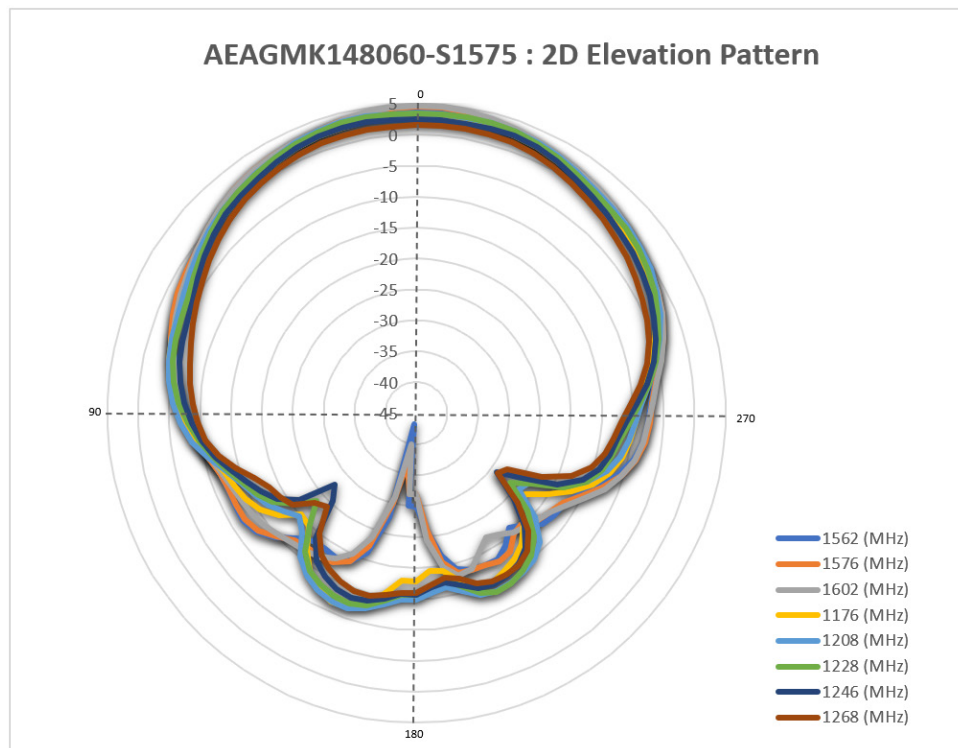

Figure 8: Radiation pattern (AEAGMK148060-S1575)

Considering the QHA – helix antenna, as we see in the below XZ pattern (Figure 9), there is a uniform gain along the elevation angles above the mask angle. We also observe about 6 to 10 dB difference in the gain between upper and lower elevation angles with respect to the mask angle. The front-to-back ratio of the antenna is about 15 dB and can reject any reflected signal entering the system from the bottom (Figure 9 and 10).

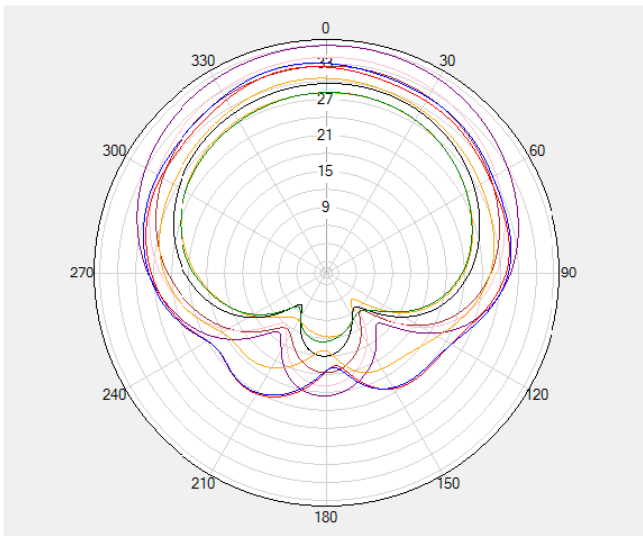

Figure 9: XZ Pattern (AEACAC055027-SG4L2)

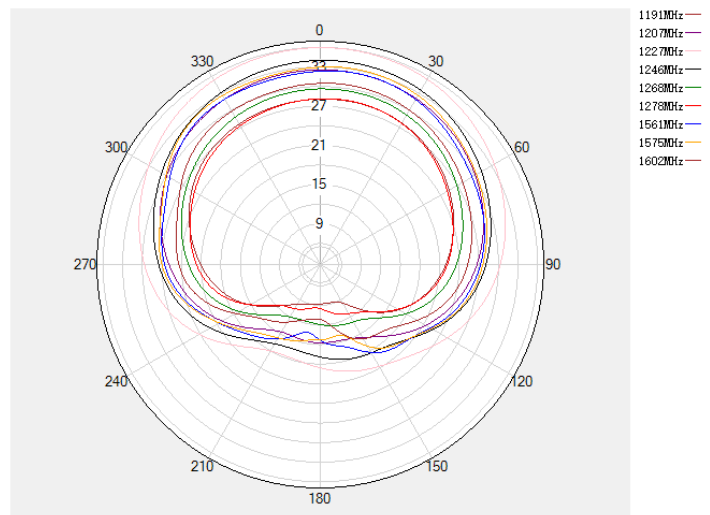

Figure 10: YZ Pattern (AEACAC055027-SG4L2)

**Antenna Polarization**

The antenna at the satellite station in orbit is designed to transmit right-hand circularly polarized (RHCP) waves with a slight offset into elliptical polarization. An RHCP antenna at the receiver is highly recommended for following major reasons:

- i. For maximum signal reception, both the transmitter and the receiver antennas must support the same type of polarization.
- ii. Multipath signals are left-hand circularly polarized (LHCP) based on the assumption that the signal falling on a smooth reflecting surface is incident at an angle less than Brewster’s angle. Since RHCP and LHCP signals are orthogonal, a well-designed RHCP antenna (with good axial ratio) can discriminate the LHCP signals from entering the receiver system from lower elevation angles by almost 10 dB. When the signals are reflected off a rough surface, the polarization becomes unpredictable; hence, an RHCP antenna can attenuate only half the signal’s power [11].

A circularly polarized (CP) antenna’s polarization efficiency can be determined by studying its axial ratio. In general, for an antenna with good polarization efficiency, the axial ratio is not to exceed 3 dB. For instance, the AEACAC055027-SG4L2 has a maximum axial ratio of 3 dB, while it is less than 2 dB for the AEAGMK148060-S1575.

Although antennas with RHCP is preferred, some low cost and ultra-compact commercial applications use a linearly polarized antenna. The polarization mismatch introduces a 3 dB loss in an ideal case. In urban environments, where there is a predominant multipath, linearly polarized antennas are found to perform as equally as RHCP antennas [12].

**Antenna Efficiency**

For antennas that transmit, efficiency translates as radiated efficiency. For GNSS, since there are no radiated emissions, the antenna efficiency translates as the proportion of the captured power being

delivered as useful electrical signal into the RF system. The plot below highlights the efficiency plot for several Abracon antennas discussed in this paper (Figure 11). As depicted in the figure below, these antennas exhibit a good standing efficiency in all their working bands.

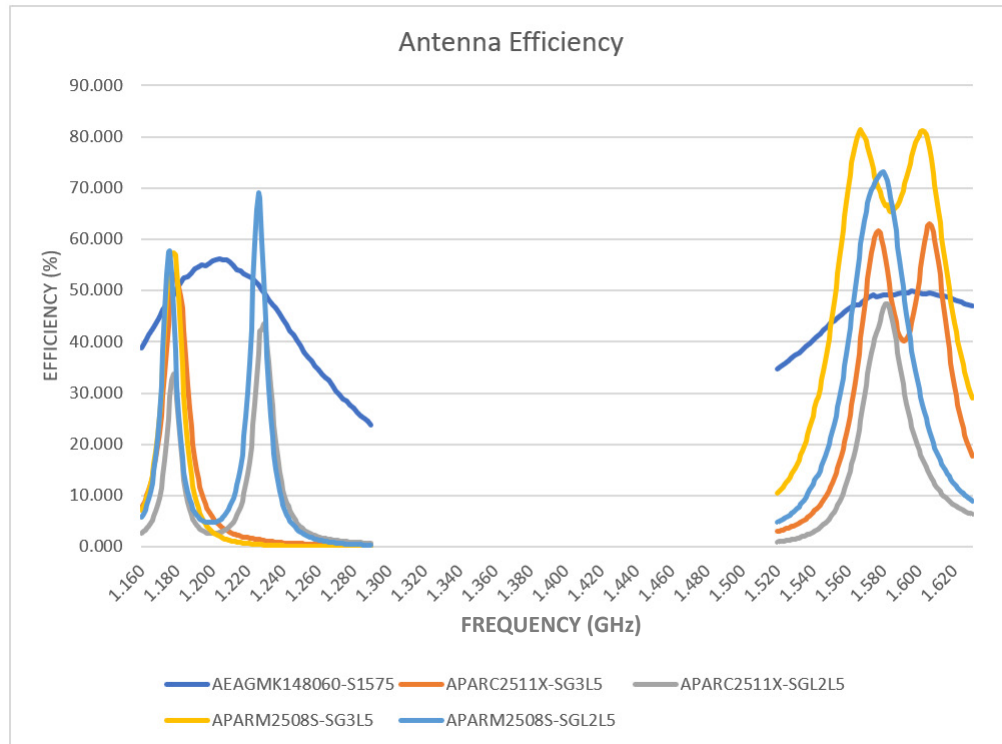

Figure 11: Efficiency plot of all Abracon antennas discussed in this paper

### Stability of Phase Center

For high-precision GNSS/GPS systems, phase center is another critical parameter to consider for external solutions. Ideally, it is the point where an antenna is fed with power versus where the electromagnetic wave falls on the antenna. It is also the point that determines the location of a target. However, in practical applications, the phase center of the antenna varies with respect to the frequency and the phase of the wave being captured. Hence, it is important to retain a stable phase center with lower deviation to reduce the phase center error.

Abracon’s AEAGMK148060-S1575 antenna is designed with adoptable stable symmetric multi-feed forward technology to offer a stable phase center and a low error of 2 mm (maximum). This lower index makes this product ideal for high-precision measurement, surveying and UAV applications.

## 6. Advantages of Using Multi-band GNSS

### Interference and Jamming Rejection

The L1 and L2 bands are prone to signal jamming because they are shared for military use and ground radar, respectively. However, the GPS L5 band supports only the civilian applications, and jamming of signals is less common. Also, the signal transmitted in the L5 band carries twice as much power as the GPS L1 signal. This proves useful to achieve improved performance.

Since most GNSS receivers use the GPS L1 band, interference of signals may be common in some locations. GPS L2 and L5 are more stable and pacify the impact of local interferences.

Additionally, the contemporary trends of PCB miniaturization have posed various concerns upon internal antenna performance. In these scenarios, external antennas, along with built-in pre-filters and LNAs, play an effective role in maximizing the Signal to Interference plus Noise Ratio (SNIR) and the received signal strength (RSSI).

## Mitigation of Ionospheric Delay

A higher frequency signal is less affected by ionospheric effect compared to lower frequencies. It is described by the following expression (Klobuchar 1983 in Brunner and Welsch, 1993) [13]:

$$v = \frac{40.3 \times \text{TEC}}{cf^2}$$

Where  $v$  = ionospheric delay,  $c$  = speed of light (m/s),  $f$  = frequency of the wave (Hz), TEC = quantity of free electrons/sq. meter

The GPS L1 band operating at 1575.42 MHz is therefore less affected, and it experiences a lesser ionospheric delay than the L5 lower band operating at 1176.45 MHz or the L2 band operating at 1227.6 MHz. So, the multi-band receivers have an advantage over receivers that support only a single band. For instance, the frequency separation between L1 and L5 or L1 and L2 is large enough to identify the ionospheric group delay and significantly lessen the errors. In turn, it may be possible to achieve around 5m to 10m positional accuracy with some level of consistency [2]. As discussed earlier, Abracon offers a variety of antennas for such receiver types operating in multiple bands.

## 7. Conclusion

GNSS/GPS protocols are being employed in most navigation and positioning systems. Antennas are critical in establishing and maintaining the communication between satellites and receivers. Before choosing an antenna for an application, operational band(s) for the receiver and the antenna must be carefully evaluated. Additionally, space allocation for the antenna must be carefully determined to retain the maximum available space that will produce the best results. When using an internal antenna, proper layout guidelines must be strictly observed in order to ensure proper antenna operation. For any application, the antenna must have an unobstructed, clear view toward the sky to enable best reception for the antenna from satellites. The choice of an antenna design with right-hand circular polarization gives an advantage in obtaining better received signal quality and in minimizing losses. An antenna with directional characteristics also may add more value to systems than ones with omnidirectional characteristics, especially for applications in densely wooded areas and noisy urban environments.

Abracon's antennas are designed with high gain and low loss LNAs, right-hand CP, and stable adoptable phase center techniques to mitigate multipath signals and interference. The advanced GNSS solutions covered in this paper offer excellent performance for various IoT applications, including UAVs, M2M, precision agriculture, surveying and mapping. The variety of antennas offered with fully customizable cable and connector options (when applicable) allow users to choose the best solution that suits their

applications.

For any technical queries, please reach out to the Abracon's technical team using the following link:  
<https://abracon.com/support/tech-support-form>

For optimization service, please follow the link: <https://abracon.com/antenna-optimization-service>

Author Information:  
**Roshni Prasad**  
Associate Engineer – RF & Connectivity  
Abracon, LLC

## References

- [1] National Coordination Office for Space-Based Positioning, Navigation, and Timing. "GPS Applications." GPS.gov. Available: <https://www.gps.gov/applications/> (accessed Sept. 23, 2020).
- [2] J. Van Sickle. GPS and GNSS for Geospatial Professionals: L2C and CNAV [Online]. John A. Dutton e-Education Institute, College of Earth and Mineral Sciences, The Pennsylvania State Univ. Available: <https://www.e-education.psu.edu/geog862/node/1863> (accessed Sept. 23, 2020).
- [3] J. Van Sickle. GPS and GNSS for Geospatial Professionals: L5 [Online]. John A. Dutton e-Education Institute, College of Earth and Mineral Sciences, The Pennsylvania State Univ. Available: <https://www.e-education.psu.edu/geog862/node/1864> (accessed Sept. 23, 2020).
- [4] B. W. Parkinson and J. J. Spilker, Global Positioning System: Theory and Applications, Vol. II. Washington, D.C., USA: American Institute of Aeronautics and Astronautics, Inc., 1996.
- [5] MathWorks, Inc. "Noise in RF Systems." MathWorks. <https://www.mathworks.com/help/simrf/ug/noise-in-rf-systems.html> (accessed Sept. 23, 2020).
- [6] H. Altan., "Dual Antenna Use on a GPS Receiver," in International Telemetry Conference Proceedings, 2008. [Online]. Available: [https://repository.arizona.edu/bitstream/handle/10150/606154/ITC\\_2008\\_08-02-01.pdf?sequence=1&isAllowed=y](https://repository.arizona.edu/bitstream/handle/10150/606154/ITC_2008_08-02-01.pdf?sequence=1&isAllowed=y).
- [7] EverythingRF. "Stability factor." Microwave101.com. Available: <https://www.microwaves101.com/encyclopedias/stability-factor#conditional> (accessed Sept. 23, 2020).
- [8] P.J. Bevelacqua. "Antenna to Antenna Isolation." Antenna-theory.com. Available: <http://www.antenna-theory.com/definitions/isolation.php> (accessed Sept. 23, 2020).
- [9] L. Heng, T. Walter, P. Enge, and G. X. Gao. (2013). Overcoming RFI with High Mask Angle Antennas and Multiple GNSS Constellations [Online]. Available: [https://web.stanford.edu/~gracegao/publications/conference/2013\\_ION%20GNSS\\_Liang\\_RFT%20mask%20angle.pdf](https://web.stanford.edu/~gracegao/publications/conference/2013_ION%20GNSS_Liang_RFT%20mask%20angle.pdf) (accessed Sept. 23, 2020).
- [10] S. Xue and Y. Yang, "Understanding GDOP minimization in GNSS positioning: Infinite solutions, finite solutions and no solution," Adv. Space Res., vol. 59, no. 3, pp. 775-785 (2016), Feb. 2017. Accessed: Sept. 23, 2020. [Online]. Available: <http://dx.doi.org/10.1016/j.asr.2016.10.019>
- [11] P.D. Groves, Principles of GNSS, Inertial, and Multisensor Integrated Navigation Systems, 2nd ed. Artech House, 2013.
- [12] V. Pathak, S. Thornwall, M. Krier, S. Rowson, G. Poilasne and L. Desclos, "Mobile handset system performance comparison of a linearly polarized GPS internal antenna with a circularly polarized antenna," IEEE Antennas and Propagation Society International Symposium. Digest. Held in conjunction with: USNC/CNC/URSI North American Radio Sci. Meeting (Cat. No.03CH37450), Columbus, OH, 2003, pp. 666-669 vol.3, doi: 10.1109/APS.2003.1219935.
- [13] J. Van Sickle. GPS and GNSS for Geospatial Professionals: The Ionospheric Effect [Online]. John A. Dutton e-Education Institute, College of Earth and Mineral Sciences, The Pennsylvania State Univ. Available: <https://www.e-education.psu.edu/geog862/node/1715> (accessed Sept. 23, 2020).
- [14] B. Rama Rao, W. Kunysz, R. Fante, and K. McDonald, GPS/GNSS Antennas. Artech House, 2013.
- [15] A. R. Lopez, "GPS Landing System Reference Antenna," in IEEE Antennas and Propagation Magazine, vol. 52, no. 1, pp. 104-113, Feb. 2010, doi: 10.1109/MAP.2010.5466404.
- [16] "GPS World Receiver Survey," GPS World. [Online]. Available: <https://www.gpsworld.com/resources/gps-world-receiver-survey/> (accessed Sept. 23, 2020).