

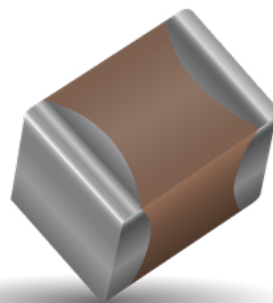

Mil PRF 32535, NASA, European Space Agency and CECC Approved Ceramic Capacitor Products

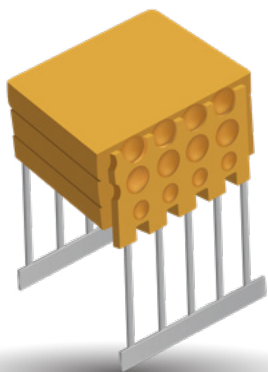

IMPORTANT INFORMATION/DISCLAIMER

All product specifications, statements, information and data (collectively, the “Information”) in this datasheet or made available on the website are subject to change. The customer is responsible for checking and verifying the extent to which the Information contained in this publication is applicable to an order at the time the order is placed. All Information given herein is believed to be accurate and reliable, but it is presented without guarantee, warranty, or responsibility of any kind, expressed or implied.

Statements of suitability for certain applications are based on KYOCERA AVX’s knowledge of typical operating conditions for such applications, but are not intended to constitute and KYOCERA AVX specifically disclaims any warranty concerning suitability for a specific customer application or use.

ANY USE OF PRODUCT OUTSIDE OF SPECIFICATIONS OR ANY STORAGE OR INSTALLATION INCONSISTENT WITH PRODUCT GUIDANCE VOIDS ANY WARRANTY.

The Information is intended for use only by customers who have the requisite experience and capability to determine the correct products for their application. Any technical advice inferred from this Information or otherwise provided by KYOCERA AVX with reference to the use of KYOCERA AVX’s products is given without regard, and KYOCERA AVX assumes no obligation or liability for the advice given or results obtained.

Although KYOCERA AVX designs and manufactures its products to the most stringent quality and safety standards, given the current state of the art, isolated component failures may still occur. Accordingly, customer applications which require a high degree of reliability or safety should employ suitable designs or other safeguards (such as installation of protective circuitry or redundancies) in order to ensure that the failure of an electrical component does not result in a risk of personal injury or property damage.

Unless specifically agreed to in writing, KYOCERA AVX has not tested or certified its products, services or deliverables for use in high risk applications including medical life support, medical device, direct physical patient contact, water treatment, nuclear facilities, weapon systems, mass and air transportation control, flammable environments, or any other potentially life critical uses. Customer understands and agrees that KYOCERA AVX makes no assurances that the products, services or deliverables are suitable for any high-risk uses. Under no circumstances does KYOCERA AVX warrant or guarantee suitability for any customer design or manufacturing process.

Although all product-related warnings, cautions and notes must be observed, the customer should not assume that all safety measures are indicated or that other measures may not be required.

European Space Agency and CECC Approved Ceramic Capacitor Products



Table of Contents

Mil PRF 32535 BME X7R MLCCs	1
Defense Logistics Agency Approved	
Mil PRF 32535 BME NPO MLCCs	4
Defense Logistics Agency Approved	
NASA Space Level BME X7R MLCC	7
S311-P838 Approved	
QPL Space Level BME X7R	11
ESCC QPL 3009/041 Approved	
Engineering Module (EM) Range X7R BME MLCC for Non Flight Prototype	16
Design Covering ESCC 3009041, NASA S311-P838 and Mil 32535 Ranges Design Covering Mil 32535 NP0 Ranges	
QPL ESCC 3009 and CECC Surface Mount MLCC, Type I & II	20
ESCC Qualified SMPS Capacitors	33
High Voltage Chip/Leaded Capacitors High Capacitance	
SMPS LVT Details & Physical Dimensions	36
QPL Certificates	41

All products to be considered Not RoHS Compliant unless otherwise indicated.



Mil PRF 32535 BME X7R MLCCs

Defense Logistics Agency Approved

MIL PRF 32535 BME X7R MLCC

Defense Logistics Agency Approved

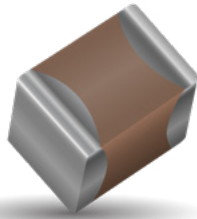

KYOCERA AVX has been approved by the Defense Logistics Agency (DLA) for its qualification of its Mil Prf 32535 BME X7R MLCC technology. Using its leading edge technology KYOCERA AVX can now offer Mil Prf 32535 approved capacitors from 0402 to 2220 case sizes. With capacitance & voltage ranges ranging from 2.2nF to 22μF, 16–100 volts, currently. KYOCERA AVXs Mil Prf 32535 meets the designer needs by boosting the CV range compared to the standard surface mount Mil Ranges and reduces the gap between commercial and Mil Spec product ranges while meeting the Mil reliability levels. The results of this technology has several key benefits for the Mil design engineer resulting in , ability to downsize case sizes, reducing PCB weight and allowing more efficient use of the PCB area available with the higher CV MLCCs. These surface mount components also incorporate Flexitem® , which greatly enhances resistance to any of the thermo-mechanical stress experienced by MLCCs during PCB assembly and during its life time.

FEATURES

- “M” and “T” reliability levels available.
- Higher CV capability than standard Mil based capacitors resulting in reduced size/weight of components and saving in PCB space required.
- Flexitem® technology used as standard in range for enhanced thermo-mechanical stress resistance.
- Case sizes 0402-2220, cap values 2.2nF–22.0μF available.
- Voltages 16-100 Volts

HOW TO ORDER

M32535	08	E2	Z	226	K	R	M	B
Mil Spec M32535	Slash Sheet Number 02 = 0402 03 = 0603 04 = 0805 05 = 1206 06 = 1210 07 = 1812 08 - 2220	Characteristic E2 (X7R ± 15%)	Voltage Y = 16V Z = 25V A = 50V B = 100V	Capacitance 682 = 6.8nF 103 = 10nF 474 = 470nF 475 = 4.7μF 226 = 22μF	Tolerance J = ±5% K = ±10% M = ±20%	Termination R = Epoxy Ni Sn/Pb	Product Level M = Standard T = Space Level	Electrode B = BME

Please note all parts are terminated with a minimum 10% Pb plating.

DIMENSIONS

mm (inches)

Size	M3253502		M3253503		M3253504		M3253505		M3253506		M3253507		M3253508	
	0402		0603		0805		1206		1210		1812		2220	
	Min.	Max.	Min.	Max.	Min.	Max.	Min.	Max.	Min.	Max.	Min.	Max.	Min.	Max.
(L) Length	0.92 (0.036)	1.12 (0.044)	1.45 (0.057)	1.75 (0.069)	1.79 (0.069)	2.26 (0.089)	3.00 (0.118)	3.45 (0.136)	2.94 (0.116)	3.45 (0.136)	4.19 (0.165)	4.80 (0.190)	5.2 (0.208)	6.1 (0.24)
(W) Width	0.41 (0.016)	0.61 (0.024)	0.66 (0.026)	0.97 (0.038)	1.01 (0.040)	1.52 (0.060)	1.35 (0.053)	1.85 (0.073)	2.25 (0.088)	2.74 (0.108)	2.89 (0.114)	3.50 (0.138)	4.59 (0.181)	5.41 (0.213)
(T) Thickness	0.61 (0.24) Max.		0.99 (0.039) Max.		1.52 (0.060)		1.78 (0.070) Max.		2.80 (0.110) Max.		2.80 (0.110) Max.		2.80 (0.110) Max.	
(t) terminal	0.1 (0.004)	0.30 (0.012)	0.20 (0.008)	0.61 (0.024)	0.25 (0.010)	0.75 (0.030)	0.15 (0.006)	0.86 (0.034)	0.15 (0.006)	0.86 (0.034)	0.15 (0.006)	1.1 (0.042)	0.17 (0.007)	1.09 (0.043)

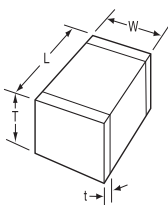

MIL PRF 32535 BME X7R MLCC

Defense Logistics Agency Approved



MIL PRF 32535 X7R APPROVED RANGE

Mil		M3253502			M3253503			M3253504			M3253505			M3253506			M3253507			M3253508		
Case Sizes		0402			0603			0805			1206			1210			1812			2220		
Code	Value	16/25V	50V	100V	16/25V	50V	100V	16/25V	50V	100V	16/25V	50V	100V	16/25V	50V	100V	16/25V	50V	100V	16/25V	50V	100V
222	2.2 (nF)																					
272	2.7																					
332	3.3																					
392	3.9																					
472	4.7																					
562	5.6																					
682	6.8																					
822	8.2																					
103	10																					
123	12																					
153	15																					
183	18																					
223	22																					
273	27																					
333	33																					
393	39																					
473	47																					
563	56																					
683	68																					
823	82																					
104	100																					
124	120																					
154	150																					
184	180																					
224	220																					
274	270																					
334	330																					
394	390																					
474	470																					
564	560																					
684	680																					
824	820																					
105	1 (µF)																					
125	1.2																					
155	1.5																					
185	1.8																					
225	2.2																					
275	2.7																					
335	3.3																					
395	3.9																					
475	4.7																					
565	5.6																					
685	6.8																					
825	8.2																					
106	10																					
126	12																					
156	15																					
186	18																					
226	22																					



Mil PRF 32535 BME NPO MLCCs

Defense Logistics Agency Approved

MIL PRF 32535 BME NPO MLCC

Defense Logistics Agency Approved

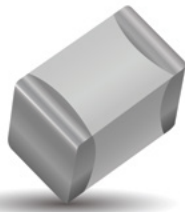

KYOCERA AVX has been approved by the Defense Logistics Agency (DLA) for its qualification of its Mil Prf 32535 BME NPO MLCC technology. Using its leading edge technology KYOCERA AVX can now offer Mil Prf 32535 NPO approved capacitors in 0402,0603,0805 case sizes with capacitance & voltage ranges ranging from 68 pF to 1500 pF, 10 –100 volts, currently. KYOCERA AVX Mil Prf 32535 NPO meets the designer needs by boosting the CV range compared to the standard surface mount Mil Ranges and reduces the gap between commercial and Mil Spec product ranges while meeting the Mil reliability levels. The results of this technology has several key benefits for the Mil design engineer resulting in , ability to downsize case sizes, reducing PCB weight and allowing more efficient use of the PCB area available with the higher CV MLCCs. These surface mount components also incorporate Flexiterm®, which greatly enhances resistance to any of the thermo-mechanical stress experienced by MLCCs during PCB assembly and during its life time.

FEATURES

- “M” and “T” reliability levels available.
- Higher CV capability than standard Mil based capacitors resulting in reduced size/weight of components and saving in PCB space required.
- Flexiterm® technology used as standard in range for enhanced thermo-mechanical stress resistance.
- Case sizes 0402-0603-0805 currently, cap values 68pF–1500 pF available.
- Voltages 4 -100 Volts

HOW TO ORDER

M32535	03	E1	A	152	K	R	T	B
Mil Spec M32535	Slash Sheet Number 02 = 0402 03 = 0603 04 = 0805 05 = 1206 06 = 1210 07 = 1812 08 - 2220	Characteristic E1 COG 0±30ppm/°C	Voltage 4V = V 6.3V = W 10V = X 16V = Y 25V = Z 50V = A 100V = B	Capacitance First two digits represents significant figures and last digit for number of zeros to follow 152=1500 pf	Tolerance F = ±1% G = ±2% J = ±5% K = ±10%	Termination R = Epoxy Ni Sn/Pb	Product Level M = Standard T = Space Level	Electrode B = BME

Packaging, Waffle as standard, for Tape and Reel add \1 to end of the part number, e.g. M3253503E1Z152KRTB\1

Please note all parts are terminated with a minimum 10% Pb plating.

DIMENSIONS

mm (inches)

Size	M3253502		M3253503		M3253504		M3253505		M3253506		M3253507		M3253508	
	0402		0603		0805		1206		1210		1812		2220	
	Min.	Max.	Min.	Max.	Min.	Max.	Min.	Max.	Min.	Max.	Min.	Max.	Min.	Max.
(L) Length	0.92 (0.036)	1.12 (0.044)	1.45 (0.057)	1.75 (0.069)	1.79 (0.069)	2.26 (0.089)	3.00 (0.118)	3.45 (0.136)	2.94 (0.116)	3.45 (0.136)	4.19 (0.165)	4.80 (0.190)	5.2 (0.208)	6.1 (0.24)
(W) Width	0.41 (0.016)	0.61 (0.024)	0.66 (0.026)	0.97 (0.038)	1.01 (0.040)	1.52 (0.060)	1.35 (0.053)	1.85 (0.073)	2.25 (0.088)	2.74 (0.108)	2.89 (0.114)	3.50 (0.138)	4.59 (0.181)	5.41 (0.213)
(T) Thickness	0.61 (0.24) Max.		0.99 (0.039) Max.		1.52 (0.060)		1.78 (0.070) Max.		2.80 (0.110) Max.		2.80 (0.110) Max.		2.80 (0.110) Max.	
(t) terminal	0.1 (0.004)	0.30 (0.012)	0.20 (0.008)	0.61 (0.024)	0.25 (0.010)	0.75 (0.030)	0.15 (0.006)	0.86 (0.034)	0.15 (0.006)	0.86 (0.034)	0.15 (0.006)	1.1 (0.042)	0.17 (0.007)	1.09 (0.043)

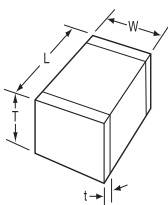

MIL PRF 32535 BME NPO MLCC

Defense Logistics Agency Approved



MIL PRF 32535 NPO APPROVED RANGE

Mil			M3253502					M3253503					M3253504				
Case Sizes			0402					0603					0805				
Code	Value	Cap Tol	4-10 V	16 V	25 V	50 V	100 V	4-10 V	16 V	25 V	50 V	100 V	4-10 V	16 V	25 V	50 V	100 V
680	68 pF	F,G,J,K															
820	82 pF	F,G,J,K															
101	100 pF	F,G,J,K															
121	120 pF	F,G,J,K															
151	150 pF	F,G,J,K															
181	180 pF	F,G,J,K															
221	220 pF	F,G,J,K															
271	270 pF	F,G,J,K															
331	330 pF	F,G,J,K															
391	390 pF	F,G,J,K															
471	470 pF	F,G,J,K															
561	560 pF	F,G,J,K															
681	680 pF	F,G,J,K															
821	820 pF	F,G,J,K															
102	1000pF	F,G,J,K															
122	1200pF	F,G,J,K															
152	1500pF	F,G,J,K															
182	1800pF	F,G,J,K															
202	2000pF	F,G,J,K															
222	2200pF	F,G,J,K															
272	2700pF	F,G,J,K															
332	3300pF	F,G,J,K															
392	3900pF	F,G,J,K															
472	4700pF	F,G,J,K															



NASA Space Level BME X7R MLCC S311-P838 Approved

NASA Space Level BME X7R MLCC

S311-P838 Approved

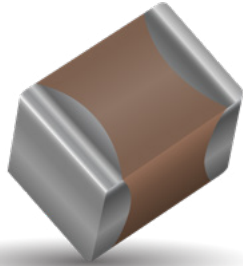

KYOCERA AVX is the first company to be awarded the NASA S311-P838 specification for its Space BME X7R MLCC technology. This technology delivers an advanced capacitance voltage capability compared to conventional PME (Precious Metal Electrode) technologies while meeting the reliability levels demanded by NASA's space industry. The technology has several key benefits, downsizing case sizes, reducing weight and allowing more efficient use of the PCB area available. The range is tested using Mil spec standards and methods including 100% ultrasonic examination in compliance with the NASA space specification. These surface mount components also incorporate Flexiterm[®], which greatly enhances resistance to any of the mechanical stress experienced by MLCCs during PCB assembly and in operation.

FEATURES

- Higher CV capability than standard capacitors resulting in reduced size / weight of components and saving in PCB space required.
- Every production lot will have a C of C, DPA and a summary data package.
- Use of Flexiterm[®] technology for enhanced mechanical stress resistance.
- Case sizes: 0603 - 1812, cap values 2.2nF - 8.2uF available.
- Voltages: 16 - 100 Volts

HOW TO ORDER

G311P838

GSFC Identifier

A

Ultrasonic Examination
A = 100%

F

Size Code
A = 0402
B = 0603
C = 0805
D = 1206
E = 1210
F = 1812

X

Dielectric Type
X = X7R

825

Capacitance in pF
2 significant digits + number of zeros
e.g.
103 = 10nF
225 = 2.2μF

J

Tolerance
J = ±5%
K = ±10%
M = ±20%

1

Voltage
1 = 25Vdc
2 = 50Vdc
3 = 100Vdc
6 = 16Vdc

R

Termination
R = Sn/Pb plated

3

Packaging/ Marking
1 = T/R unmarked capacitors
2 = T/R marked capacitors
3 = Waffle Pack, unmarked capacitors
4 = Waffle Pack, marked capacitors

Please note all parts are terminated with a minimum 10% Pb plating.

DIMENSIONS

mm (inches)

Size	0603		0805		1206		1210		1812	
	Min.	Max.	Min.	Max.	Min.	Max.	Min.	Max.	Min.	Max.
(L) Length	1.48 (0.058)	1.75 (0.069)	1.79 (0.070)	2.29 (0.090)	3.00 (0.118)	3.40 (0.134)	3.00 (0.118)	3.40 (0.134)	4.19 (0.165)	4.95 (0.195)
(W) Width	0.66 (0.026)	0.97 (0.038)	1.01 (0.040)	1.45 (0.057)	1.40 (0.055)	1.80 (0.071)	2.25 (0.088)	2.70 (0.108)	2.79 (0.115)	3.56 (0.140)
(T) Thickness	1.02 (0.040) Max.		1.52 (0.060) Max.		1.80 (0.071) Max.		2.80 (0.110) Max.		2.80 (0.110) Max.	
(t) terminal	0.20 (0.008)	0.50 (0.020)	0.25 (0.010)	0.75 (0.030)	0.25 (0.010)	0.75 (0.030)	0.25 (0.010)	0.75 (0.030)	0.25 (0.010)	0.95 (0.037)

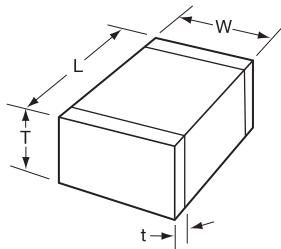

NASA Space Level BME X7R MLCC

S311-P838 Approved



PREFERRED SIZES ARE SHADED

Case Sizes		B (0603)				C (0805)				D (1206)				E (1210)				F (1812)				
Code	Value	16V	25V	50V	100V	16V	25V	50V	100V	16V	25V	50V	100V	16V	25V	50V	100V	16V	25V	50V	100V	
222	2.2 (nF)																					
272	2.7																					
332	3.3																					
392	3.9																					
472	4.7																					
562	5.6																					
682	6.8																					
822	8.2																					
103	10																					
123	12																					
153	15																					
183	18																					
223	22																					
273	27																					
333	33																					
393	39																					
473	47																					
563	56																					
683	68																					
823	82																					
104	100																					
124	120																					
154	150																					
184	180																					
224	220																					
274	270																					
334	330																					
394	390																					
474	470																					
564	560																					
684	680																					
824	820																					
105	1 (µF)																					
125	1.2																					
155	1.5																					
185	1.8																					
225	2.2																					
275	2.7																					
335	3.3																					
395	3.9																					
475	4.7																					
565	5.6																					
685	6.8																					
825	8.2																					
106	10																					

NASA Space Level BME X7R MLCC

S311-P838 Approved



ELECTRICAL MEASUREMENTS AT ROOM TEMPERATURE

Charateristics	Symbol	Test Method and Conditions	Tolerance (± %)	Limits		Unit
				Min.	Max.	
Capacitance	C _A	MIL-STD-202 Method 305 25°C, 1KHz, 1Vrms	5	0.95C _n	1.05C _n	pF
			10	0.9C _n	1.1C _n	
			20	0.8C _n	1.2C _n	
Insulation Resistance	R _I	MIL-STD-202 Method 302 120 sec, 25°C For C _n ≤ 10000pF: For C _n > 10000pF:	All	100	–	GΩ
				1000	–	GΩ nF
Dissipation Factor	Df	Measured 25°C, 1KHz, 1Vrms, 16-25 Volts > 25 Volts	All		3.5	%
					2.5	%
Voltage Proof	VP	MIL-STD-202 Method 301 60 sec	All	2.5U _R	–	V

ELECTRICAL MEASUREMENTS AT HIGH AND LOW TEMPERATURE

Charateristics	Symbol	Test Method and Conditions (Note 1)	Limits		Unit
			Min.	Max.	
Insulation Resistance	R _I	MIL-STD-202 Method 302 For C _n ≤ 10000pF: For C _n > 10000pF:	100	–	GΩ
			1000		GΩ nF



QPL Space Level BME X7R

ESCC QPL 3009/041 Approved

Space Level BME X7R MLCC

ESCC QPL 3009/041 Approved

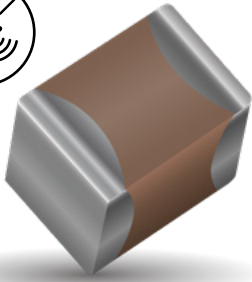

The KYOCERA AVX Space , 3009041, BME (Base Metal Electrode) X7R surface mount MLCC QPL approved since 2015. The technology utilizes the leading edge technology in MLCC construction and processing. This technology delivers high reliability with a superior capacitance voltage capability compared values in the smaller case sizes not only reduces the amount of board space used but also the weight of components. The surface mount components also incorporate Flexiterm[®], which greatly improves the resistance to the mechanical stress experienced by MLCCs either during assembly or during the product life time. Flexiterm[®] technology provides greater protection against board flexure and promotes an open circuit failure mode under PCB bend testing.

BENEFITS

- Space BME enables customers to down size MLCCs and save PCB space.
- The Space BME range provides a high CV range 16 – 100 volts, 2.2 n F – 22 u F
- The range comes with Flexiterm[®] termination which protection against board flexure either during assembly or product lifetime.

HOW TO ORDER

3009041	07	226	J	E
Detailed Spec 3009041	Component Variant	Capacitance Code 2 significant digits + number of zeros e.g. 103 = 10nF 225 = 2.2µF 226 = 22µF	Capacitance Tolerance J = 5% K = 10% M = 20%	Voltage X = 16V A = 25V C = 50V E = 100V
	01 (0402) 02 (0603) 03 (0805) 04 (1206) 05 (1210) 06 (1812) 07 (2220)			

Please note all parts are terminated with a minimum 10% Pb plating. Parts packed in waffles as standard, tape and reel available upon request.

Lot Validation Testing (LVT) can be ordered separately, LVT Groups 3, 2b, 2a, 1.

DIMENSIONS

mm (inches)

Size	0402		0603		0805		1206		1210		1812		2220	
	Min.	Max.	Min.	Max.	Min.	Max.	Min.	Max.	Min.	Max.	Min.	Max.	Min.	Max.
(L) Length	0.90 (0.035)	1.15 (0.045)	1.45 (0.057)	1.75 (0.069)	1.80 (0.071)	2.20 (0.087)	3.00 (0.118)	3.40 (0.134)	3.00 (0.118)	3.40 (0.134)	4.20 (0.165)	4.80 (0.189)	5.3 (0.208)	6.1 (0.24)
(W) Width	0.41 (0.016)	0.61 (0.024)	0.65 (0.026)	0.95 (0.037)	1.05 (0.041)	1.45 (0.057)	1.40 (0.055)	1.80 (0.071)	2.30 (0.091)	2.70 (0.106)	3.00 (0.118)	3.40 (0.124)	4.60 (0.18)	5.41 (0.213)
(T) Thickness	0.61 Max. (0.024)		1.00 Max. (0.039)		1.52 Max. (0.060)		1.80 Max. (0.071)		2.80 Max. (0.110)		2.80 Max. (0.110)		2.80 Max. (0.110)	
(t) terminal	0.1 (0.004)	0.40 (0.015)	0.20 (0.008)	0.50 (0.020)	0.25 (0.010)	0.75 (0.030)	0.25 (0.010)	0.75 (0.030)	0.25 (0.010)	0.75 (0.030)	0.25 (0.010)	0.95 (0.037)	0.25 (0.009)	1.03 (0.041)

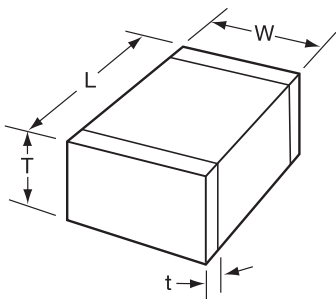

Space Level BME X7R MLCC

ESCC QPL 3009/041 Approved



PREFERRED SIZES ARE SHADED

Case Sizes		0402			0603			0805			1206			1210			1812			2220		
Code	Value	16/25V	50V	100V	16/25V	50V	100V	16/25V	50V	100V	16/25V	50V	100V	16/25V	50V	100V	16/25V	50V	100V	16/25V	50V	100V
222	2.2 (nF)	Shaded	Shaded	Shaded	Shaded	Shaded	Shaded															
272	2.7	Shaded	Shaded	Shaded	Shaded	Shaded	Shaded															
332	3.3	Shaded	Shaded	Shaded	Shaded	Shaded	Shaded															
392	3.9	Shaded	Shaded	Shaded	Shaded	Shaded	Shaded															
472	4.7	Shaded	Shaded	Shaded	Shaded	Shaded	Shaded	Shaded	Shaded	Shaded												
562	5.6	Shaded	Shaded	Shaded	Shaded	Shaded	Shaded	Shaded	Shaded	Shaded												
682	6.8	Shaded	Shaded	Shaded	Shaded	Shaded	Shaded	Shaded	Shaded	Shaded												
822	8.2	Shaded	Shaded	White	Shaded	Shaded	Shaded	Shaded	Shaded	Shaded												
103	10	Shaded	Shaded	White	Shaded	Shaded	Shaded	Shaded	Shaded	Shaded												
123	12	Shaded	Shaded	White	Shaded	Shaded	Shaded	Shaded	Shaded	Shaded												
153	15	Shaded	Shaded	White	Shaded	Shaded	Shaded	Shaded	Shaded	Shaded												
183	18	Shaded	Shaded	White	Shaded	Shaded	Shaded	Shaded	Shaded	Shaded	Shaded	Shaded	Shaded									
223	22	Shaded	Shaded	White	Shaded	Shaded	White	Shaded	Shaded	Shaded	Shaded	Shaded	Shaded									
273	27	Shaded	Shaded	White	Shaded	Shaded	Shaded	Shaded	Shaded	Shaded												
333	33	Shaded	White	White	Shaded	Shaded	Shaded	Shaded	Shaded	Shaded												
393	39	White	White	White	Shaded	Shaded	White	Shaded	Shaded	Shaded												
473	47	White	White	White	Shaded	Shaded	White	Shaded	Shaded	Shaded	Shaded	Shaded	Shaded									
563	56	White	White	White	Shaded	Shaded	White	Shaded	Shaded	Shaded	Shaded	Shaded	Shaded	Shaded	Shaded	Shaded						
683	68	White	White	White	Shaded	Shaded	White	Shaded	Shaded	Shaded	Shaded	Shaded	Shaded	Shaded	Shaded	Shaded						
823	82	White	White	White	Shaded	Shaded	White	Shaded	Shaded	Shaded	Shaded	Shaded	Shaded	Shaded	Shaded	Shaded						
104	100	White	White	White	Shaded	Shaded	White	Shaded	Shaded	Shaded	Shaded	Shaded	Shaded	Shaded	Shaded	Shaded						
124	120	White	White	White	Shaded	Shaded	White	Shaded	Shaded	White	Shaded	Shaded	Shaded	Shaded	Shaded	Shaded						
154	150	White	White	White	Shaded	White	White	Shaded	Shaded	Shaded	Shaded	Shaded	Shaded	Shaded	Shaded	Shaded	Shaded	Shaded	Shaded			
184	180	White	White	White	Shaded	White	White	Shaded	Shaded	Shaded	Shaded	Shaded	Shaded	Shaded	Shaded	Shaded	Shaded	Shaded	Shaded	Shaded	Shaded	Shaded
224	220	White	White	White	Shaded	White	White	Shaded	Shaded	Shaded	Shaded	Shaded	Shaded	Shaded	Shaded	Shaded	Shaded	Shaded	Shaded	Shaded	Shaded	Shaded
274	270	White	White	White	Shaded	White	White	Shaded	Shaded	Shaded	Shaded	Shaded	Shaded	Shaded	Shaded	Shaded	Shaded	Shaded	Shaded	Shaded	Shaded	Shaded
334	330	White	White	White	Shaded	White	White	Shaded	Shaded	Shaded	Shaded	Shaded	Shaded	Shaded	Shaded	Shaded	Shaded	Shaded	Shaded	Shaded	Shaded	Shaded
394	390	White	White	White	Shaded	White	White	Shaded	Shaded	Shaded	Shaded	Shaded	Shaded	Shaded	Shaded	Shaded	Shaded	Shaded	Shaded	Shaded	Shaded	Shaded
474	470	White	White	White	Shaded	White	White	Shaded	Shaded	Shaded	Shaded	Shaded	Shaded	Shaded	Shaded	Shaded	Shaded	Shaded	Shaded	Shaded	Shaded	Shaded
564	560	White	White	White	Shaded	White	White	Shaded	Shaded	Shaded	Shaded	Shaded	Shaded	Shaded	Shaded	Shaded	Shaded	Shaded	Shaded	Shaded	Shaded	Shaded
684	680	White	White	White	Shaded	White	White	Shaded	Shaded	Shaded	Shaded	Shaded	Shaded	Shaded	Shaded	Shaded	Shaded	Shaded	Shaded	Shaded	Shaded	Shaded
824	820	White	White	White	Shaded	White	White	Shaded	Shaded	Shaded	Shaded	Shaded	Shaded	Shaded	Shaded	Shaded	Shaded	Shaded	Shaded	Shaded	Shaded	Shaded
105	1 (µF)	White	White	White	Shaded	White	White	Shaded	Shaded	Shaded	Shaded	Shaded	Shaded	Shaded	Shaded	Shaded	Shaded	Shaded	Shaded	Shaded	Shaded	Shaded
125	1.2	White	White	White	Shaded	White	White	Shaded	Shaded	Shaded	Shaded	Shaded	Shaded	Shaded	Shaded	Shaded	Shaded	Shaded	Shaded	Shaded	Shaded	Shaded
155	1.5	White	White	White	Shaded	White	White	Shaded	Shaded	Shaded	Shaded	Shaded	Shaded	Shaded	Shaded	Shaded	Shaded	Shaded	Shaded	Shaded	Shaded	Shaded
185	1.8	White	White	White	Shaded	White	White	Shaded	Shaded	Shaded	Shaded	Shaded	Shaded	Shaded	Shaded	Shaded	Shaded	Shaded	Shaded	Shaded	Shaded	Shaded
225	2.2	White	White	White	Shaded	White	White	Shaded	Shaded	Shaded	Shaded	Shaded	Shaded	Shaded	Shaded	Shaded	Shaded	Shaded	Shaded	Shaded	Shaded	Shaded
275	2.7	White	White	White	Shaded	White	White	Shaded	Shaded	Shaded	Shaded	Shaded	Shaded	Shaded	Shaded	Shaded	Shaded	Shaded	Shaded	Shaded	Shaded	Shaded
335	3.3	White	White	White	Shaded	White	White	Shaded	Shaded	Shaded	Shaded	Shaded	Shaded	Shaded	Shaded	Shaded	Shaded	Shaded	Shaded	Shaded	Shaded	Shaded
395	3.9	White	White	White	Shaded	White	White	Shaded	Shaded	Shaded	Shaded	Shaded	Shaded	Shaded	Shaded	Shaded	Shaded	Shaded	Shaded	Shaded	Shaded	Shaded
475	4.7	White	White	White	Shaded	White	White	Shaded	Shaded	Shaded	Shaded	Shaded	Shaded	Shaded	Shaded	Shaded	Shaded	Shaded	Shaded	Shaded	Shaded	Shaded
565	5.6	White	White	White	Shaded	White	White	Shaded	Shaded	Shaded	Shaded	Shaded	Shaded	Shaded	Shaded	Shaded	Shaded	Shaded	Shaded	Shaded	Shaded	Shaded
685	6.8	White	White	White	Shaded	White	White	Shaded	Shaded	Shaded	Shaded	Shaded	Shaded	Shaded	Shaded	Shaded	Shaded	Shaded	Shaded	Shaded	Shaded	Shaded
825	8.2	White	White	White	Shaded	White	White	Shaded	Shaded	Shaded	Shaded	Shaded	Shaded	Shaded	Shaded	Shaded	Shaded	Shaded	Shaded	Shaded	Shaded	Shaded
106	10	White	White	White	Shaded	White	White	Shaded	Shaded	Shaded	Shaded	Shaded	Shaded	Shaded	Shaded	Shaded	Shaded	Shaded	Shaded	Shaded	Shaded	Shaded
126	12	White	White	White	Shaded	White	White	Shaded	Shaded	Shaded	Shaded	Shaded	Shaded	Shaded	Shaded	Shaded	Shaded	Shaded	Shaded	Shaded	Shaded	Shaded
156	15	White	White	White	Shaded	White	White	Shaded	Shaded	Shaded	Shaded	Shaded	Shaded	Shaded	Shaded	Shaded	Shaded	Shaded	Shaded	Shaded	Shaded	Shaded
186	18	White	White	White	Shaded	White	White	Shaded	Shaded	Shaded	Shaded	Shaded	Shaded	Shaded	Shaded	Shaded	Shaded	Shaded	Shaded	Shaded	Shaded	Shaded
226	22	White	White	White	Shaded	White	White	Shaded	Shaded	Shaded	Shaded	Shaded	Shaded	Shaded	Shaded	Shaded	Shaded	Shaded	Shaded	Shaded	Shaded	Shaded

Space Level BME X7R MLCC

ESCC QPL 3009/041 Approved



ELECTRICAL MEASUREMENTS AT ROOM TEMPERATURE

The measurements shall be performed at $T_{amb} = +22 \pm 3^{\circ}\text{C}$.

Charateristics	Symbol	Test Method and Conditions	Tolerance (\pm %)	Limits		Unit
				Min.	Max.	
Capacitance (Note 1)	C_A	ESCC No. 3009	5 10 20	$0.95C_n$ $0.9C_n$ $0.8C_n$	$1.05C_n$ $1.1C_n$ $1.2C_n$	pF
Tangent of Loss Angle	$tg\delta$	ESCC No. 3009 For $U_R = 50\text{V}, 100\text{V}$: For $U_R = 16\text{V}, 25\text{V}$:	All	- -	250×10^{-4} 300×10^{-4}	- -
Insulation Resistance	R_I	ESCC No. 3009 For $C_n \leq 10000\text{pF}$: For $C_n > 10000\text{pF}$:	All	100 1000	- -	G Ω G Ω nF
Voltage Proof	VP	ESCC No. 3009	All	$2.5U_R$	-	V

NOTE: 1. 300 max for 16 volt and 25 volt rated components

ELECTRICAL MEASUREMENTS AT HIGH AND LOW TEMPERATURE

Charateristics	Symbol	Test Method and Conditions (Note 1)	Limits		Unit
			Min.	Max.	
Insulation Resistance	R_I	ESCC No. 3009 For $C_n \leq 10000\text{pF}$: For $C_n > 10000\text{pF}$:	100 1000	-	G Ω G Ω nF
Temperature Characteristic	TC	ESCC No. 3009 $T_{amb} = -55 \pm 2^{\circ}\text{C}, +20 \pm 2^{\circ}\text{C}, +125 \pm 2^{\circ}\text{C}$ (Note 2 and 3) For VT = no voltage applied:	-15	+15	%

NOTE: 1. Single Sample, Inspection Level S3, AQL = 2.5%
2. If 1 failure out of 5 parts, then test 100%. 1.0% rejects maximum allowed in case of 100% testing.
3. X7R dielectric: Delta C/C at U_R is typically -10% to -70% dependant on capacitance value. (See curves on next page)

LVT 3009041 TEST DETAIL

LVT Group Test Number	LVT 3009041 Test Detail, Parametric Data Recorded	Min No. Of Pcs for Test
3	Solderability	3
2b	PCB Mounting, Capacitance Temperature Characteristics and Robustness of Termination	3
2a	PCB Mounting, Life testing for 1000 hours, 2 x RV @ 125°C	10
1	PCB Mounting, Rapid Change of Temperature, Steady state humidity testing, (1.5 Volts DC @ 85°C / 85% Hum) 1000 hours, external visual inspection	20

Space Level BME X7R MLCC

ESCC QPL 3009/041 Approved



TYPICAL ELECTRICAL CHARACTERISTICS FOR ESCC BME SURFACE MOUNT

CAPACITANCE TEMPERATURE CHARACTERISTICS FOR 0805 STYLE (WITH DC BIAS)

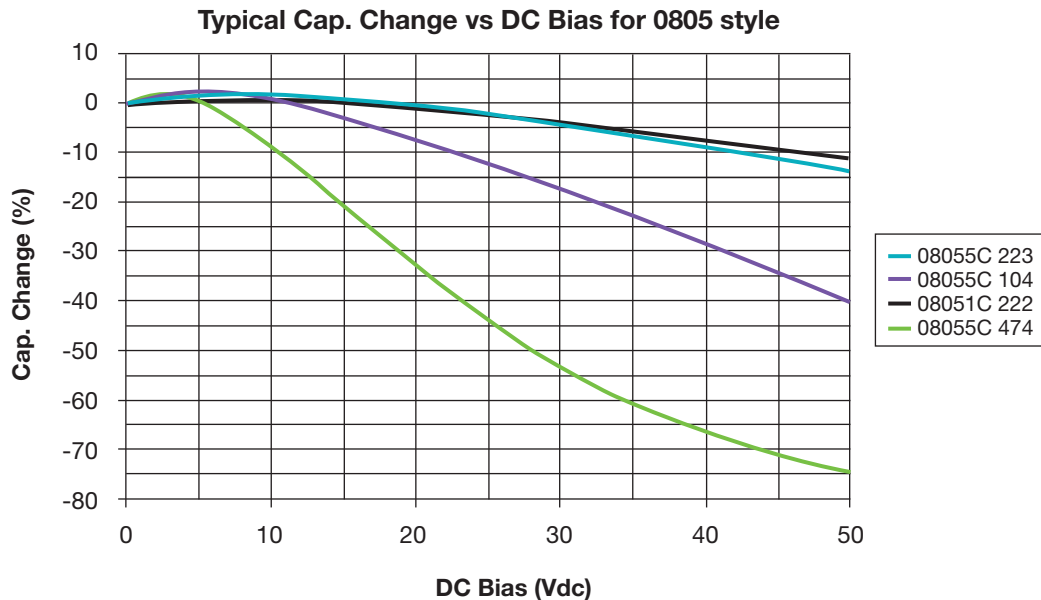

IMPEDANCE WITH ESR CHARACTERISTICS FOR 0805 CAPACITANCE RANGE

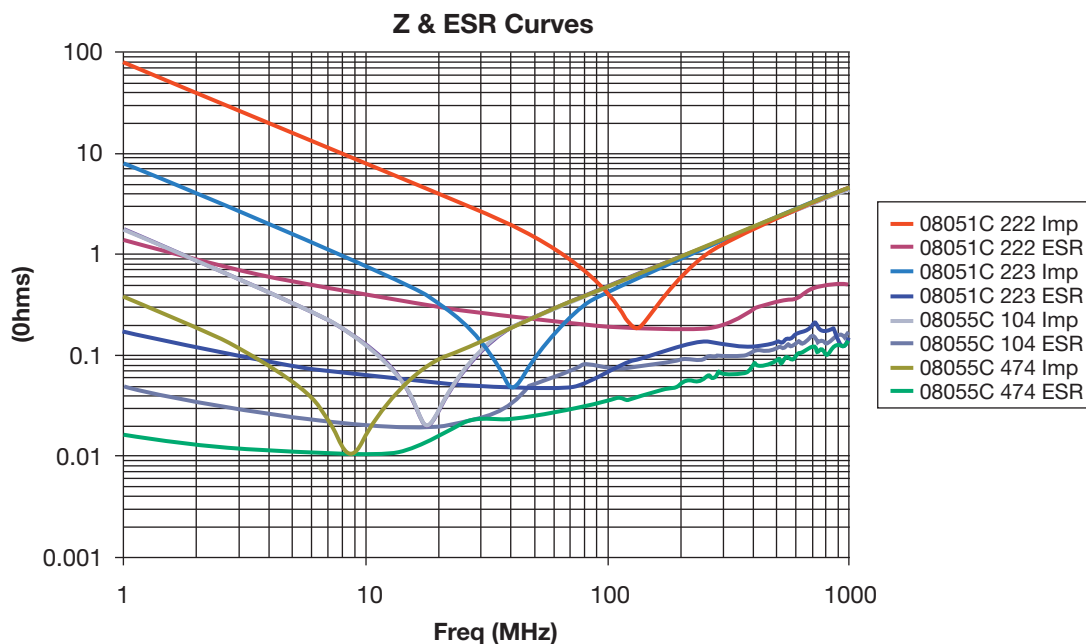

If required KYOCERA AVX will produce a data sheet for each part number with the following information:

- a) Impedance/ESR Frequency Sweep
- b) Capacitance Change with Temperature from -55°C to +125°C
- c) Capacitance Change with DC Voltage up to the rated voltage of the component
- d) Temperature Change with AC Current applied for higher capacitance values.



Engineering Module (EM) Range X7R BME MLCC for Non Flight Prototype

**Design Covering ESCC 3009041, NASA
S311-P838 and Mil 32535 Ranges**

Engineering Module (EM) Range X7R BME MLCC for Non Flight Prototype

Design Covering ESCC 3009041, NASA S311-P838 and Mil 32535 Ranges

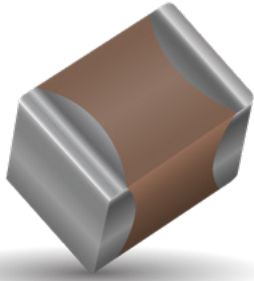

GENERAL DESCRIPTION

The EM series has been created to meet the growing demand for the space customers when a new design must be developed in a short time. KYOCERA AVX recommend using its -EM series of part numbers to meet this demand for nonflight/prototype designs.

Based upon its Space BME (3009041, NASA S311, Mil 32535 ranges) X7R & NP0 surface mount MLCCs the EM series use the same internal design and materials but without the final testing/screening (ESCC/QPL) for shorter lead times making it the ideal choice.

The EM series can be selected across the 3009041, NASA S311 and Mil 32535 ranges by selecting the matching dielectric, case size, voltage, capacitance value and capacitance tolerance.

BENEFITS

- EM Series allows customers to select non flight values from the ESCC 3009041/NASA S311-P838¹/Mil 32535 ranges for prototype design work.
- The EM range is finished with Sn/Pb and Flexitem® termination which protects against board flexure either during assembly or product lifetime.
- The EM range provides a high CV X7R range 16 – 100 volts, 2.2 nF – 22 uF and NP0 range 10 –100 Volts, 68 – 1500 pF.
- The EM range has shortened lead times to meet the customers' needs.
- With the EM range there is no Minimum Order Quantity.²

HOW TO ORDER

2220	5	C	106	K	A	R	6	-EM
Case Size	Voltage Code	Temp. Characteristics	Capacitance Value	Capacitance Tolerance	Reliability Level	Termination Finish	Packaging	Part Level
0402 0603 0805 1206 1210 1812 2220	4 V = 4 6.3V = 6 10V = Z 16V = Y 25V = 3 50V = 5 100V = 1	C = X7R A = NP0	10 nF = 103 100 nF = 104 1 uF = 105 4.7 uF = 475 10 uF = 106	± 5% = J ± 10% = K	Non Space = A	Sn/Pb with Flexitem® = R	Waffle = 6 Tape & Reel = 1	Engineering Module = EM

DIMENSIONS mm (inches)

Size	0402		0603		0805		1206		1210		1812		2220	
	Min.	Max.	Min.	Max.	Min.	Max.	Min.	Max.	Min.	Max.	Min.	Max.	Min.	Max.
(L) Length	0.90 (0.035)	1.15 (0.045)	1.45 (0.057)	1.75 (0.069)	1.80 (0.071)	2.20 (0.087)	3.00 (0.118)	3.40 (0.134)	3.00 (0.118)	3.40 (0.134)	4.20 (0.165)	4.80 (0.189)	5.3 (0.208)	6.1 (0.24)
(W) Width	0.41 (0.016)	0.61 (0.024)	0.65 (0.026)	0.95 (0.037)	1.05 (0.041)	1.45 (0.057)	1.40 (0.055)	1.80 (0.071)	2.30 (0.091)	2.70 (0.106)	3.00 (0.118)	3.40 (0.124)	4.60 (0.18)	5.41 (0.213)
(T) Thickness	0.61 Max. (0.024)		1.00 Max. (0.039)		1.52 Max. (0.060)		1.80 Max. (0.071)		2.80 Max. (0.110)		2.80 Max. (0.110)		2.80 Max. (0.110)	
(t) terminal	0.1 (0.004)	0.40 (0.015)	0.20 (0.008)	0.50 (0.020)	0.25 (0.010)	0.75 (0.030)	0.25 (0.010)	0.75 (0.030)	0.25 (0.010)	0.75 (0.030)	0.25 (0.010)	0.95 (0.037)	0.25 (0.009)	1.03 (0.041)

**Engineering Module (EM) Range X7R BME MLCC for
Non Flight Prototype
Design Covering ESCC 3009041, NASA S311-P838 and Mil 32535 Ranges**



PREFERRED SIZES ARE SHADED

Case Sizes		0402			0603			0805			1206			1210			1812			2220			
Code	Value	16/25V	50V	100V	16/25V	50V	100V	16/25V	50V	100V	16/25V	50V	100V	16/25V	50V	100V	16/25V	50V	100V	16/25V	50V	100V	
222	2.2 (nF)																						
272	2.7																						
332	3.3																						
392	3.9																						
472	4.7																						
562	5.6																						
682	6.8																						
822	8.2																						
103	10																						
123	12																						
153	15																						
183	18																						
223	22																						
273	27																						
333	33																						
393	39																						
473	47																						
563	56																						
683	68																						
823	82																						
104	100																						
124	120																						
154	150																						
184	180																						
224	220																						
274	270																						
334	330																						
394	390																						
474	470																						
564	560																						
684	680																						
824	820																						
105	1 (µF)																						
125	1.2																						
155	1.5																						
185	1.8																						
225	2.2																						
275	2.7																						
335	3.3																						
395	3.9																						
475	4.7																						
565	5.6																						
685	6.8																						
825	8.2																						
106	10																						
126	12																						
156	15																						
186	18																						
226	22																						

Note 1, NASA S311-P838 does not include 0402 and 2220 values currently.
Note 2, with the EM range there is no Minimum Order Quantity check with the production plant for confirmation.

**Engineering Module (EM) Range NP0 BME MLCC for
Non Flight Prototype
Design Covering Mil 32535 NP0 Ranges**



PREFERRED SIZES ARE SHADED

Case Sizes			M3253502					M3253503					M3253503				
			0402					0603					0805				
Code	Value	Cap Tol	4-10 V	16 V	25 V	50 V	100 V	4-10 V	16 V	25 V	50 V	100 V	4-10 V	16 V	25 V	50 V	100V
680	68 pF	F,G,J,K															
820	82 pF	F,G,J,K															
101	100 pF	F,G,J,K															
121	120 pF	F,G,J,K															
151	150 pF	F,G,J,K															
181	180 pF	F,G,J,K															
221	220 pF	F,G,J,K															
271	270 pF	F,G,J,K															
331	330 pF	F,G,J,K															
391	390 pF	F,G,J,K															
471	470 pF	F,G,J,K															
561	560 pF	F,G,J,K															
681	680 pF	F,G,J,K															
821	820 pF	F,G,J,K															
102	1000pF	F,G,J,K															
122	1200pF	F,G,J,K															
152	1500pF	F,G,J,K															
182	1800pF	F,G,J,K															
202	2000pF	F,G,J,K															
222	2200pF	F,G,J,K															
272	2700pF	F,G,J,K															
332	3300pF	F,G,J,K															
392	3900pF	F,G,J,K															
472	4700pF	F,G,J,K															



QPL ESCC 3009 and CECC Surface Mount MLCC, Type I & II

QPL ESCC 3009 and CECC Surface Mount MLCC, Type I & II

AVAILABLE TYPES

MLC CHIPS vs ESA ESCC & vs CECC 32101-002, 003 (established reliability) from 25V up to 500V.

AVAILABLE RELIABILITY LEVELS

ESA QUALIFIED		with or without LVT 1,2a,2b,3
CECC + 100% Burn in /168H + Thermal shock + 85/85 humidity test + on 40 samples per batch + DPA	T6	
CECC + 100% Burn in /168H + DPA	T5	
CECC + 100% Burn in /48H + DPA	T3	
CECC + DPA	T2	

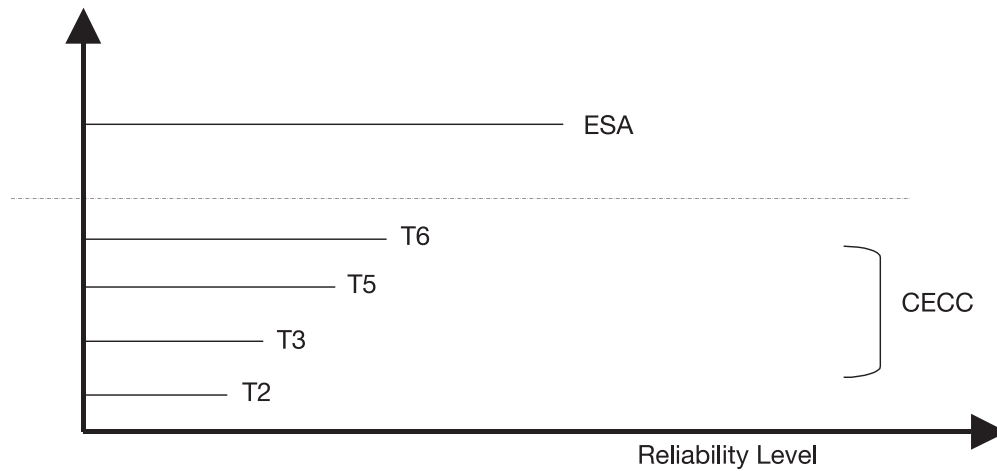

- ▶ Level T5 & T6: Reliability Level = MIL S
- ▶ Level T3: Reliability Level = MIL R

AVAILABLE RELIABILITY LEVELS SUMMARY/TYPES

Types	Products		Reliability Level	
			T6 to T2	ESA
MLC Chips	AN, AC & AD 12, 13, 14, 15, 20 (NP0, X7R)	CECC	X	
MLC Chips ESA Qualified/3009	A...C NP0 A...Z X7R A...G 2C1	ESA ESCC		X

RELEVANT STANDARDS

Type of Component	Reliability Level	
	T2 / T3 / T5 / T6	ESA Level
MLC Chips	CECC 32101-002 32101-003 32101-801	ESA ESCC 3009
	IEC 60384-21/22	

QPL ESCC 3009 and CECC Surface Mount MLCC, Type I & II

DIELECTRIC TYPES USED

Type I

► NP0 ► Code: C

Type II

► X7R ► Code: Z
► 2C1 ► Code: G

ELECTRICAL MEASUREMENT CONDITIONS FOR CECC CHIPS: T2 / T3 / T5 / T6

Type code		1 C	2 Z
Classification	IEC/CECC EIA DIN MIL	1B COG NP0 CG	2R1 X7R
Capacitance change With temperature & :	Ubias = 0 Ubias = UR	±30ppm/°C	± 15% N.A.
Typical ageing (%/dec.)		0	1.5
Reference temperature		22°C ±3°C	22°C ±3°C
Capacitance and D.F. measurement	Frequency Voltage	C ≤ 1000 pF F = 1MHz C > 1000 pF F = 1 kHz Um ≤ 5 Vrms	C ≤ 100 pF F = 1MHz C > 100 pF F = 1 kHz Um ≤ 0.3 Vrms ± 0.2
Dissipation Factor (DF)		C ≤ 50 pF DF < 1.5 (150/C + 7) · 10 ⁻⁴ C > 50 pF DF < 15 · 10 ⁻⁴	DF < 250 · 10 ⁻⁴
Insulation Resistance under UR / 1 mn		For C ≤ 10nF: Ri > 100 GΩ or For C > 10nF: Ri x Cr > 1000s	For C ≤ 10nF: Ri > 100 GΩ or For C > 10nF: Ri x Cr > 1000s
Proof voltage		For UR ≤ 100V : 2.5 x UR For UR > 100V : 1.5 UR + 100V	For UR ≤ 100V : 2.5 x UR For UR > 100V : 1.5 x UR + 100V

Note: ESA Chips are strictly measured vs ESA spec. 3009 + detail spec.

ELECTRICAL MEASUREMENT CONDITIONS FOR ESA CHIPS

Type code		1 C	2 Z G	
Classification	IEC/CECC EIA DIN MIL	1B COG NP0 CG	2R1 X7R	2C1 BX
Capacitance change With temperature & :	Ubias = 0 Ubias = UR	±30ppm/°C	± 20% *-60/+20%	± 20% -30/+20%
Typical ageing (%/dec.)		0	1.5	1.5
Reference temperature		22°C ±3°C	22°C ±3°C	22°C ±3°C
Capacitance and D.F. measurement	Frequency Voltage	C ≤ 1000 pF F = 1MHz C > 1000 pF F = 1 kHz Um ≤ 5 Vrms	C ≤ 100 pF F = 1MHz C > 100 pF F = 1 kHz Um ≤ 1 Vrms	
Dissipation Factor (DF)		C ≤ 50 pF DF < 1.5 (150/C + 7) · 10 ⁻⁴ C > 50 pF DF < 15 · 10 ⁻⁴	DF < 250 · 10 ⁻⁴	
Insulation Resistance under UR / 1 mn		Ri > 100 GΩ	For C ≤ 10nF: Ri > 100 GΩ or For C > 10nF: Ri x Cr > 1000s	
Proof voltage		For UR < 500V : 2.5 x UR	For UR < 500V : 2.5 x UR For UR = 500V : 2 x UR	

*Typical value for this dielectric class

Note: ESA Chips are strictly measured vs ESA spec. 3009 + detail spec.

QPL ESCC 3009 and CECC Surface Mount MLCC, Type I & II

RELIABILITY LEVELS DESCRIPTION

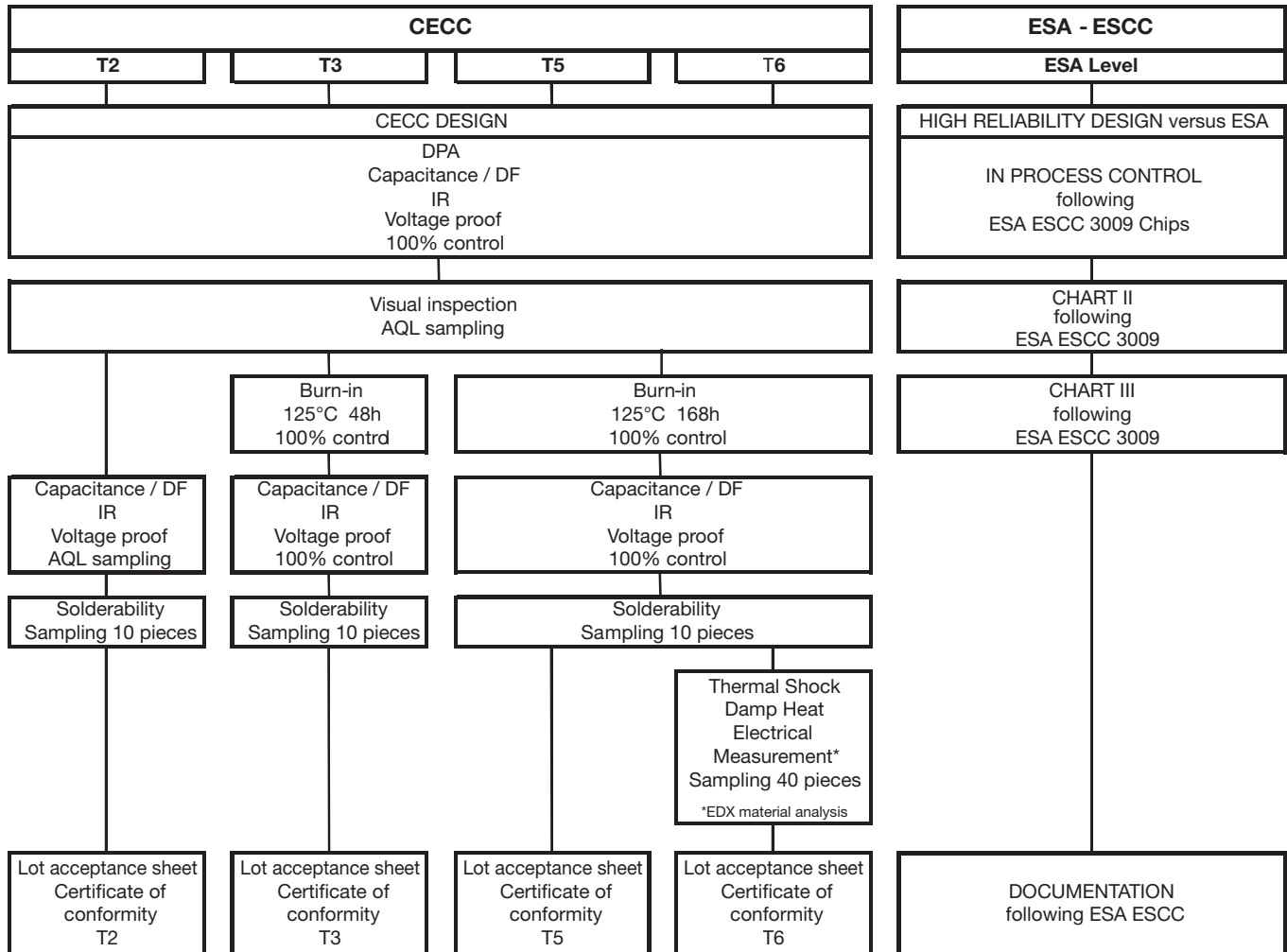

QPL ESCC 3009 and CECC Surface Mount MLCC, Type I & II

AVAILABLE TERMINATIONS

Summary

Type	CECC Level T2/T3/T5/T6	ESA Level	Remark
Ag - Pd - Pt	AC	A3..	-
Nickel Barrier + Tin Lead Finish ⁽¹⁾	AN	A6...	Preferred Version
Nickel Barrier + Tin Finish ⁽²⁾	AD		

⁽¹⁾ "No Pure Tin" terminations.

⁽²⁾ Lead Free terminations.

TERMINATION CODES FOR ESA MLC PARTS

Code	ESA Version	
e.g. A.12	Code	Termination
A312C...	03	Silver Palladium Platinum
A312G...		
A312Z...	10	X7R Dielectric + Silver Palladium Platinum
A612C...	06	ESA Preferred Termination Nickel Barrier + Tin Lead Finish
A612G...		
A612Z....	07	X7R Dielectric + ESA Preferred Termination Nickel Barrier + Tin Lead Finish

PACKAGING

- Plastic Tape – Minimum Order Quantity: 1000p for CECC and ESA products*
*Note for smaller quantities contact plant
- Waffle Pack – Anti-static material only ESA Products – Minimum Order Quantity: 50p for ESA products
- Vacuum Pack only CECC Products – Minimum Order Quantity: 1Kp for CECC products

MARKING

Chips:

CECC	T6/T5/T3/T2	On packaging label only - versus code
ESA Level		On packaging label only - versus ESA code

AVAILABLE CLIMATIC AND ELECTRIC TESTS

Test P/N	Test Description	Qty. of Parts	Average Lead Time
XX00--5028---	DPA versus EIA RS469	25/X + 25/Y	1 to 2 weeks
MX00--5056---	85/85 Humidity test / ESA 3009 / 5.2.2 85°C / 85% HR / 1.5Vdc / 240h	50	3 weeks
MX00--5059---	85/85 Humidity test / MIL STD 202 Method 103 40°C / 95 HR / 100Vdc / 240h	50	3 weeks
MX00--5060---	85°C/85% HR / 240h Humidity test	12	3 weeks
XX00--5080-00	100% burn in (same as "5079" but limited to 48H)	100%	1 week
XX00--5079-00	100% burn in versus ESA 3009 (168H / 2x Ur)	100%	3 weeks
XX00--5090-00	Halt test (accelerated burn-in 140°C / 3Ur)	100pc	4 weeks
XX00--5100-00	Life test 1000 or 2000H versus ESA 3009/9.10	100pc	7 or 14 weeks
XX00--5082-00	Solderability test (bath method vs. ESA or CECC)	20pc	2 weeks
XX00--5091-00	Electric test (Cr; DF; IR) 100%	100%	Tbd
XX00--5092-00	Rapid change of temperature (-55° to 125°C)	50pc	Tbd
XX00--5093-00	Climatic test sequence	50pc	Tbd
XX00--5094-00	Visual insp. Versus ESA or customer spec.	100%	Tbd

QPL ESCC 3009 and CECC Surface Mount MLCC, Type I & II

ESA QUALIFIED CHIPS TYPE I - NPO

Case Sizes		0805		1206		1210		1812		2220	
Cap Tolerance		1,2,5,10 %, +/- 0.5pf for C < 10pf									
ESA QPL		3009003..		3009022..		3009004..		3009005..		3009006..	
CODE		A_12C..		A_20C..		A_13C..		A_14C..		A_15C..	
Value	Code	50v	100v	50v	100v	50v	100v	50v	100v	50v	100v
4.7pf	4R7										
5.6pf	5R6										
6.8pf	6R8										
8.2pf	8R2										
10pf	100										
12pf	120										
15pf	150										
18pf	180										
22pf	220										
27pf	270										
33pf	330										
39pf	390										
47pf	470										
56pf	560										
68pf	680										
82pf	820										
100pf	101										
120pf	121										
150pf	151										
180pf	181										
220pf	221										
270pf	271										
330pf	331										
390pf	391										
470pf	471										
560pf	561										
680pf	681										
820pf	821										
1.0 nf	102										
1.2nf	122										
1.5nf	152										
1.8 nf	182										
2.2nf	222										
2.7nf	272										
3.3nf	332										
3.9nf	392										
4.7nf	472										
5.6nf	562										
6.8nf	682										
8.2nf	822										
10nf	103										
12nf	123										
15nf	153										
18nf	183										
22nf	223										
27 nf	273										
33 nf	333										

Available Terminations:

A3.. Silver Palladium Platinum (ESA variant 03) and

A6.. Nickel Barrier with Tin Lead Finish (ESA variant 06)

QPL ESCC 3009 and CECC Surface Mount MLCC, Type I & II

ESA QUALIFIED CHIPS TYPE II - 2C1

Case Sizes		0805			1206			1210			1812			2220		
Cap Tolerance		5, 10, 20 %														
ESA QPL		3009008..			3009023..			3009009..			3009010..			3009011..		
CODE		A_12G..			A_20G..			A_13G..			A_14G..			A_15G..		
Value	Code	25 v	50v	100v	25v	50v	100v	25v	50v	100v	25v	50v	100v	25v	50v	100v
820 pf	821															
1.0nf	102															
1.2nf	122															
1.5nf	152															
1.8 nf	182															
2.2nf	222															
2.2nf	222															
2.7nf	272															
3.3nf	332															
3.9nf	392															
4.7nf	472															
5.6nf	562															
6.8nf	682															
8.2nf	822															
10nf	103															
12nf	123															
15nf	153															
18nf	183															
22nf	223															
27nf	273															
33nf	333															
39nf	393															
47nf	473															
56nf	563															
68nf	683															
82nf	823															
100nf	104															
120nf	124															
150nf	154															
180nf	184															
220nf	224															
270nf	274															
330nf	334															
390nf	394															
470nf	474															
560nf	564															
680nf	684															
820nf	824															
1uf	105															
1.2uf	125															
1.5uf	155															
1.8uf	185															
2.2uf	225															
2.7uf	275															
3.3uf	335															
3.9uf	395															
4.7uf	475															
5.6uf	565															
6.8uf	685															
8.2uf	825															
10uf	106															
22 uf	226															

Available Terminations:

- A3.. Silver Palladium Platinum (ESA variant 03) and
- A6.. Nickel Barrier with Tin Lead Finish (ESA variant 06)

QPL ESCC 3009 and CECC Surface Mount MLCC, Type I & II



ESA QUALIFIED CHIPS TYPE II - X7R ESA VARIANT 07

Case Sizes		0805				1206					1210					1812					2220									
Cap Tolerance		5, 10, 20 %																												
ESA QPL		3009008..				3009023..					3009009..					3009010..					3009011..									
CODE		A_12Z..				A_20Z..					A_13Z..					A_14Z..					A_15Z..									
Value	Code	25v	50v	100v	200v	25v	50v	100v	200v	400v	25v	50v	100v	200v	400v	25v	50v	100v	200v	400v	25v	50v	100v	200v	400v	25v	50v	100v	200v	400v
270 pf	271																													
330 pf	331																													
390 pf	391																													
470 pf	471																													
560 pf	561																													
680 pf	681																													
820 pf	821																													
1.0 nf	102																													
1.2nf	122																													
1.5nf	152																													
1.8 nf	182																													
2.2nf	222																													
2.7nf	272																													
3.3nf	332																													
3.9nf	392																													
4.7nf	472																													
5.6nf	562																													
6.8nf	682																													
8.2nf	822																													
10nf	103																													
12nf	123																													
15nf	153																													
18nf	183																													
22nf	223																													
27nf	273																													
33nf	333																													
39nf	393																													
47nf	473																													
56nf	563																													
68nf	683																													
82nf	823																													
100nf	104																													
120nf	124																													
150nf	154																													
180nf	184																													
220nf	224																													
270nf	274																													
330nf	334																													
390nf	394																													
470nf	474																													
560nf	564																													
680nf	684																													
820nf	824																													
1uf	105																													
1.2uf	125																													
1.5uf	155																													
1.8uf	185																													
2.2uf	225																													

Key Supplied "in accordance with "

QPL ESCC 3009 and CECC Surface Mount MLCC, Type I & II

CECC CHIPS TYPE I – NP0 (AVAILABLE RELIABILITY LEVEL: T6 TO T2) CECC UPGRADED
IEC 60384-21/22, CECC 32100-32101/801

Case Sizes		0805			1206				1210				1812				2220			
Cap Tolerance		1,2,5,10 %, +/- 0.5pf for C < 10pf																		
CODE		A_12C..			A_20C..				A_13C..				A_14C..				A_15C..			
Value	Code	25/50v	100v	200v	25/50v	100v	200v	500v	25/50v	100v	200v	500v	25/50v	100v	200v	500v	25/50v	100v	200v	500v
4.7pf	4R7																			
5.6pf	5R6																			
6.8pf	6R8																			
8.2pf	8R2																			
10pf	100																			
12pf	120																			
15pf	150																			
18pf	180																			
22pf	220																			
27pf	270																			
33pf	330																			
39pf	390																			
47pf	470																			
56pf	560																			
68pf	680																			
82pf	820																			
100pf	101																			
120pf	121																			
150pf	151																			
180pf	181																			
220pf	221																			
270pf	271																			
330pf	331																			
390pf	391																			
470pf	471																			
560pf	561																			
680pf	681																			
820pf	821																			
1.0 nf	102																			
1.2nf	122																			
1.5nf	152																			
1.8 nf	182																			
2.2nf	222																			
2.7nf	272																			
3.3nf	332																			
3.9nf	392																			
4.7nf	472																			
5.6nf	562																			
6.8nf	682																			
8.2nf	822																			
10nf	103																			
12nf	123																			
15nf	153																			
18nf	183																			
22nf	223																			
27 nf	273																			
33 nf	333																			
39 nf	393																			

Note: 3 terminations available: Ag Pd Pt ▶ AC, Nickel Barrier with Tin Lead finish ▶ AN, Nickel Barrier with Tin finish ▶ AD
Size 2225 available on request

QPL ESCC 3009 and CECC Surface Mount MLCC, Type I & II



CECC CHIPS TYPE II – X7R (AVAILABLE RELIABILITY LEVEL: T6 TO T2) CECC UPGRADED
IEC 60384-21/22, CECC 32100-32101/801

Case Sizes		0805			1206					1210					1812					2220					
Cap Tolerance		5, 10, 20 %																							
CODE		A_12Z..			A_20Z..					A_13Z..					A_14Z..					A_15Z..					
Value	Code	25/50v	100v	200v	25v	50v	100v	200v	500v	25v	50v	100v	200v	500v	25v	50v	100v	200v	500v	25v	50v	100v	200v	500v	
330 pf	331																								
390 pf	391																								
470 pf	471																								
560 pf	561																								
680 pf	681																								
820 pf	821																								
1000 pf	102																								
1.2nf	122																								
1.5nf	152																								
1.8 nf	182																								
2.2nf	222																								
2.7nf	272																								
3.3nf	332																								
3.9nf	392																								
4.7nf	472																								
5.6nf	562																								
6.8nf	682																								
8.2nf	822																								
10nf	103																								
12nf	123																								
15nf	153																								
18nf	183																								
22nf	223																								
27nf	273																								
33nf	333																								
39nf	393																								
47nf	473																								
56nf	563																								
68nf	683																								
82nf	823																								
100nf	104																								
120nf	124																								
150nf	154																								
180nf	184																								
220nf	224																								
270nf	274																								
330nf	334																								
390nf	394																								
470nf	474																								
560nf	564																								
680nf	684																								
820nf	824																								
1uf	105																								
1.2uf	125																								
1.5uf	155																								
1.8uf	185																								
2.2uf	225																								

Note: 3 terminations available: Ag Pd Pt ► AC, Nickel Barrier with Tin Lead finish ► AN, Nickel Barrier with Tin finish ► AD
Size 2225 available on request

QPL ESCC 3009 and CECC Surface Mount MLCC, Type I & II

DIMENSIONS

I - Chips T2/T3/T5/T6 (vs CECC) AN... AC... & AD...

Size	mm (inches)		
	L	W	t max.
0805	2.0 ± 0.3 (0.079 ± 0.012)	1.25 ± 0.3 (0.049 ± 0.012)	1.3 (0.051)
1206	3.2 ± 0.3 (0.126 ± 0.012)	1.6 ± 0.3 (0.063 ± 0.012)	1.6 (0.063)
1210	3.2 ± 0.3 (0.126 ± 0.012)	2.5 ± 0.3 (0.098 ± 0.012)	1.8 (0.071)
1812	4.5 ± 0.3 (0.177 ± 0.012)	3.2 ± 0.3 (0.126 ± 0.012)	1.8 (0.071)
2220	5.7 ± 0.4 (0.224 ± 0.016)	5.0 ± 0.4 (0.197 ± 0.016)	1.8 (0.071)

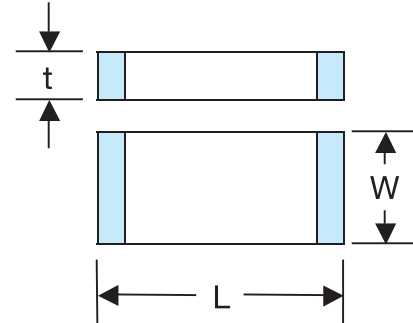

II - ESA Level 3009 A3... & A6...

Size	mm (inches)						
	L		W		Thickness max. (t)		
	min.	max.	min.	max.	NP0 Class	2C1 Class	X7R Class
0805	1.7 (0.067)	2.3 (0.091)	1.05 (0.041)	1.45 (0.057)	1.8(0.071)	1.8(0.071)	1.8(0.071)
1206	2.8 (0.110)	3.6 (0.142)	1.3 (0.051)	1.9(0.075)	2.3(0.091)	2.3(0.091)	2.3(0.091)
1210	2.8 (0.110)	3.6 (0.142)	2.2 (0.087)	2.8(0.110)	2.3(0.091)	2.3(0.091)	2.3(0.091)
1812	4.0 (0.157)	5.0 (0.197)	2.8 (0.110)	3.6(0.142)	2.8(0.110)	2.8(0.110)	2.8(0.110)
2220	5.2 (0.205)	6.2 (0.244)	4.5 (0.177)	5.5(0.217)	2.8(0.110)	2.8(0.110)	2.8(0.110)

Part thickness manufactured "according to ESA" exceed above limits.

QPL ESCC 3009 and CECC Surface Mount MLCC, Type I & II

HOW TO ORDER ESA NP0 WITH 3009 SPEC

3009	003	06	1002	J	C
Spec 3009	Component Variant 003 = 0805 022 = 1206 004 = 1210 005 = 1812 006 = 2220	Term Type 03 = Ag Pd Pt 06 = Ni/SnPb	Capacitance Code 3 significant digits + number of zeros e.g. 1002 = 10nF 1001 = 1nF	Capacitance Tolerance F = 1% G = 2% J = 5% K = 10%	Voltage C = 50V E = 100V

HOW TO ORDER ESA 2C1 & X7R WITH 3009 SPEC

3009	008	07	1003	K	C
Spec 3009	Component Variant 008 = 0805 023 = 1206 009 = 1210 010 = 1812 011 = 2220	Term Type 03 = Ag Pd Pt 06 = Ni/SnPb 07 = Ni/SnPb (X7R)	Capacitance Code 2 significant digits + number of zeros e.g. 103 = 10nF 105 = 1µF	Capacitance Tolerance J = 5% K = 10% M = 20%	Voltage A = 25 C = 50V E = 100V G = 200V K = 400V

QPL ESCC 3009 and CECC Surface Mount MLCC, Type I & II

HOW TO ORDER ESA MLCC

A6	14	C	E	0222	K	NC
Termination	Size	Class	Voltage	Capacitance	Tolerance	Suffix
A3 = AgPdPt Terminations A6 = Nickel Barrier Terminations with Tin Lead Finish	12 = 0805 13 = 1210 14 = 1812 15 = 2220 20 = 1206 43 = 2225	Z = X7R C = NP0 G = 2C1	C = 25V D = 50/63V E = 100V F = 200V G = 250V I = 400V J = 500V	Capacitance expressed by 2 significant figures 7th digit: 0 (zero) 8th and 9th digits: the 2 significant figures of the capacitance value. 10th digit: - for values > 10 pF and > 990 μF: the number of ZEROS to be added to the capacitance value - for values > 1 pF and > 9.9 pF: the figure 9 signifying that the capacitance value is to be multiplied by 0.1 - for values < 1 pF: the figure 8 signifying that the capacitance value is to be multiplied by 0.01. Examples: 1000 pF: 0102 8.2 pF: 0829 0.47 pF: 0478	C < 10 pF Code ± 0.5pF D C > 10 pF Code ± 1% F ± 2% G ± 5% J ± 10% K ± 20% M	suffix / ESCC NC = See Note 1 2J = See Note 2 NB = See Note 3

Capacitance expressed by 3 significant figures **7th, 8th and 9th digits:** the 3 significant figures of the capacitance value
10th digit:
- for values > 100 pF and > 990 μF: the number of ZEROS to be added to the capacitance value
- for values > 10 pF and < 100 pF: the figure 9 signifying that the capacitance value is to be multiplied by 0.1
- for values > 1 pF and < 10 pF: the figure 8 signifying that the capacitance value is to be multiplied by 0.01.
Examples: 196 pF: 1960
47.2 pF: 4729
8.28 pF: 8288

Not RoHS Compliant



LEAD-FREE
LEAD-FREE COMPATIBLE COMPONENT

For RoHS compliant products, please select correct termination style.

Note 1: NC suffix is for testing level of ESCC 3009 Issue 2 or C testing level of ESCC 3009 Issue 1, waffle-pack packing.
Note 2: 2J suffix is for testing level of ESCC 3009 Issue 2 or C testing level of ESCC 3009 Issue 1, tape & reel packing.
Note 3: NB suffix is for serialised B testing level of ESCC 3009 issue 1, waffle-pack packing.

HOW TO ORDER CECC MLCC

AN	14	C	E	0222	K	T6
Termination	Size	Class	Voltage	Capacitance	Tolerance	CECC Suffix
AC = AgPdPt Terminations AN = Nickel Barrier Terminations with Tin Lead Finish AD = Nickel Barrier Terminations with Tin Finish	12 = 0805 13 = 1210 14 = 1812 15 = 2220 20 = 1206 43 = 2225	Z = X7R C = NP0	C = 25V D = 50/63V E = 100V F = 200V G = 250V I = 400V J = 500V	Capacitance expressed by 2 significant figures 7th digit: 0 (zero) 8th and 9th digits: the 2 significant figures of the capacitance value. 10th digit: - for values > 10 pF and > 990 μF: the number of ZEROS to be added to the capacitance value - for values > 1 pF and > 9.9 pF: the figure 9 signifying that the capacitance value is to be multiplied by 0.1 - for values < 1 pF: the figure 8 signifying that the capacitance value is to be multiplied by 0.01. Examples: 1000 pF: 0102 8.2 pF: 0829 0.47 pF: 0478	C < 10 pF Code ± 0.5pF D C > 10 pF Code ± 1% F ± 2% G ± 5% J ± 10% K ± 20% M	Burn-in 100% 168H +TS +HR T6 Burn-in 100% 168H T5 Burn-in 100% 48H T3 No Burn-in T2 T5 + Tape 2K T3 + Tape 2L T2 + Tape 2Y T6 + Tape 24 T5 + Waffle Pack 9Y

Capacitance expressed by 3 significant figures **7th, 8th and 9th digits:** the 3 significant figures of the capacitance value
10th digit:
- for values > 100 pF and > 990 μF: the number of ZEROS to be added to the capacitance value
- for values > 10 pF and < 100 pF: the figure 9 signifying that the capacitance value is to be multiplied by 0.1
- for values > 1 pF and < 10 pF: the figure 8 signifying that the capacitance value is to be multiplied by 0.01.
Examples: 196 pF: 1960
47.2 pF: 4729
8.28 pF: 8288

Not RoHS Compliant



LEAD-FREE
LEAD-FREE COMPATIBLE COMPONENT

For RoHS compliant products, please select correct termination style.



ESCC Qualified SMPS Capacitors

ESCC Qualified SMPS Capacitors

High Voltage Chip/Leaded Capacitors

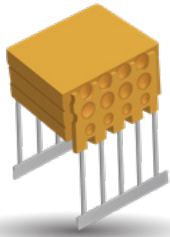

HIGH VOLTAGE CHIP CAPACITORS

Capacitors, Fixed, Chip, Ceramic Dielectric, Type II, High Voltage, Based on Styles 1812 and 1825 for use in ESCC space programs, according to ESCC Generic Specification 3009 and associated Detail Specification 3009/034 as recommended by the Space Components Coordination Group. (ranges in table below)

Note: Variants 01 to 12: metallized pads suitable for Hybrid circuits, glue or wire bonding Variants 13 to 24: finished with Sn coating suitable for soldering Variants 13 - 24 are tested "in accordance with"

HOW TO ORDER

Parts should be ordered using the ESCC variant number as follows:

<u>3009034</u>	<u>XX</u>	<u>XXX</u>
Detail Spec Number	Type Variant (per table)	Capacitance Code
		The first two digits represent significant figures and the third digit specifies the number of zeros to follow; i.e. 102 = 1000pF 103 = 10000pF
Eg 300903401223		
For LVT testing, please refer to 3009 LVT Spec		

Size	Variant	Rated Voltage (kV)	Tolerance (%)	Capacitance Code (E12)	
1812	01 / 13	1.0	±10	392 - 223	
	02 / 14		±20		
	03 / 15	2.0	±10	152 - 182	
	04 / 16		±20		
	05 / 17		±10		
1825	06 / 18	3.0	±20	821 - 102	
	07 / 19		±10		
	08 / 20	1.0	±20	273 - 563	
	09 / 21		±10		
	10 / 22		±20		
	1825	11 / 23	2.0	±10	222 - 682
		12 / 24		±20	
		3.0	±10	821 - 392	

HIGH VOLTAGE LEADED CAPACITORS

Capacitors, Fixed, Ceramic Dielectric, Type II, High Voltage, 1.0 to 5.0 kV, Based on Case Styles VR, CV and CH for use in ESCC space programs, according to ESCC Generic Specification 3001 and associated Detail Specification 3001/034 as recommended by the Space Components Coordination Group. (ranges in table)

Note 1: Lead Types

- a - Leaded Radial (epoxy coated)
- b - Leaded Radial (Polyurethane Varnish)
- c - Straight Dual in Line
- d - L Dual in Line

Note 2: Tolerances of ±10% and ±20% are available

Note 3: KYOCERA AVX does not recommend or advise the use of adhesives to secure these components to the PCB or any other component / device

Case Size	Variant	Lead Type	Capacitance Code (E12)				
			1.0kV	2.0kV	3.0kV	4.0kV	5.0kV
VR30S	01	a	392 - 203	152 - 182	821 - 102		
VR30	02	a	273 - 563	222 - 682	821 - 392		
VR40	03	a	473 - 124	822 - 153	472 - 103	182 - 222	
VR50	04	a	154 - 274	183 - 333	123 - 183	562 - 822	332 - 392
VR66	05	a	224 - 564	393 - 823	223 - 393	103 - 153	682 - 103
VR84	06	a	684 - 105	473 - 154	473 - 683	183 - 393	123 - 183
VR90	07	a	125 - 275	184 - 334	823 - 184	473 - 124	223 - 563
CV41	08	b	473 - 124	822 - 153	472 - 103	182 - 222	
CH41	09	c	473 - 124	822 - 153	472 - 103	182 - 222	
CH41	10	d	473 - 124	822 - 153	472 - 103	182 - 222	
CV51	11	b	154 - 274	183 - 333	123 - 183	562 - 822	332 - 392
CH51	12	c	154 - 274	183 - 333	123 - 183	562 - 822	332 - 392
CH51	13	d	154 - 274	183 - 333	123 - 183	562 - 822	332 - 392
CV61	14	b	224 - 564	393 - 823	223 - 393	103 - 153	682 - 103
CH61	15	c	224 - 564	393 - 823	223 - 393	103 - 153	682 - 103
CH61	16	d	224 - 564	393 - 823	223 - 393	103 - 153	682 - 103
CV76	17	b	684 - 105	473 - 154	473 - 683	183 - 393	123 - 183
CH76	18	c	684 - 105	473 - 154	473 - 683	183 - 393	123 - 183
CH76	19	d	684 - 105	473 - 154	473 - 683	183 - 393	123 - 183
CV91	20	b	125 - 275	184 - 334	823 - 184	473 - 124	223 - 563
CH91	21	c	125 - 275	184 - 334	823 - 184	473 - 124	223 - 563
CH91	22	d	125 - 275	184 - 334	823 - 184	473 - 124	223 - 563

HOW TO ORDER

Parts should be ordered using the ESCC variant number as follows:

<u>3001034</u>	<u>XX</u>	<u>XXX</u>	<u>K</u>	<u>X</u>
Detail Spec Number	Type Variant (per table above)	Capacitance Code	Capacitance Tolerance	Voltage
		The first two digits represent significant figures and the third digit specifies the number of zeros to follow; i.e. 102 = 1000pF 103 = 10000pF	K = 10% M = 20%	M = 1kV P = 2kV R = 3kV S = 4kV Z = 5kV
Eg 300103412274M				

Eg 300103412274M

LAT and Serialization testing can still be performed. Contact plant for further details

For LVT testing, please refer to 3001 LVT spec

ESCC Qualified SMPS Capacitors

High Capacitance

HIGH CAPACITANCE LEADED CAPACITORS

Capacitors, Fixed, Ceramic Dielectric, Type II, High Capacitance, Based on Case Styles BR, CV and CH for use in ESCC space programs, according to ESCC Generic Specification 3001 and associated Detail Specification 3001/030 as recommended by the Space Components Coordination Group. (see ranges in table below)

Note 1: Lead Types

- a - Leaded Radial (epoxy coated)
- b - Leaded Radial (Polyurethane Varnish)
- c - Straight Dual in Line
- d - L Dual in Line

Note 2: Tolerances of ±10% and ±20% are available

Case Size	Variant	Figure	Capacitance Code (E12)			
			50V	100V	200V	500V
BR40	01	a	185 - 335	125 - 395	334 - 564	124 - 224
BR50	02	a	395 - 565	225 - 395	684 - 105	274 - 394
BR66	03	a	685 - 106	475 - 825	105 - 225	474 - 105
BR72	04	a	126 - 186	825 - 156	225 - 335	824 - 155
BR84	05	a	126 - 186	825 - 156	225 - 335	824 - 155
CV41	06	b	185 - 335	125 - 275	334 - 564	124 - 224
CH41	07	c	185 - 335	125 - 275	334 - 564	124 - 224
CH41	08	d	185 - 335	125 - 275	334 - 564	124 - 224
CH42	09	c	395 - 685	335 - 565	684 - 125	274 - 474
CH42	10	d	395 - 685	335 - 565	684 - 125	274 - 474
CH43	11	c	825 - 106	685 - 825	155 - 185	564 - 684
CH43	12	d	825 - 106	685 - 825	155 - 185	564 - 684
CH44	13	c	126	106	225	824 - 105
CH44	14	d	126	106	225	824 - 105
CV51	15	b	395 - 565	225 - 395	684 - 105	274 - 394
CH51	16	c	395 - 565	225 - 395	684 - 105	274 - 394
CH51	17	d	395 - 565	225 - 395	684 - 105	274 - 394
CH52	18	c	685 - 106	475 - 825	125 - 225	474 - 824
CH52	19	d	685 - 106	475 - 825	125 - 225	474 - 824
CH53	20	c	126 - 156	106 - 126	275 - 335	105 - 125
CH53	21	d	126 - 156	106 - 126	275 - 335	105 - 125
CH54	22	c	186 - 226	156	395	155
CH54	23	d	186 - 226	156	395	155
CV61	24	b	685 - 106	475 - 825	105 - 225	474 - 105
CH61	25	c	685 - 106	475 - 825	105 - 225	474 - 105
CH61	26	d	685 - 106	475 - 825	105 - 225	474 - 105
CH62	27	c	126 - 226	106 - 156	275 - 475	105 - 185
CH62	28	d	126 - 226	106 - 156	275 - 475	105 - 185
CH63	29	c	276 - 336	186 - 226	565 - 685	225 - 275
CH63	30	d	276 - 336	186 - 226	565 - 685	225 - 275
CH64	31	c	396	276 - 336	825 - 106	335
CH64	32	d	396	276 - 336	825 - 106	335
CV71	33	b	126 - 186	825 - 156	225 - 335	824 - 155
CH71	34	c	126 - 186	825 - 156	225 - 335	824 - 155
CH71	35	d	126 - 186	825 - 156	225 - 335	824 - 155
CH72	36	c	226 - 396	186 - 276	395 - 685	185 - 335
CH72	37	d	226 - 396	186 - 276	395 - 685	185 - 335

Case Size	Variant	Figure	Capacitance Code (E12)			
			50V	100V	200V	500V
CH73	38	c	476 - 566	336 - 396	825 - 106	395 - 475
CH73	39	d	476 - 566	336 - 396	825 - 106	395 - 475
CH74	40	c	686	476	126	565
CH74	41	d	686	476	126	565
CV76	42	b	126 - 186	825 - 156	225 - 335	824 - 155
CH76	43	c	126 - 186	825 - 156	225 - 335	824 - 155
CH76	44	d	126 - 186	825 - 156	225 - 335	824 - 155
CH77	45	c	226 - 396	186 - 276	395 - 685	185 - 335
CH77	46	d	226 - 396	186 - 276	395 - 685	185 - 335
CH78	47	c	476 - 566	336 - 396	825 - 106	395 - 475
CH78	48	d	476 - 566	336 - 396	825 - 106	395 - 475
CH79	49	c	686	476	126	565
CH79	50	d	686	476	126	565
CH81	51	c	156 - 226	126 - 186	225 - 395	824 - 155
CH81	52	d	156 - 226	126 - 186	225 - 395	824 - 155
CH82	53	c	276 - 476	226 - 396	475 - 825	
CH82	54	d	276 - 476	226 - 396	475 - 825	
CH83	55	c	566 - 686	476 - 566	106 - 126	
CH83	56	d	566 - 686	476 - 566	106 - 126	
CH84	57	c	826	686	156	
CH84	58	d	826	686	156	
CH86	59	c	226 - 336	156 - 276	395 - 685	155 - 225
CH86	60	d	226 - 336	156 - 276	395 - 685	155 - 225
CH87	61	c	396 - 686	336 - 566	825 - 156	
CH87	62	d	396 - 686	336 - 566	825 - 156	
CH88	63	c	826 - 107	686 - 826	186 - 226	
CH88	64	d	826 - 107	686 - 826	186 - 226	
CH89	65	c	127	107	276	
CH89	66	d	127	107	276	
CH91	67	c	396 - 476	336 - 396	825 - 106	
CH91	68	d	396 - 476	336 - 396	825 - 106	
CH92	69	c	566 - 107	476 - 826	126 - 226	
CH92	70	d	566 - 107	476 - 826	126 - 226	
CH93	71	c	127 - 157	107 - 127	276 - 336	
CH93	72	d	127 - 157	107 - 127	276 - 336	
CH94	73	c	187	157	396	
CH94	74	d	187	157	396	

HOW TO ORDER

Parts should be ordered using the ESCC variant number as follows:

3001030

Detail Spec Number

XX

Type Variant (per table above)

XXX

Capacitance Code

The first two digits represent significant figures and the third digit specifies the number of zeros to follow; i.e.

102 = 1000pF

103 = 10000pF

K

Capacitance Tolerance
K = 10%
M = 20%

X

Voltage
C = 50V
E = 100V
G = 200V
L = 500V

EG 300103018106KC

LAT and Serialization testing can still be preformed.

Contact plant for further details

Note 3: KYOCERA AVX does not recommend or advise the use of adhesives to secure these components to the PCB or any other component / device



SMPS LVT Details & Physical Dimensions

SMPS LVT Details & Physical Dimensions

LVT 3001 TEST DETAIL

L V T Group	LVT 3001 Test Detail	Min No. Pcs Tested
1A	Rapid Change of Temperature, Steady state humidity testing, external visual inspection	20
1B	Rapid Change of Temperature, Vibration, Shock, External visual inspection	3
2A	Extended Life testing, 1000 hrs	10
2B	Capacitance Temperature Change	3
3	Solderability, resistance Soldering, Permacne of marking	3

ESCC DETAIL SPECIFICATION NO. 3009/034 PHYSICAL DIMENSIONS

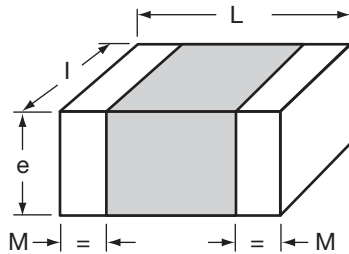

Millimeters (Inches)

Symbol	Variants 01 to 06		Variants 07 to 12	
	Min.	Max.	Min.	Max.
L	4.20 (0.165)	5.00 (0.197)	4.20 (0.165)	5.00 (0.197)
l	2.80 (0.110)	3.60 (0.142)	5.67 (0.223)	6.67 (0.263)
e	-	3.00 (0.118)	-	3.30 (0.130)
M	0.25 (0.010)	0.75 (0.030)	0.25 (0.010)	0.75 (0.030)

ESCC DETAIL SPECIFICATION NO. 3001/034 PHYSICAL DIMENSIONS – VR STYLE

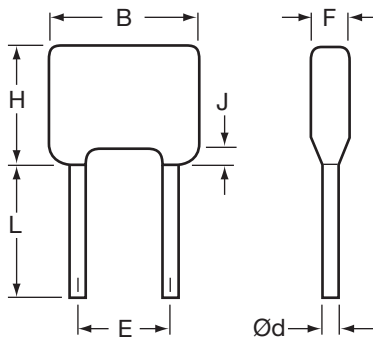

Millimeters (Inches)

Variant	Case Size	B	Ød		E		F	H	J	L
		Max.	Min.	Max.	Min.	Max.	Max.	Max.	Max.	Min.
01	VR30S	7.62 (0.300)	0.46 (0.018)	0.56 (0.022)	4.58 (0.180)	5.58 (0.220)	5.00 (0.197)	4.60 (0.181)	1.50 (0.059)	31.7 (1.248)
02	VR30	7.62 (0.300)	0.46 (0.018)	0.56 (0.022)	4.58 (0.180)	5.58 (0.220)	5.00 (0.197)	9.62 (0.379)	1.50 (0.059)	31.7 (1.248)
03	VR40	10.16 (0.400)	0.46 (0.018)	0.56 (0.022)	4.58 (0.180)	5.58 (0.220)	5.00 (0.197)	11.7 (0.461)	1.50 (0.059)	31.7 (1.248)
04	VR50	12.7 (0.500)	0.59 (0.023)	0.69 (0.027)	9.66 (0.380)	10.66 (0.420)	5.10 (0.201)	14.2 (0.559)	1.50 (0.059)	31.7 (1.248)
05	VR66	17.5 (0.689)	0.86 (0.034)	0.96 (0.038)	14.2 (0.559)	15.2 (0.598)	6.40 (0.252)	16.5 (0.650)	1.50 (0.059)	31.7 (1.248)
06	VR84	23.62 (0.930)	0.86 (0.034)	0.96 (0.038)	20.4 (0.803)	22.0 (0.866)	6.40 (0.252)	19.78 (0.779)	1.50 (0.059)	31.7 (1.248)
07	VR90	23.5 (0.925)	0.86 (0.034)	0.96 (0.038)	20.4 (0.803)	22.0 (0.866)	6.40 (0.252)	42.0 (1.654)	1.50 (0.059)	31.7 (1.248)

ESCC DETAIL SPECIFICATION NO. 3001/034 PHYSICAL DIMENSIONS – CV STYLE

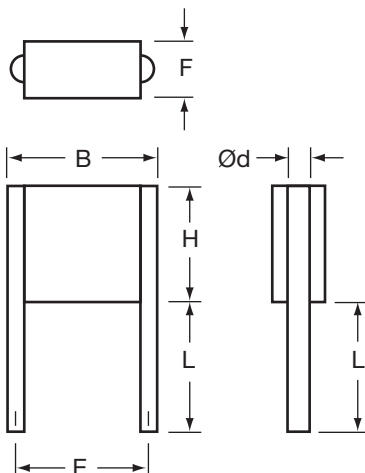

Millimeters (Inches)

Variant	Case Size	B	Ød		E		F	H	J	L
		Max.	Min.	Max.	Min.	Max.	Max.	Max.	Max.	Min.
01	VR30S	7.62 (0.300)	0.46 (0.018)	0.56 (0.022)	4.58 (0.180)	5.58 (0.220)	5.00 (0.197)	4.60 (0.181)	1.50 (0.059)	31.7 (1.248)
02	VR30	7.62 (0.300)	0.46 (0.018)	0.56 (0.022)	4.58 (0.180)	5.58 (0.220)	5.00 (0.197)	9.62 (0.379)	1.50 (0.059)	31.7 (1.248)
03	VR40	10.16 (0.400)	0.46 (0.018)	0.56 (0.022)	4.58 (0.180)	5.58 (0.220)	5.00 (0.197)	11.7 (0.461)	1.50 (0.059)	31.7 (1.248)
04	VR50	12.7 (0.500)	0.59 (0.023)	0.69 (0.027)	9.66 (0.380)	10.66 (0.420)	5.10 (0.201)	14.2 (0.559)	1.50 (0.059)	31.7 (1.248)
05	VR66	17.5 (0.689)	0.86 (0.034)	0.96 (0.038)	14.2 (0.559)	15.2 (0.598)	6.40 (0.252)	16.5 (0.650)	1.50 (0.059)	31.7 (1.248)

SMPS LVT Details & Physical Dimensions

ESCC DETAIL SPECIFICATION NO. 3001/034 PHYSICAL DIMENSIONS – CH STYLE, D.I.L.

Millimeters (Inches)

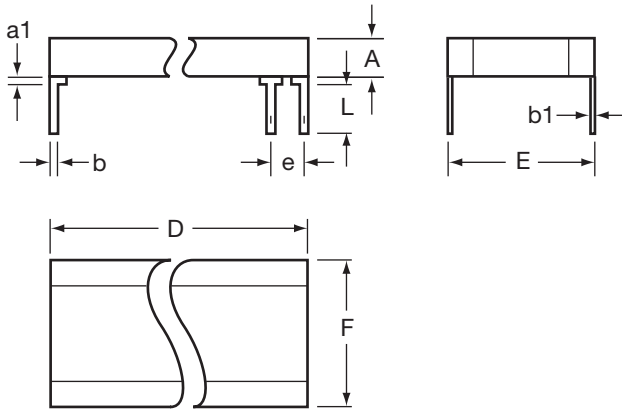

Symbol	Min.	Max.	Notes
a1	-	2.00 (0.079)	1
b	0.45 (0.018)	0.55 (0.022)	1
b1	0.204 (0.008)	0.304 (0.012)	1
e	2.49 (0.098)	2.59 (0.102)	2
L	12.0 (0.472)	14.0 (0.551)	1

Notes: 1 – All leads
2 – Each space

Variant	Case Size	A	D	E		F
		Max.	Max.	Min.	Max.	Max.
07	CH41	3.80 (0.150)	8.70 (0.343)	7.70 (0.303)	8.70 (0.343)	9.20 (0.362)
09	CH42	7.40 (0.291)	8.70 (0.343)	7.70 (0.303)	8.70 (0.343)	9.20 (0.362)
11	CH43	11.1 (0.437)	8.70 (0.343)	7.70 (0.303)	8.70 (0.343)	9.20 (0.362)
13	CH44	14.8 (0.583)	8.70 (0.343)	7.70 (0.303)	8.70 (0.343)	9.20 (0.362)
16	CH51	3.80 (0.150)	10.7 (0.421)	9.66 (0.380)	10.66 (0.420)	10.7 (0.421)
18	CH52	7.40 (0.291)	10.7 (0.421)	9.66 (0.380)	10.66 (0.420)	10.7 (0.421)
20	CH53	11.1 (0.437)	10.7 (0.421)	9.66 (0.380)	10.66 (0.420)	10.7 (0.421)
22	CH54	14.8 (0.583)	10.7 (0.421)	9.66 (0.380)	10.66 (0.420)	10.7 (0.421)
25	CH61	3.80 (0.150)	13.6 (0.535)	13.5 (0.531)	14.5 (0.571)	14.9 (0.587)
27	CH62	7.40 (0.291)	13.6 (0.535)	13.5 (0.531)	14.5 (0.571)	14.9 (0.587)
29	CH63	11.1 (0.437)	13.6 (0.535)	13.5 (0.531)	14.5 (0.571)	14.9 (0.587)
31	CH64	14.8 (0.583)	13.6 (0.535)	13.5 (0.531)	14.5 (0.571)	14.9 (0.587)
34	CH71	3.80 (0.150)	21.6 (0.850)	14.74 (0.580)	15.74 (0.620)	16.8 (0.661)
36	CH72	7.40 (0.291)	21.6 (0.850)	14.74 (0.580)	15.74 (0.620)	16.8 (0.661)
38	CH73	11.1 (0.437)	21.6 (0.850)	14.74 (0.580)	15.74 (0.620)	16.8 (0.661)
40	CH74	14.8 (0.583)	21.6 (0.850)	14.74 (0.580)	15.74 (0.620)	16.8 (0.661)
43	CH76	3.80 (0.150)	16.6 (0.654)	19.52 (0.769)	21.12 (0.831)	21.6 (0.850)
45	CH77	7.40 (0.291)	16.6 (0.654)	19.52 (0.769)	21.12 (0.831)	21.6 (0.850)
47	CH78	11.1 (0.437)	16.6 (0.654)	19.52 (0.769)	21.12 (0.831)	21.6 (0.850)
49	CH79	14.8 (0.583)	16.6 (0.654)	19.52 (0.769)	21.12 (0.831)	21.6 (0.850)
51	CH81	3.80 (0.150)	38.2 (1.504)	9.66 (0.380)	10.66 (0.420)	12.0 (0.472)
53	CH82	7.40 (0.291)	38.2 (1.504)	9.66 (0.380)	10.66 (0.420)	12.0 (0.472)
55	CH83	11.1 (0.437)	38.2 (1.504)	9.66 (0.380)	10.66 (0.420)	12.0 (0.472)
57	CH84	14.8 (0.583)	38.2 (1.504)	9.66 (0.380)	10.66 (0.420)	12.0 (0.472)
59	CH86	3.80 (0.150)	38.2 (1.504)	14.74 (0.580)	15.74 (0.620)	18.9 (0.744)
61	CH87	7.40 (0.291)	38.2 (1.504)	14.74 (0.580)	15.74 (0.620)	18.9 (0.744)
63	CH88	11.1 (0.437)	38.2 (1.504)	14.74 (0.580)	15.74 (0.620)	18.9 (0.744)
65	CH89	14.8 (0.583)	38.2 (1.504)	14.74 (0.580)	15.74 (0.620)	18.9 (0.744)
67	CH91	3.80 (0.150)	40.6 (1.598)	19.52 (0.769)	21.12 (0.831)	24.0 (0.945)
69	CH92	7.40 (0.291)	40.6 (1.598)	19.52 (0.769)	21.12 (0.831)	24.0 (0.945)
71	CH93	11.1 (0.437)	40.6 (1.598)	19.52 (0.769)	21.12 (0.831)	24.0 (0.945)
73	CH94	14.8 (0.583)	40.6 (1.598)	19.52 (0.769)	21.12 (0.831)	24.0 (0.945)

ESCC DETAIL SPECIFICATION NO. 3001/034 PHYSICAL DIMENSIONS – CH STYLE, L

Millimeters (Inches)

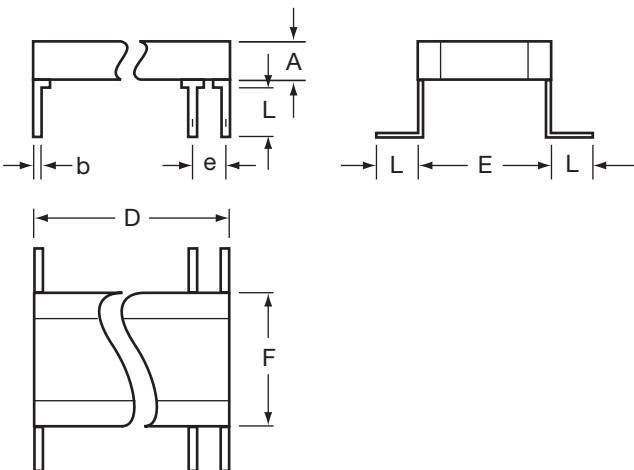

Variant	Case Size	A	D	E		F
		Max.	Max.	Min.	Max.	Max.
10	CH41	3.80 (0.150)	8.70 (0.343)	7.70 (0.303)	8.70 (0.343)	9.20 (0.362)
13	CH51	3.80 (0.150)	10.7 (0.421)	9.66 (0.380)	10.66 (0.420)	10.7 (0.421)
16	CH61	3.80 (0.150)	13.6 (0.535)	13.5 (0.531)	14.5 (0.571)	14.9 (0.587)
19	CH76	3.80 (0.150)	16.6 (0.654)	19.52 (0.769)	21.12 (0.831)	21.6 (0.850)
22	CH91	3.80 (0.150)	40.6 (1.598)	19.52 (0.769)	21.12 (0.831)	24.0 (0.945)

Symbol	Min.	Max.	Notes
b	0.45 (0.018)	0.55 (0.022)	1
e	2.49 (0.098)	2.59 (0.102)	2
L	2.04 (0.080)	3.01 (0.120)	1

Notes: 1 – All leads
2 – Each space

SMPS LVT Details & Physical Dimensions

ESCC DETAIL SPECIFICATION NO. 3001/030

PHYSICAL DIMENSIONS – BR STYLE

Millimeters (Inches)

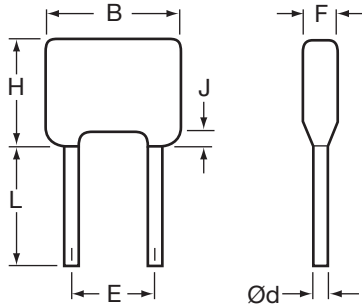

Variant	Case Size	B		Ød		E		F	H	J	L
		Max.	Min.	Max.	Min.	Max.	Max.	Max.	Max.	Max.	Min.
01	BR40	10.16 (0.400)	0.46 (0.018)	0.56 (0.022)	4.58 (0.180)	5.58 (0.220)	5.00 (0.197)	11.7 (0.461)	1.50 (0.059)	31.7 (1.248)	
02	BR50	12.7 (0.500)	0.59 (0.023)	0.69 (0.027)	9.66 (0.380)	10.66 (0.420)	5.10 (0.201)	14.2 (0.559)	1.50 (0.059)	31.7 (1.248)	
03	BR66	17.5 (0.689)	0.86 (0.034)	0.96 (0.038)	14.2 (0.559)	15.2 (0.598)	6.40 (0.252)	16.5 (0.650)	1.50 (0.059)	31.7 (1.248)	
04	BR72	19.3 (0.760)	0.86 (0.034)	0.96 (0.038)	14.74 (0.580)	15.74 (0.620)	6.40 (0.252)	24.0 (0.945)	1.50 (0.059)	31.7 (1.248)	
05	BR84	23.62 (0.930)	0.71 (0.028)	0.81 (0.032)	18.93 (0.745)	20.83 (0.820)	6.40 (0.252)	19.78 (0.779)	1.50 (0.059)	31.7 (1.248)	

ESCC DETAIL SPECIFICATION NO. 3001/030

PHYSICAL DIMENSIONS – CV STYLE

Millimeters (Inches)

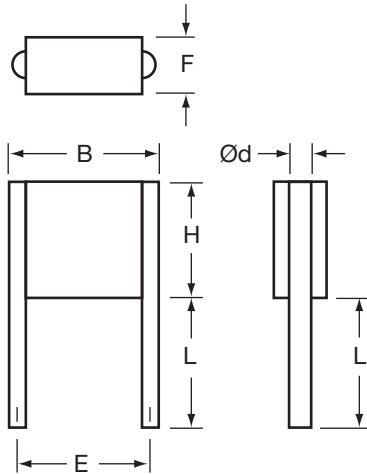

Variant	Case Size	B		Ød		E		F	H	L
		Max.	Min.	Max.	Min.	Max.	Max.	Max.	Max.	Min.
06	CV41	10.6 (0.417)	0.65 (0.026)	0.75 (0.030)	7.70 (0.303)	8.70 (0.343)	3.80 (0.150)	8.70 (0.343)	22.0 (0.866)	28.0 (1.102)
15	CV51	11.9 (0.469)	0.85 (0.033)	0.95 (0.037)	9.66 (0.380)	10.66 (0.420)	3.80 (0.150)	10.7 (0.421)	22.0 (0.866)	28.0 (1.102)
24	CV61	16.5 (0.650)	0.85 (0.033)	0.95 (0.037)	14.74 (0.580)	15.74 (0.620)	3.80 (0.150)	13.6 (0.535)	22.0 (0.866)	28.0 (1.102)
33	CV71	17.8 (0.701)	0.85 (0.033)	0.95 (0.037)	14.74 (0.580)	15.74 (0.620)	3.80 (0.150)	21.6 (0.850)	22.0 (0.866)	28.0 (1.102)
42	CV76	22.7 (0.894)	0.85 (0.033)	0.95 (0.037)	20.4 (0.803)	22.0 (0.866)	3.80 (0.150)	16.6 (0.654)	22.0 (0.866)	28.0 (1.102)

SMPS LVT Details & Physical Dimensions

ESCC DETAIL SPECIFICATION NO. 3001/030 PHYSICAL DIMENSIONS – CH STYLE, D.I.L.

Millimeters (Inches)

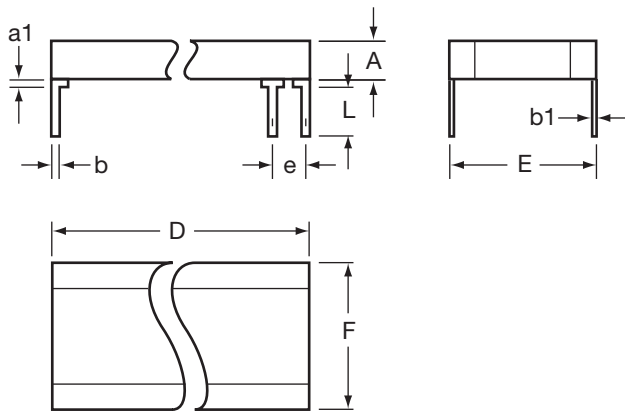

Symbol	Min.	Max.	Notes
a1	-	2.00 (0.079)	1
b	0.45 (0.018)	0.55 (0.022)	1
b1	0.204 (0.008)	0.304 (0.012)	1
e	2.49 (0.098)	2.59 (0.102)	2
L	2.04 (0.080)	3.04 (0.120)	1

Notes: 1 – All leads
2 – Each space

Variant	Case Size	A	D	E		F
		Max.	Max.	Min.	Max.	Max.
07	CH41	3.80 (0.150)	8.70 (0.343)	7.70 (0.303)	8.70 (0.343)	9.20 (0.362)
09	CH42	7.40 (0.291)	8.70 (0.343)	7.70 (0.303)	8.70 (0.343)	9.20 (0.362)
11	CH43	11.1 (0.437)	8.70 (0.343)	7.70 (0.303)	8.70 (0.343)	9.20 (0.362)
13	CH44	14.8 (0.583)	8.70 (0.343)	7.70 (0.303)	8.70 (0.343)	9.20 (0.362)
16	CH51	3.80 (0.150)	10.7 (0.421)	9.66 (0.380)	10.66 (0.420)	10.7 (0.421)
18	CH52	7.40 (0.291)	10.7 (0.421)	9.66 (0.380)	10.66 (0.420)	10.7 (0.421)
20	CH53	11.1 (0.437)	10.7 (0.421)	9.66 (0.380)	10.66 (0.420)	10.7 (0.421)
22	CH54	14.8 (0.583)	10.7 (0.421)	9.66 (0.380)	10.66 (0.420)	10.7 (0.421)
25	CH61	3.80 (0.150)	13.6 (0.535)	13.5 (0.531)	14.5 (0.571)	14.9 (0.587)
27	CH62	7.40 (0.291)	13.6 (0.535)	13.5 (0.531)	14.5 (0.571)	14.9 (0.587)
29	CH63	11.1 (0.437)	13.6 (0.535)	13.5 (0.531)	14.5 (0.571)	14.9 (0.587)
31	CH64	14.8 (0.583)	13.6 (0.535)	13.5 (0.531)	14.5 (0.571)	14.9 (0.587)
34	CH71	3.80 (0.150)	21.6 (0.850)	14.74 (0.580)	15.74 (0.620)	16.8 (0.661)
36	CH72	7.40 (0.291)	21.6 (0.850)	14.74 (0.580)	15.74 (0.620)	16.8 (0.661)
38	CH73	11.1 (0.437)	21.6 (0.850)	14.74 (0.580)	15.74 (0.620)	16.8 (0.661)
40	CH74	14.8 (0.583)	21.6 (0.850)	14.74 (0.580)	15.74 (0.620)	16.8 (0.661)
43	CH76	3.80 (0.150)	16.6 (0.654)	19.52 (0.769)	21.12 (0.831)	21.6 (0.850)
45	CH77	7.40 (0.291)	16.6 (0.654)	19.52 (0.769)	21.12 (0.831)	21.6 (0.850)
47	CH78	11.1 (0.437)	16.6 (0.654)	19.52 (0.769)	21.12 (0.831)	21.6 (0.850)
49	CH79	14.8 (0.583)	16.6 (0.654)	19.52 (0.769)	21.12 (0.831)	21.6 (0.850)
51	CH81	3.80 (0.150)	38.2 (1.504)	9.66 (0.380)	10.66 (0.420)	12.0 (0.472)
53	CH82	7.40 (0.291)	38.2 (1.504)	9.66 (0.380)	10.66 (0.420)	12.0 (0.472)
55	CH83	11.1 (0.437)	38.2 (1.504)	9.66 (0.380)	10.66 (0.420)	12.0 (0.472)
57	CH84	14.8 (0.583)	38.2 (1.504)	9.66 (0.380)	10.66 (0.420)	12.0 (0.472)
59	CH86	3.80 (0.150)	38.2 (1.504)	14.74 (0.580)	15.74 (0.620)	18.9 (0.744)
61	CH87	7.40 (0.291)	38.2 (1.504)	14.74 (0.580)	15.74 (0.620)	18.9 (0.744)
63	CH88	11.1 (0.437)	38.2 (1.504)	14.74 (0.580)	15.74 (0.620)	18.9 (0.744)
65	CH89	14.8 (0.583)	38.2 (1.504)	14.74 (0.580)	15.74 (0.620)	18.9 (0.744)
67	CH91	3.80 (0.150)	40.6 (1.598)	19.52 (0.769)	21.12 (0.831)	24.0 (0.945)
69	CH92	7.40 (0.291)	40.6 (1.598)	19.52 (0.769)	21.12 (0.831)	24.0 (0.945)
71	CH93	11.1 (0.437)	40.6 (1.598)	19.52 (0.769)	21.12 (0.831)	24.0 (0.945)
73	CH94	14.8 (0.583)	40.6 (1.598)	19.52 (0.769)	21.12 (0.831)	24.0 (0.945)

ESCC DETAIL SPECIFICATION NO. 3001/030 PHYSICAL DIMENSIONS – CH STYLE, L

Millimeters (Inches)

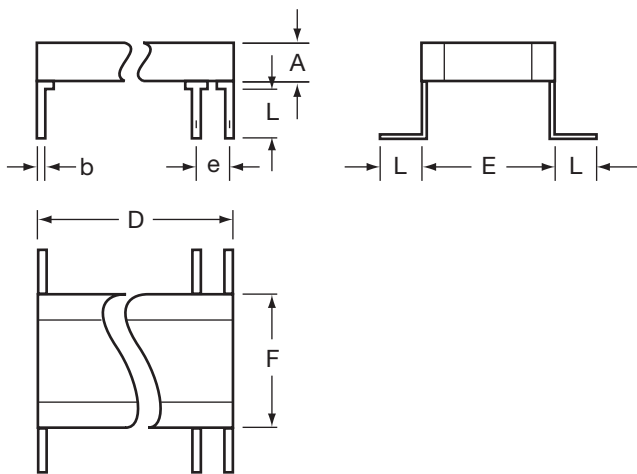

Symbol	Min.	Max.	Notes
b	0.45 (0.018)	0.55 (0.022)	1
e	2.49 (0.098)	2.59 (0.102)	2
L	2.04 (0.080)	3.04 (0.120)	1

Notes: 1 – All leads
2 – Each space

Variant	Case Size	A	D	E		F
		Max.	Max.	Min.	Max.	Max.
08	CH41	3.80 (0.150)	8.70 (0.343)	7.70 (0.303)	8.70 (0.343)	9.20 (0.362)
10	CH42	7.40 (0.291)	8.70 (0.343)	7.70 (0.303)	8.70 (0.343)	9.20 (0.362)
12	CH43	11.1 (0.437)	8.70 (0.343)	7.70 (0.303)	8.70 (0.343)	9.20 (0.362)
14	CH44	14.8 (0.583)	8.70 (0.343)	7.70 (0.303)	8.70 (0.343)	9.20 (0.362)
17	CH51	3.80 (0.150)	10.7 (0.421)	9.66 (0.380)	10.66 (0.420)	10.7 (0.421)
19	CH52	7.40 (0.291)	10.7 (0.421)	9.66 (0.380)	10.66 (0.420)	10.7 (0.421)
21	CH53	11.1 (0.437)	10.7 (0.421)	9.66 (0.380)	10.66 (0.420)	10.7 (0.421)
23	CH54	14.8 (0.583)	10.7 (0.421)	9.66 (0.380)	10.66 (0.420)	10.7 (0.421)
26	CH61	3.80 (0.150)	13.6 (0.535)	13.5 (0.531)	14.5 (0.571)	14.9 (0.587)
28	CH62	7.40 (0.291)	13.6 (0.535)	13.5 (0.531)	14.5 (0.571)	14.9 (0.587)
30	CH63	11.1 (0.437)	13.6 (0.535)	13.5 (0.531)	14.5 (0.571)	14.9 (0.587)
32	CH64	14.8 (0.583)	13.6 (0.535)	13.5 (0.531)	14.5 (0.571)	14.9 (0.587)
35	CH71	3.80 (0.150)	21.6 (0.850)	14.74 (0.580)	15.74 (0.620)	16.8 (0.661)
37	CH72	7.40 (0.291)	21.6 (0.850)	14.74 (0.580)	15.74 (0.620)	16.8 (0.661)
39	CH73	11.1 (0.437)	21.6 (0.850)	14.74 (0.580)	15.74 (0.620)	16.8 (0.661)
41	CH74	14.8 (0.583)	21.6 (0.850)	14.74 (0.580)	15.74 (0.620)	16.8 (0.661)
44	CH76	3.80 (0.150)	16.6 (0.654)	19.52 (0.769)	21.12 (0.831)	21.6 (0.850)
46	CH77	7.40 (0.291)	16.6 (0.654)	19.52 (0.769)	21.12 (0.831)	21.6 (0.850)
48	CH78	11.1 (0.437)	16.6 (0.654)	19.52 (0.769)	21.12 (0.831)	21.6 (0.850)
50	CH79	14.8 (0.583)	16.6 (0.654)	19.52 (0.769)	21.12 (0.831)	21.6 (0.850)
52	CH81	3.80 (0.150)	38.2 (1.504)	9.66 (0.380)	10.66 (0.420)	12.0 (0.472)
54	CH82	7.40 (0.291)	38.2 (1.504)	9.66 (0.380)	10.66 (0.420)	12.0 (0.472)
56	CH83	11.1 (0.437)	38.2 (1.504)	9.66 (0.380)	10.66 (0.420)	12.0 (0.472)
58	CH84	14.8 (0.583)	38.2 (1.504)	9.66 (0.380)	10.66 (0.420)	12.0 (0.472)
60	CH86	3.80 (0.150)	38.2 (1.504)	14.74 (0.580)	15.74 (0.620)	18.9 (0.744)
62	CH87	7.40 (0.291)	38.2 (1.504)	14.74 (0.580)	15.74 (0.620)	18.9 (0.744)
64	CH88	11.1 (0.437)	38.2 (1.504)	14.74 (0.580)	15.74 (0.620)	18.9 (0.744)
66	CH89	14.8 (0.583)	38.2 (1.504)	14.74 (0.580)	15.74 (0.620)	18.9 (0.744)
68	CH91	3.80 (0.150)	40.6 (1.598)	19.52 (0.769)	21.12 (0.831)	24.0 (0.945)
70	CH92	7.40 (0.291)	40.6 (1.598)	19.52 (0.769)	21.12 (0.831)	24.0 (0.945)
72	CH93	11.1 (0.437)	40.6 (1.598)	19.52 (0.769)	21.12 (0.831)	24.0 (0.945)
74	CH94	14.8 (0.583)	40.6 (1.598)	19.52 (0.769)	21.12 (0.831)	24.0 (0.945)



QPL Certificates

QPL Certificates

Types covered by similarity: Capacitance tolerances 5%, 10%, 20%		Remarks:		
Procurement Specifications	Manufacturer	Nature of Approval	Supervising Authority	Initial Qualification Date
Generic ESCC 3009 Detail ESCC 3009/041	KYOCERA AVX Limited Coleraine Northern Ireland	Qualification	ESA	April 2015
Characteristics: E12 value series Qualified Range: Variant 01 0402, Cn as in Detail specification, 5%, 10%, 20% tolerances, 16V, 25V, 50V, 100V rated Variant 02 0603, Cn as in Detail specification, 5%, 10%, 20% tolerances, 16V, 25V, 50V, 100V rated Variant 03 0805, Cn as in Detail specification, 5%, 10%, 20% tolerances, 16V, 25V, 50V, 100V rated Variant 04 1206, Cn as in Detail specification, 5%, 10%, 20% tolerances, 16V, 25V, 50V, 100V rated Variant 05 1210, Cn as in Detail specification, 5%, 10%, 20% tolerances, 16V, 25V, 50V, 100V rated Variant 06 1812, Cn as in Detail specification, 5%, 10%, 20% tolerances, 16V, 25V, 50V, 100V rated Variant 07 2220, Cn as in Detail specification, 5%, 10%, 20% tolerances, 16V, 25V, 50V, 100V rated Terminations: Cu and Ag-loaded epoxy + Ni barrier + Sn/Pb plating finish (10% Pb minimum) Operating Temperature Range (°C): -55 to +125				
	CAPACITORS, FIXED, CHIP, BASE METAL ELECTRODE, CERAMIC DIELECTRIC TYPE II, BASED ON TYPE TTP, 0402, 0603, 0805, 1206, 1210, 1812, 2220	Certificate 331A		Page 21 Issue 182

QPL Certificates

Types covered by similarity:				Remarks: Variant 01 removed					
Tolerance (\pm): 0.5pF, 2, 5, 20%									
Procurement Specifications			Manufacturer			Nature of Approval	Supervising Authority	Initial Qualification Date	
Generic ESCC 3009 Detail ESCC 3009/003 3009/004 3009/005 3009/006 3009/022			KYOCERA AVX/KYOCERA AVX St. Apollinaire France			Qualification	CNES	Feb 1983	
Characteristics: Operating Temp Range ($^{\circ}$ C), -55 to +125 Variants 03 and 06 are qualified Values covered by ESCC Specification defined below.									
Style	Model	Detail Spec	Variants	Capacitance Range (pF)	Rated Voltage (V)	Tolerance (+%)	TC (ppm/ $^{\circ}$ C)		
0805	A_12C	3009/003	03, 06	4.7 to 9.1 10 to 1500 1800 to 2200	50, 100 50, 100 50	0.5pF 1, 2, 5, 10 1, 2, 5, 10	\pm 30		
1206	A_20C	3009/022	03, 06	10 to 3900 ... to 4700	50, 100 50	1, 2, 5, 10	\pm 30		
1210	A_13C	3009/004	03, 06	22 to 6800 8200 to 10000	50, 100 50	1, 2, 5, 10	\pm 30		
1812	A_14C	3009/005	03, 06	100 to 15000	50, 100	1, 2, 5, 10	\pm 30		
2220	A_15C	3009/006	03, 06	470 to 33000	50, 100	1, 2, 5, 10	\pm 30		
				CAPACITORS, CERAMIC, FIXED, CHIP, TYPE I				Certificate 109 L	Page 01-02 001-1

QPL Certificates

Types covered by similarity:							Remarks: Variant 01 removed		
Tolerance ($\pm\%$): 10, 20%									
Procurement Specifications					Manufacturer		Nature of Approval	Supervising Authority	Initial Qualification Date
Generic ESCC 3009					KYOCERA AVX/ KYOCERA AVX St. Apollinaire France		Qualification	CNES	Feb 1983
Detail ESCC 3009/008, 3009/009, 3009/010, 3009/011, 3009/023									
Characteristics: See Table below. Operating Temp Range ($^{\circ}\text{C}$), -55 to +125.									
Style	Model	Detail Spec	Variants	Capacitance Range			Rated Voltage	Tolerance (+%)	
0805	A_12G	3009/008	03, 06	820	to	47000	25	5, 10, 20	
				820	to	27000	50	5, 10, 20	
				820	to	10000	100	5, 10, 20	
0805	A612Z	3009/008	07, 10	2700	to	150000	25	5, 10, 20	
				2700	to	100000	50		
				2700	to	47000	100		
				330	to	15000	200		
1210	A_13G	3009/009	03, 06	3900	to	220000	25	5, 10, 20	
				3900	to	150000	50	5, 10, 20	
				3900	to	47000	100	5, 10, 20	
1210	A613Z	3009/009	07, 10	3900	to	470000	25	5, 10, 20	
				3900	to	330000	50		
				3900	to	220000	100		
				680	to	68000	200		
1812	A_14G	3009/010	03, 06	6800	to	470000	25	5, 10, 20	
				6800	to	270000	50	5, 10, 20	
				6800	to	82000	100	5, 10, 20	
1812	A614Z	3009/010	07, 10	22000	to	1000000	25	5, 10, 20	
				22000	to	680000	50		
				22000	to	470000	100		
				3300	to	150000	200		
2220	A_15G	3009/011	03, 06	18000	to	1000000	25	5, 10, 20	
				18000	to	680000	50	5, 10, 20	
				18000	to	180000	100	5, 10, 20	
2220	A615Z	3009/011	07, 10	100000	to	2200000	25	5, 10, 20	
				100000	to	1500000	50		
				100000	to	1000000	100		
				6800	to	330000	200		
1206	A_20G	3009/023	03, 06	2200	to	100000	25	5, 10, 20	
				2200	to	68000	50	5, 10, 20	
				2200	to	22000	100	5, 10, 20	
1206	A620Z	3009/023	07, 10	3300	to	220000	25	5, 10, 20	
				3300	to	150000	50		
				3300	to	100000	100		
				470	to	47000	200		
Operating Temperature Range ($^{\circ}\text{C}$), -55 to +125									
				CAPACITORS, CERAMIC, FIXED, CHIP, TYPE II			Certificate 110 M rev1		Page 01-02 002-1A

QPL Certificates

Types covered by similarity: ±20% Tolerance		Remarks: Capacitors no longer use a varnish finish.		
Procurement Specifications	Manufacturer	Nature of Approval	Supervising Authority	Initial Qualification Date
Generic ESCC 3001 Detail ESCC 3001/030	KYOCERA AVX Limited Coleraine Northern Ireland	Qualification	DRA	Jul 1996
Characteristics: E12 series Qualified Range: Variants 01 to 74 capacitance range for 50V, 100V and 200V, as per Detail Specification Variants 01 to 52, and 59 to 60, for 500V are qualified ±10% tolerance Operating Temperature Range (°C): -55 to +125				
	CAPACITORS, CERAMIC, TYPE II, HIGH CAPACITANCE, BASED ON CASE STYLES BR, CV, AND CH	Certificate 109 L		Page 01-01 005

QPL Certificates

Types covered by similarity: ±20% Tolerance		Remarks:		
Procurement Specifications	Manufacturer	Nature of Approval	Supervising Authority	Initial Qualification Date
Generic ESCC 3001 Detail ESCC 3001/034	KYOCERA AVX Limited Coleraine Northern Ireland	Qualification	DERA	Sep 2000
Characteristics: E12 series Qualified Range: Variants 01 to 22 are qualified ±10% tolerance Operating Temperature Range (°C):-55 to +125				
	CAPACITORS, CERAMIC, TYPE II, HIGH VOLTAGE, 1.0 TO 5.0 KV, BASED ON CASE STYLES VR, CV, AND CH	Certificate 262 F	Page 01-01 006	

QPL Certificates

Types covered by similarity: ±20% Tolerance				Remarks:		
Procurement Specifications		Manufacturer		Nature of Approval	Supervising Authority	Initial Qualification Date
Generic ESCC 3009 Detail ESCC 3009/034		KYOCERA AVX Limited Coleraine Northern Ireland		Qualification	DERA	Feb 2001
Characteristics: E12 series Qualified Range: Variants 01 to 12 are qualified Terminations: Variants 01 to 12: metallised pads Operating Temperature Range (°C): -55 to +125	Style	Rated Voltage (kV)	Capacitance Range (pF)	Tolerance (±%)		
	1812	1.0	3,900 to 22,000	10		
		2.0	1,500 to 1,800	10		
		3.0	820 to 1,000	10		
	1825	1.0	27,000 to 56,000	10		
		2.0	2,200 to 6,800	10		
3.0		820 to 2,700	10			
		CAPACITORS, FIXED, CHIP, CERAMIC, TYPE II, HIGH VOLTAGE, BASED ON 1812 and 1825		Certificate 264 F		Page 01-02 004-1



FOLLOW US:     

VISIT US AT WWW.KYOCERA-AVX.COM 

A light gray world map is centered in the background of the lower half of the page. The map shows the continents of North America, South America, Europe, Africa, Asia, and Australia.

North America

Tel: +1 864-967-2150

Europe

Tel: +44 1276-697000

Asia

Tel: +65 6286-7555

Central America

Tel: +55 11-46881960

Japan

Tel: +81 740-321250