

FEATURES

- Patent pending
- Optimised bipolar output voltages for IGBT/ Mosfet gate drives
- Reinforced insulation to UL60950 recognition pending
- ANSI/AAMI ES60601-1 recognition pending
- 5.2kVDC isolation test voltage 'Hi Pot Test'
- Ultra low coupling capacitance
- Surface mount package style
- 5V, 12V & 24V inputs
- +15V/-9V, +15V/-5V & +19V/-5V outputs
- Operation to 100 °C
- Short circuit protection
- Thermal shutdown
- Characterised dv/dt immunity
- Characterised partial discharge performance
- DC link voltage 3kVDC

PRODUCT OVERVIEW

The MGJ1 series of DC-DC converters is ideal for powering 'high side' and 'low side' gate drive circuits for IGBTs and Mosfets in bridge circuits. A choice of asymmetric output voltages allows optimum drive levels for best system efficiency and EMI. The MGJ1 series is characterised for high isolation and dv/dt requirements commonly seen in bridge circuits used in motor drives and inverters, while the MGJ1 industrial grade temperature rating and construction gives long service life and reliability.



For full details go to
www.murata-ps.com/rohs

SELECTION GUIDE

Order Code ¹	Nominal Input Voltage	Output Voltage 1	Output Voltage 2	Output Current 1	Output Current 2	Input Current at Rated Load	Output 1		Output 2	
	V	V	V	mA		%				
						Load Regulation (Typ)	Load Regulation (Max)	Load Regulation (Typ)	Load Regulation (Max)	
MGJ1D051505MPC	5	15	-5	50	50	320	7	8.1	0.3	0.5
MGJ1D051510MPC	5	15	-10	40	40	310	7.6	8.7	0	0.1
MGJ1D051905MPC	5	19	-5	42	42	320	6.2	7.4	0.2	0.3
MGJ1D121505MPC	12	15	-5	50	50	115	5.6	6	0.3	0.4
MGJ1D121509MPC	12	15	-9	42	42	115	6.6	7.6	0	0.1
MGJ1D121905MPC	12	19	-5	42	42	115	5.1	6	0.2	0.3
MGJ1D241505MPC	24	15	-5	50	50	65	3.8	5.2	0.2	0.3
MGJ1D241509MPC	24	15	-9	42	42	65	4.5	6	0	0.1
MGJ1D241905MPC	24	19	-5	42	42	65	3.4	4.5	0.2	0.3

SELECTION GUIDE (Continued)

Order Code ¹	Ripple & Noise (Typ) ³	Ripple & Noise (Max) ³	Efficiency (Min)	Efficiency (Typ)	Isolation Capacitance	MTTF ²	
	mVp-p		%		pF	MIL. kHrs	Tel. kHrs
MGJ1D051505MPC	15	30	60	63.5	5	1964	70733
MGJ1D051510MPC	14	30	60	64	5	1872	65924
MGJ1D051905MPC	14	30	61	64.5	5	1816	55135
MGJ1D121505MPC	10	20	67	71.5	5	2214	39194
MGJ1D121509MPC	10	20	68	73	5	2069	37971
MGJ1D121905MPC	10	20	67	72	5	1908	37172
MGJ1D241505MPC	15	30	57	64	5	1500	33052
MGJ1D241509MPC	15	30	60	64	5	1378	31761
MGJ1D241905MPC	15	30	58	64	5	1356	29139

INPUT CHARACTERISTICS

Parameter	Conditions	Min.	Typ.	Max.	Units
Voltage range	Continuous operation, 5V input types	4.5	5	5.5	V
	Continuous operation, 12V input types	10.8	12	13.2	
	Continuous operation, 24V input types	21.6	24	26.4	
Input short circuit current I_{sc}	5V input types		125		mA
	12V input types		55		
	24V input types		80		
Input reflected ripple	5V input types		7.5		mA p-p
	12V input types		2		
	24V input types		2.5		

1. Components are supplied in tape and reel packaging, please refer to package specification section. Orderable part numbers are MGJ1D051505MPC-R7 (80 pieces per reel), or MGJ1D051505MPC-R13 (400 pieces per reel).

2. Calculated using MIL-HDBK-217 FN2 and Telcordia SR-332 calculation model with nominal input voltage at full load.

3. See ripple & noise test method.

All specifications typical at $T_a=25^{\circ}\text{C}$, nominal input voltage and rated output current unless otherwise specified

OUTPUT CHARACTERISTICS						
Parameter	Conditions	Min.	Typ.	Max.	Units	
Rated Power	T _A =-40°C to 105°C			1.0	W	
Voltage Set Point Accuracy	See tolerance envelopes					
Line regulation	051505	High V _{IN} to low V _{IN} OP1		1.38	1.45	%/%
		High V _{IN} to low V _{IN} OP2		0.06	0.08	
	051510	High V _{IN} to low V _{IN} OP1		1.68	1.75	
		High V _{IN} to low V _{IN} OP2		0.01	0.01	
	051905	High V _{IN} to low V _{IN} OP1		1.32	1.40	
		High V _{IN} to low V _{IN} OP2		0.05	0.06	
	121505	High V _{IN} to low V _{IN} OP1		1.56	1.62	
		High V _{IN} to low V _{IN} OP2		0.05	0.06	
	121509	High V _{IN} to low V _{IN} OP1		1.64	1.70	
		High V _{IN} to low V _{IN} OP2		0.006	0.01	
	121905	High V _{IN} to low V _{IN} OP1		1.29	1.32	
		High V _{IN} to low V _{IN} OP2		0.06	0.07	
	241505	High V _{IN} to low V _{IN} OP1		1.34	1.40	
		High V _{IN} to low V _{IN} OP2		0.07	0.10	
	241509	High V _{IN} to low V _{IN} OP1		1.61	1.70	
		High V _{IN} to low V _{IN} OP2		0.01	0.01	
241905	High V _{IN} to low V _{IN} OP1		1.26	1.32		
	High V _{IN} to low V _{IN} OP2		0.05	0.07		

ABSOLUTE MAXIMUM RATINGS	
Short-circuit protection	Continuous
Lead temperature 1mm from case for 10 seconds	245°C
Input voltage V _{IN} , MGJ1D05	7V
Input voltage V _{IN} , MGJ1D12	15V
Input voltage V _{IN} , MGJ1D24	28V

ISOLATION CHARACTERISTICS					
Parameter	Conditions	Min.	Typ.	Max.	Units
Isolation test voltage	Production tested for 1 second	5200			VDC
	Qualification tested for 1 minute	5200			VDC
Resistance	Viso= 500VDC	1			GΩ

GENERAL CHARACTERISTICS					
Parameter	Conditions	Min.	Typ.	Max.	Units
Switching frequency	5V input types		90		kHz
	12V input types		95		
	24V input types		115		

TEMPERATURE CHARACTERISTICS					
Parameter	Conditions	Min.	Typ.	Max.	Units
Specification	All output types (see derating curves)	-40		105	°C
Storage		-55		125	
Product Temperature above ambient	5V input types		23		
	12V input types		17		
	24V input types		26		
Cooling	Free air convection				

POSITIVE OUTPUT VOLTAGE TOLERANCE ENVELOPES

The voltage tolerance envelopes show typical load regulation characteristics for this product series. The tolerance envelope is the maximum output voltage variation due to changes in output loading and set point accuracy.

051505, 051905

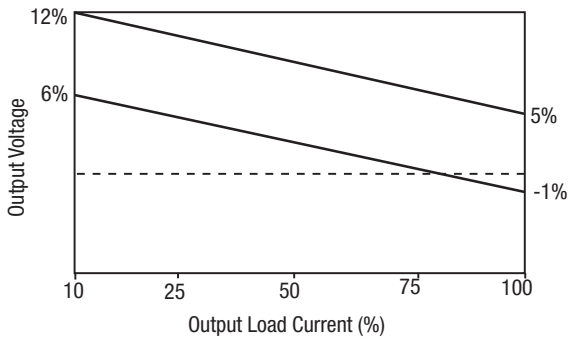

051510

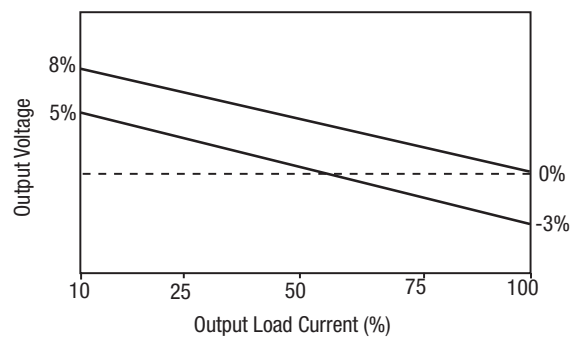

121505, 121905

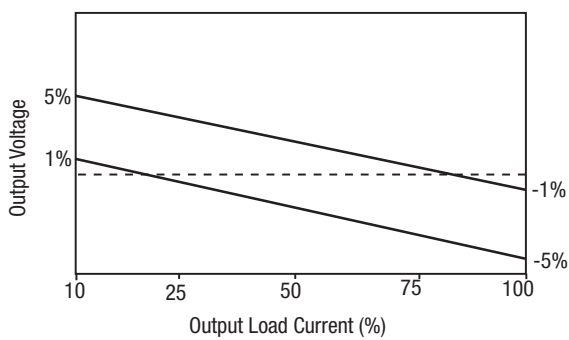

121509

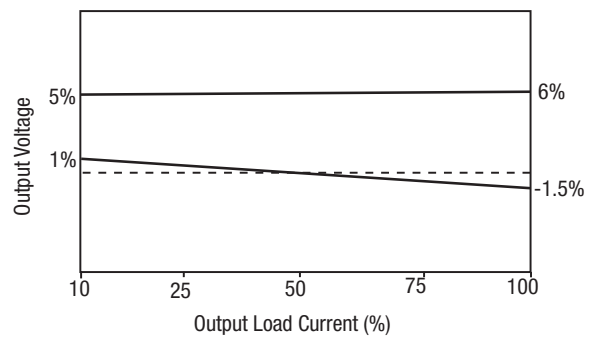

241505, 241509, 241905

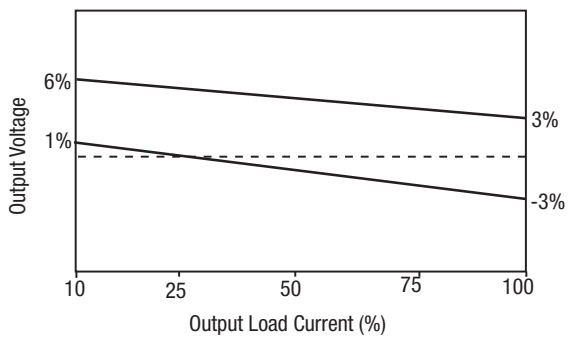

NEGATIVE OUTPUT VOLTAGE TOLERANCE ENVELOPES

051505, 121505, 121905, 241505, 241905

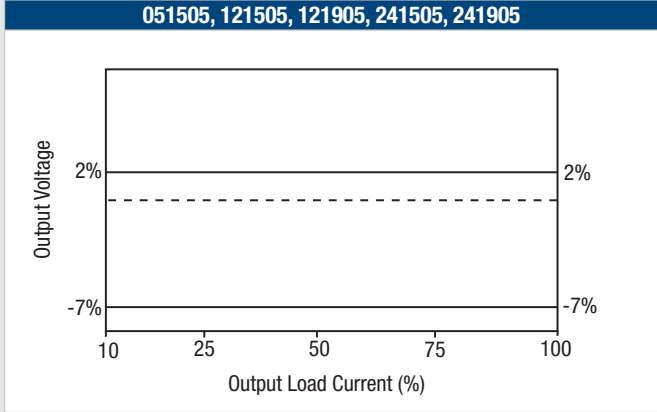

051510, 121509, 241509

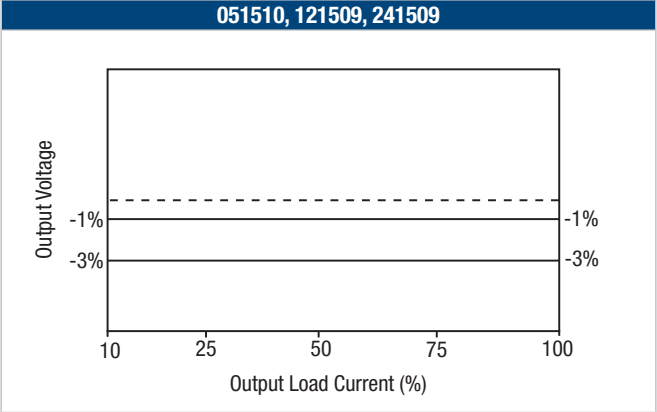

051905

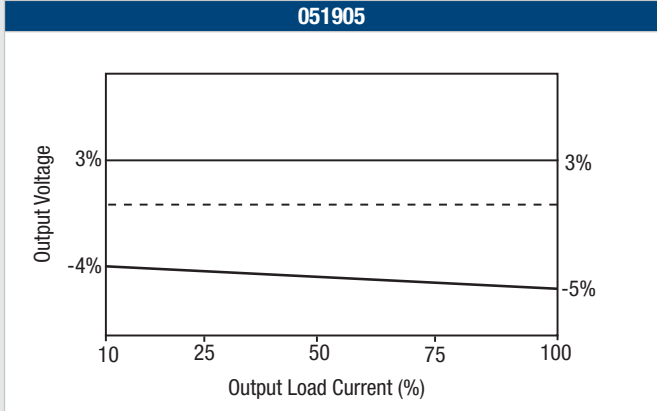

TECHNICAL NOTES

ISOLATION VOLTAGE

'Hi Pot Test', 'Flash Tested', 'Withstand Voltage', 'Proof Voltage', 'Dielectric Withstand Voltage' & 'Isolation Test Voltage' are all terms that relate to the same thing, a test voltage, applied for a specified time, across a component designed to provide electrical isolation, to verify the integrity of that isolation.

Murata Power Solutions MGJ1 series of DC/DC converters are all 100% production tested at 5.2kVDC for 1 second and have been qualification tested at 5.2kVDC for 1 minute.

A question commonly asked is, "What is the continuous voltage that can be applied across the part in normal operation?"

When the insulation in the MGJ1 series is not used as a safety barrier, i.e. provides functional isolation only, continuous or switched voltages across the barrier up to 3kV are sustainable. Long term reliability testing at these voltages continues. Peak Inception voltages measured were in excess of 3kV when testing for partial discharge in accordance with IEC 60270. Please contact Murata for further information.

The MGJ1 series is pending recognition by Underwriters Laboratory to 250 Vrms Reinforced Insulation, please see safety approval section below.

REPEATED HIGH-VOLTAGE ISOLATION TESTING

It is well known that repeated high-voltage isolation testing of a barrier component can actually degrade isolation capability, to a lesser or greater degree depending on materials, construction and environment. We therefore strongly advise against repeated high voltage isolation testing, but if it is absolutely required, that the voltage be reduced by 20% from specified test voltage.

SAFETY APPROVAL

ANSI/AAMI ES60601-1

The MGJ1 series is pending recognition ANSI/AAMI ES60601-1.

UL 60950

The MGJ1 series is pending recognition by Underwriters Laboratory (UL) to UL 60950 for reinforced insulation to a working voltage of 250Vrms with a maximum measured product operating temperature of 105°C.

Creepage and clearance 9.3mm.

FUSING

The MGJ1 Series of converters are not internally fused so to meet the requirements of UL an anti-surge input line fuse should always be used with ratings as defined below. Input Voltage, 5V 600mA

Input Voltage, 12V 250mA

Input Voltage, 24V 125mA

All fuses should be Anti-Surge and UL rated.

RoHS COMPLIANCE, MSL AND PSL INFORMATION



This series is compatible with Pb-Free soldering systems and is also backward compatible with Sn/Pb soldering systems. The MGJ1 series has a process, moisture, and reflow sensitivity classification of MSL2 PSL R7F as defined in J-STD-020 and J-STD-075. This translates to: MSL2 = 1 year floor life, PSL R7F = Peak reflow temperature 245°C with a limitation on the time above liquidus (217°C) which for this series is 90sec max. The pin termination finish on this product series is Gold with a plating thickness of 0.12 microns.

APPLICATION NOTES

Minimum load

The minimum load to meet datasheet specification is 10% of the full rated load across the specified input voltage range. Lower than 10% minimum loading will result in an increase in output voltage, which may rise to typically 1.25 times the specified output voltage if the output load falls to less than 5%.

Capacitive loading and start up

Typical start up times for this series, with a typical input voltage rise time of 2.2µs and output capacitance of 10µF, are shown in the table below. The product series will start into capacitance ranging up to 47µF (Capacitor across +V to -V or 100µF across each output) with increased start times.

	Start-up time ms
MGJ1D051505MPC	4.2
MGJ1D051509MPC	5
MGJ1D051905MPC	5.2
MGJ1D121505MPC	2.8
MGJ1D121509MPC	3.9
MGJ1D121905MPC	4
MGJ1D241505MPC	1
MGJ1D241509MPC	1.3
MGJ1D241905MPC	1.3

Typical Start-Up Wave Form

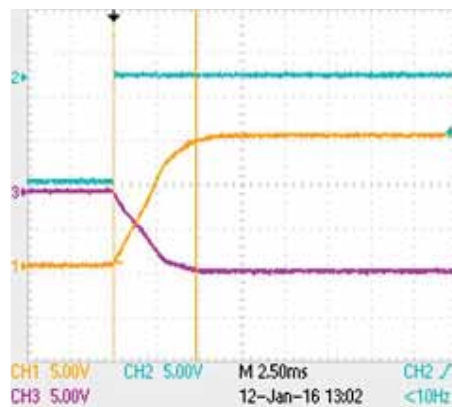

Ripple & Noise Characterisation Method

Ripple and noise measurements are performed with the following test configuration.

C1	1µF X7R multilayer ceramic capacitor, voltage rating to be a minimum of 3 times the output voltage of the DC/DC converter
C2	10µF tantalum capacitor, voltage rating to be a minimum of 1.5 times the output voltage of the DC/DC converter with an ESR of less than 100mΩ at 100 kHz
C3	100nF multilayer ceramic capacitor, general purpose
R1	450Ω resistor, carbon film, ±1% tolerance
R2	50Ω BNC termination
T1	3T of the coax cable through a ferrite toroid
RLOAD	Resistive load to the maximum power rating of the DC/DC converter. Connections should be made via twisted wires

Measured values are multiplied by 10 to obtain the specified values.

Differential Mode Noise Test Schematic

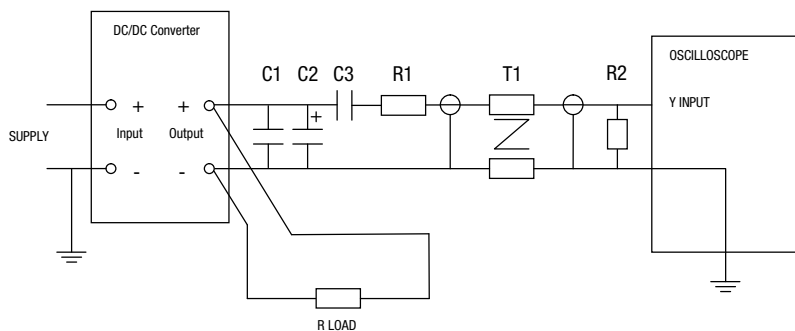

APPLICATION NOTES (Continued)

The converter provides a dual output, +Vout and -Vout by using a zener voltage divider network. The negative output is obtained by using a Zener diode as a voltage regulator. The zener diode is protected if a short circuit occurs. A 5V1 zener diode is used to set the -5Vout, a 9V1 zener diode to set the -9Vout and a 10V zener diode to set the -10Vout. Note that the zener diode tolerance should be taken into consideration. In this case 2% tolerance used. The 5V1 zener diode is rated at 300mW, the 9V1 and 10V zener are rated at 400mW.

The converter can also be used for general purpose as a single output, by loading from +Vout to -Vout.

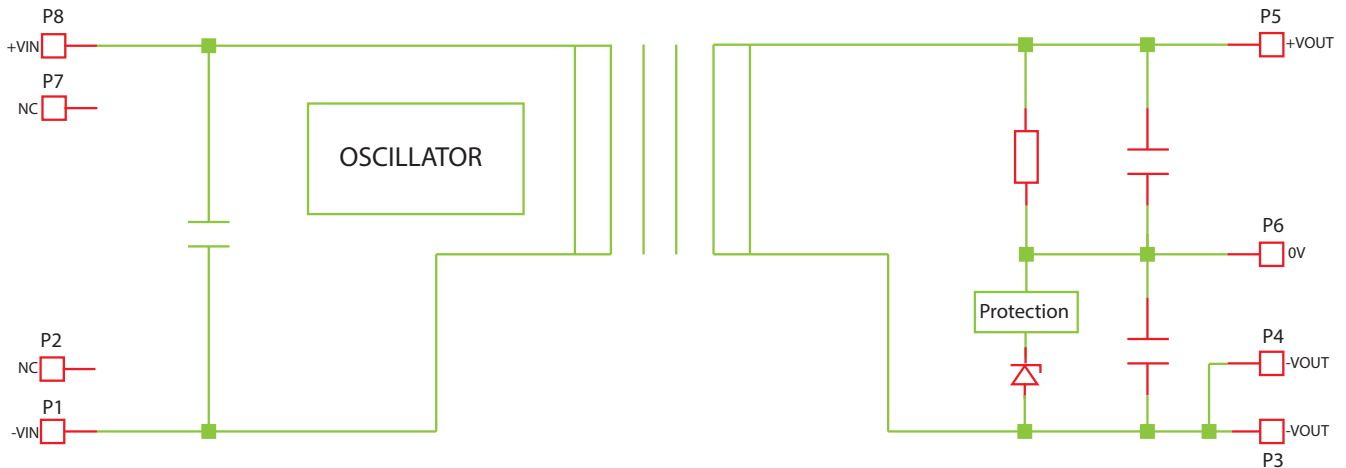

Optional Configuration:

For optional configuration where alternative negative output voltages are required, an external zener diode network can be connected across the main 20V or 24V output. However this zener diode will no longer be protected from short circuits as the internal short circuit protection is bypassed.

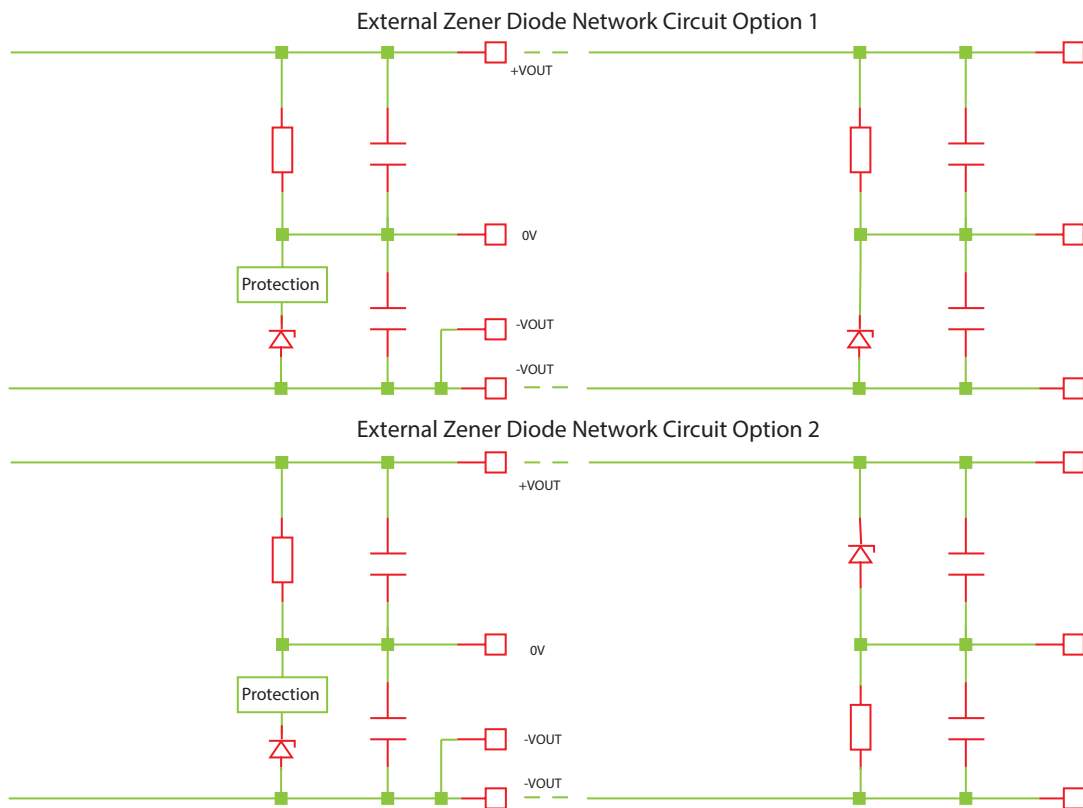

APPLICATION NOTES (Continued)

Schematic for driving IGBT, SiC & MOSFET

MGJ1 DC-DC CONNECTIONS FOR DRIVING IGBT DEVICES

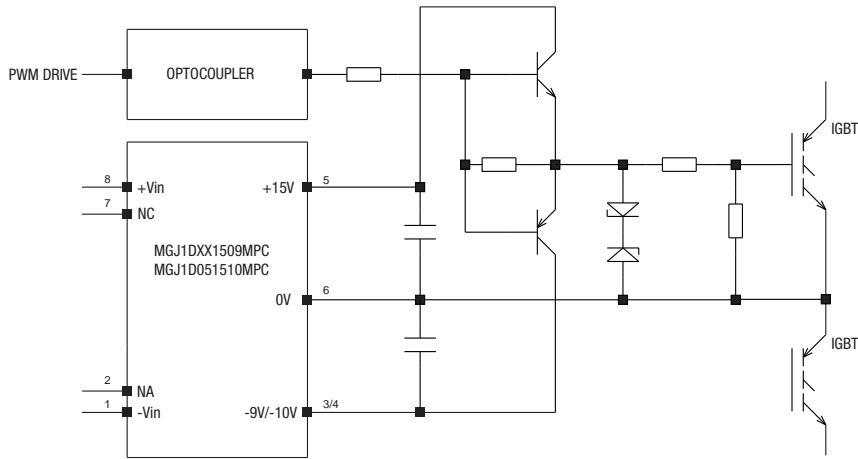

MGJ1 DC-DC CONNECTIONS FOR DRIVING SiC DEVICES

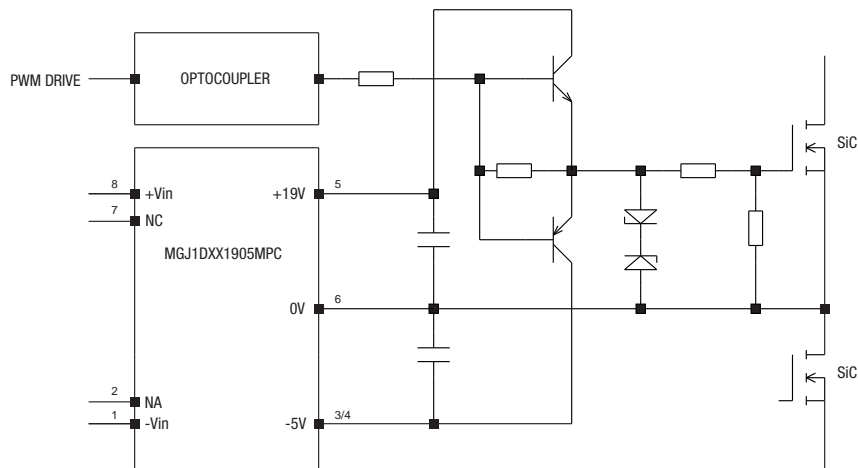

MGJ DC-DC CONNECTIONS FOR DRIVING MOSFET DEVICES

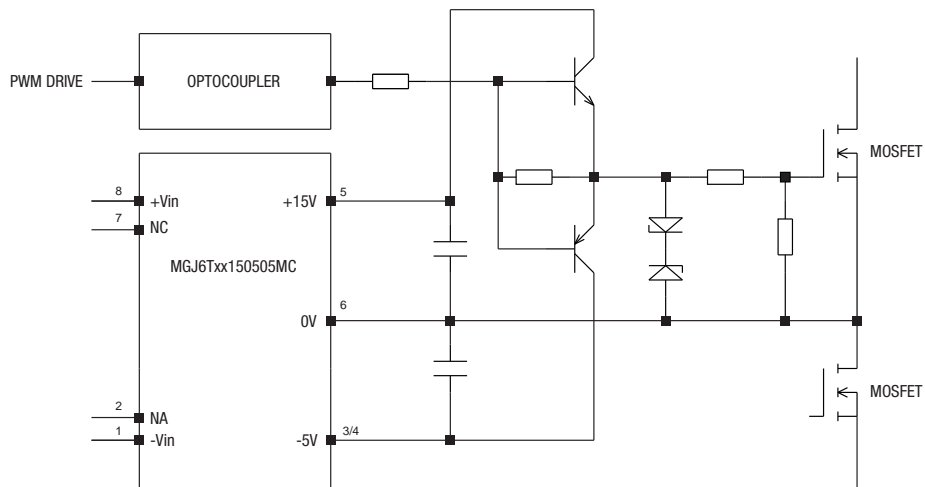

EFFICIENCY VS LOAD

MGJ1D051505MPC

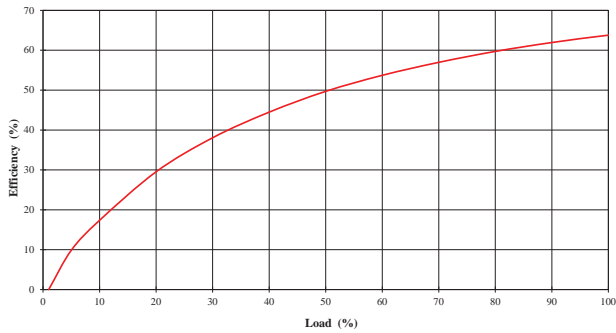

MGJ1D051510MPC

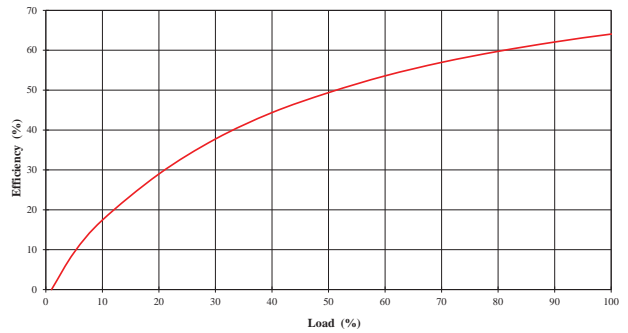

MGJ1D051905MPC

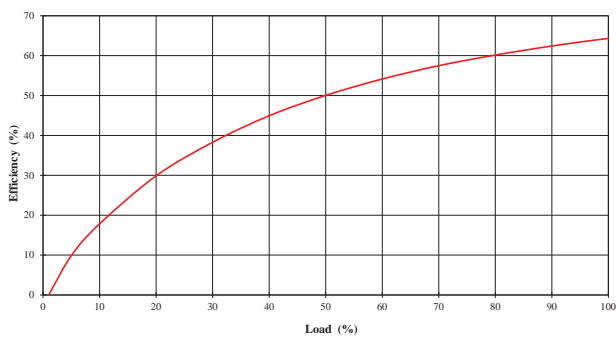

MGJ1D121505MPC

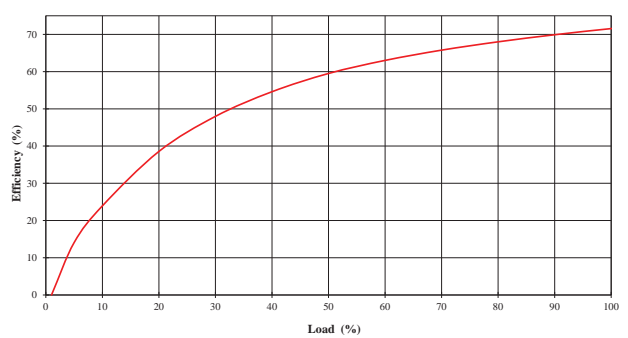

MGJ1D121509MPC

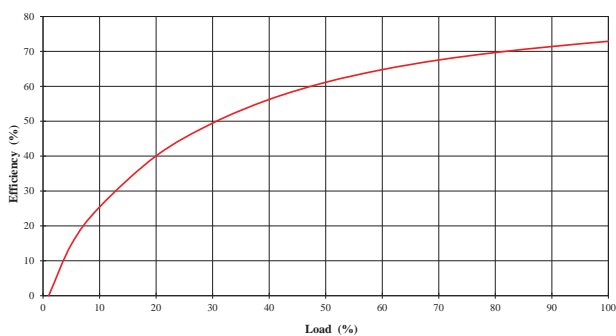

MGJ1D121905MPC

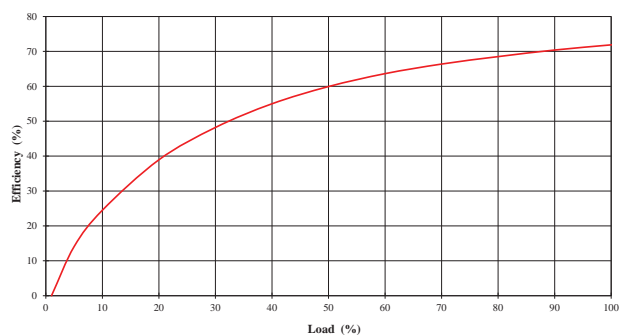

EFFICIENCY VS LOAD

MGJ1D241505MPC

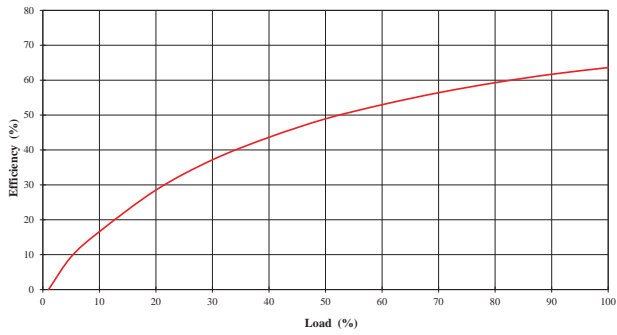

MGJ1D241509MPC

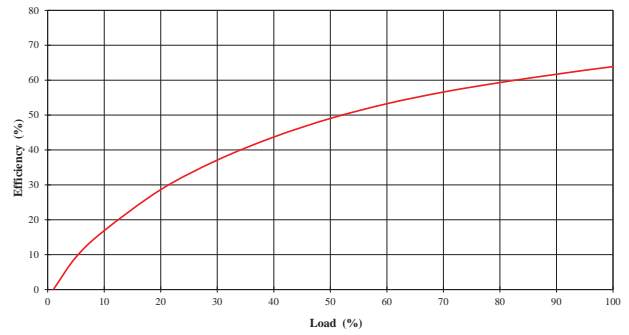

MGJ1D241905MPC

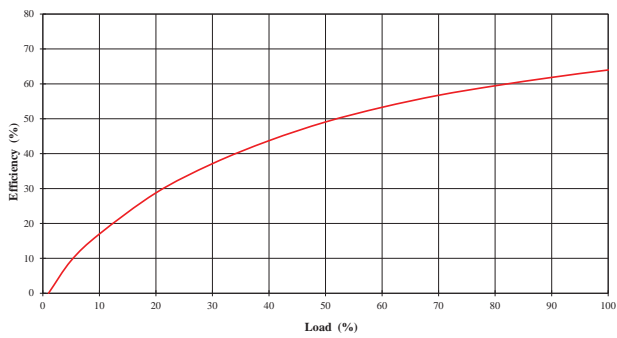

TEMPERATURE DERATING

MGJ1D051505MPC

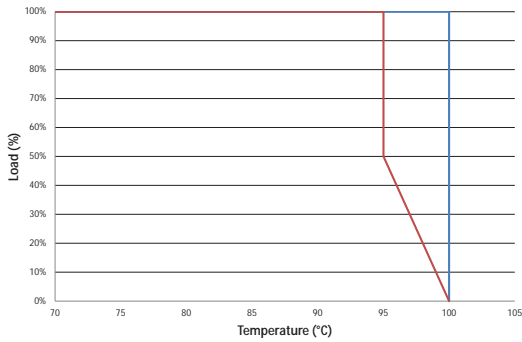

MGJ1D051510MPC

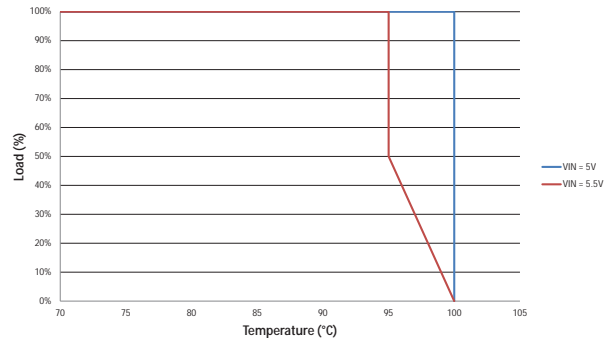

MGJ1D051905MPC

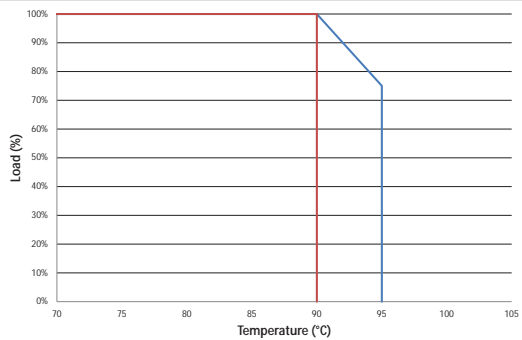

MGJ1D121505MPC

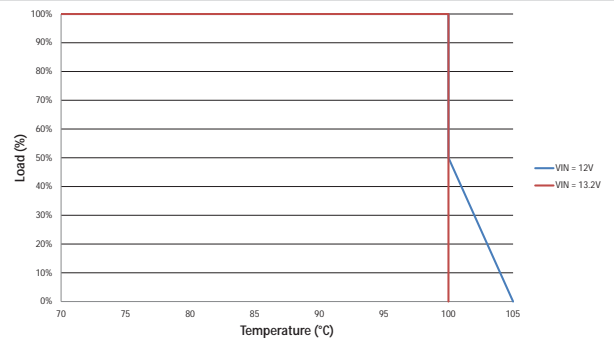

MGJ1D121509MPC

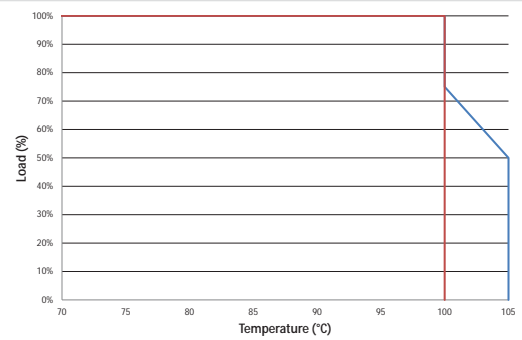

MGJ1D121905MPC

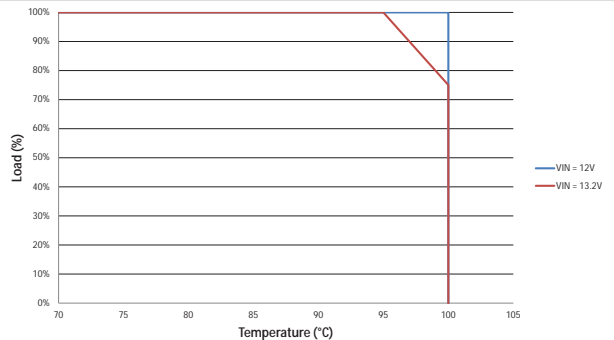

TEMPERATURE DERATING

MGJ1D241505MPC

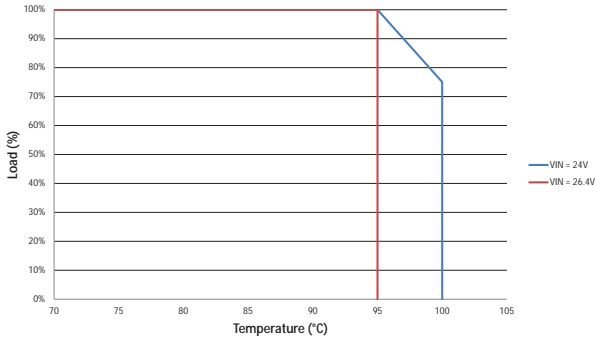

MGJ1D241509MPC

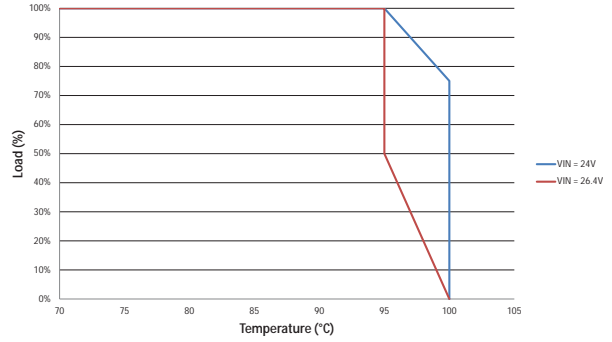

MGJ1D241905MPC

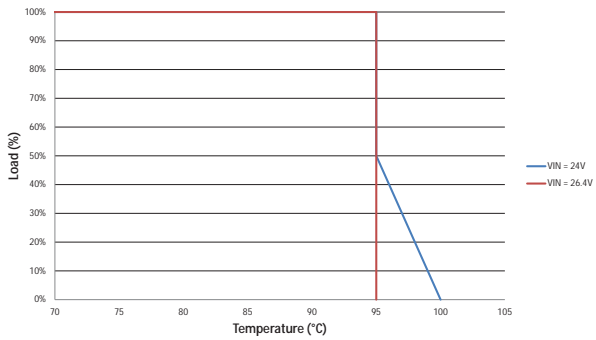

EMC FILTERING AND SPECTRA

FILTERING

An input capacitor and inductor is required to meet EN 55022 Curve B, Quasi-Peak EMC limit, as shown in the following plots. The following plots show positive and negative quasi peak and CISPR22 Average Limit B (green line) and Quasi Peak Limit B (pink line) adherence limits. The recommended input capacitor to use for this circuit is 10µF/50V. The recommended Murata part is GRM32ER71H106KA1Z.

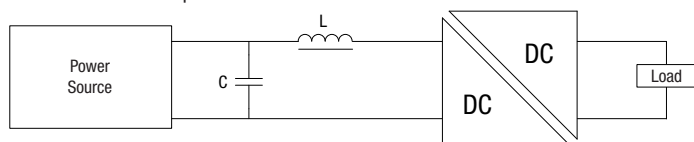

	Inductor			Capacitor
	L, µH	SMD	Through Hole	C, µF
MGJ1D051505MPC	15	46153C	13R153C	10
MGJ1D051510MPC	15	46153C	13R153C	10
MGJ1D051905MPC	15	46153C	13R153C	10
MGJ1D121509MPC	10	46103C	13R103C	10
MGJ1D121905MPC	10	46103C	13R103C	10
MGJ1D241505MPC	10	46103C	13R103C	10
MGJ1D241509MPC	6.8	46682C	13R682C	10
MGJ1D241905MPC	10	46682C	13R682C	10

MGJ1D051505MPC

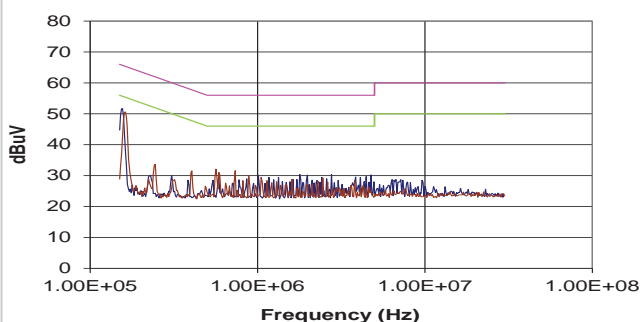

MGJ1D051510MPC

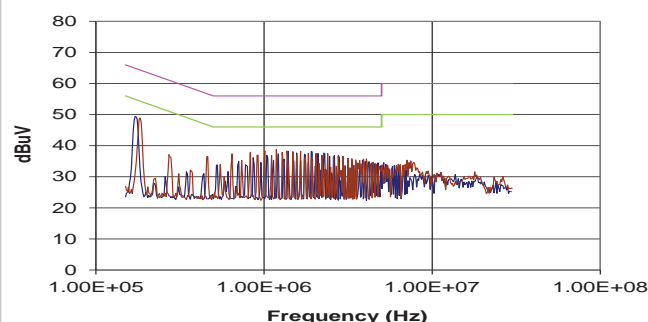

MGJ1D051905MPC

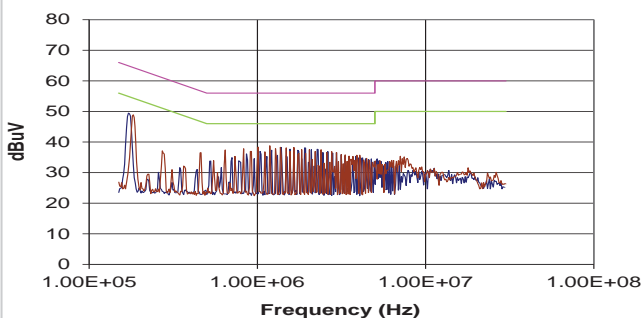

MGJ1D121505MPC

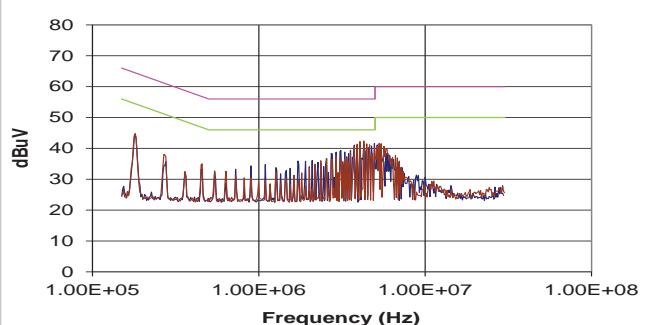

EMC FILTERING AND SPECTRA

MGJ1D121509MPC

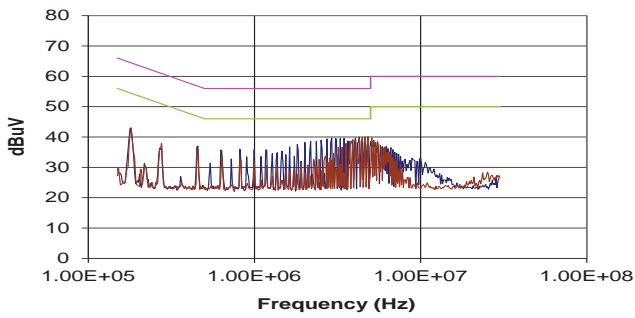

MGJ1D121905MPC

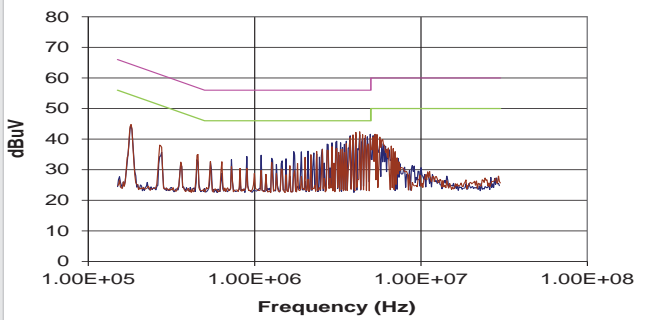

MGJ1D241505MPC

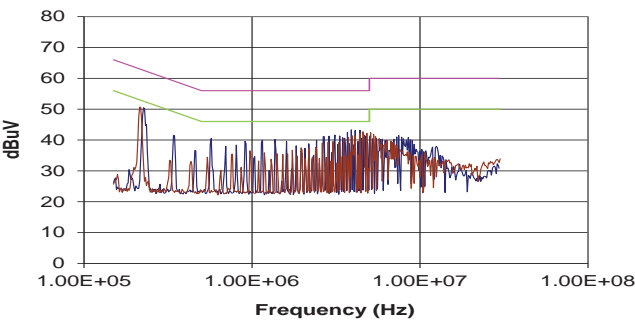

MGJ1D241509MPC

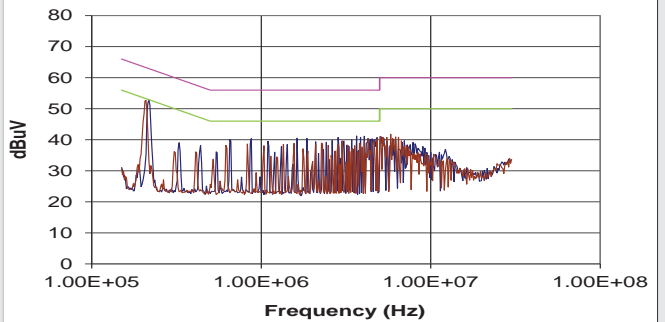

PACKAGE SPECIFICATIONS

MECHANICAL DIMENSIONS

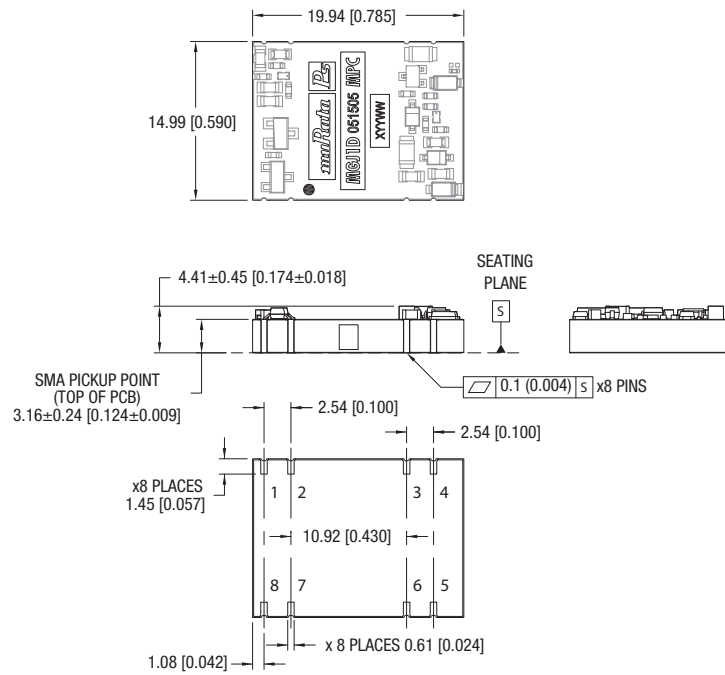

All dimensions in mm (inches). Controlling dimensions is mm.
Tolerance (unless otherwise stated) ±0.25 (0.010).
Weight: 2.3g

PIN CONNECTIONS

Pin	Function
1	-Vin
2	NA
3	-Vout
4	-Vout
5	+Vout
6	0V
7	NC
8	+Vin

NA - Not Available for electrical connection.

RECOMMENDED FOOTPRINT DETAILS

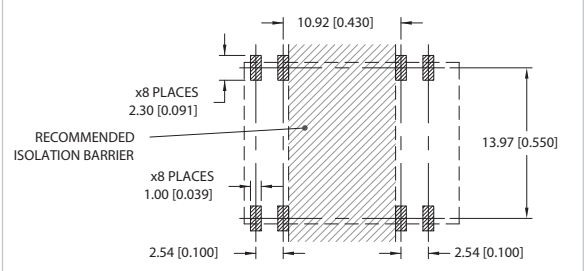

TAPE & REEL SPECIFICATIONS

REEL OUTLINE DIMENSIONS

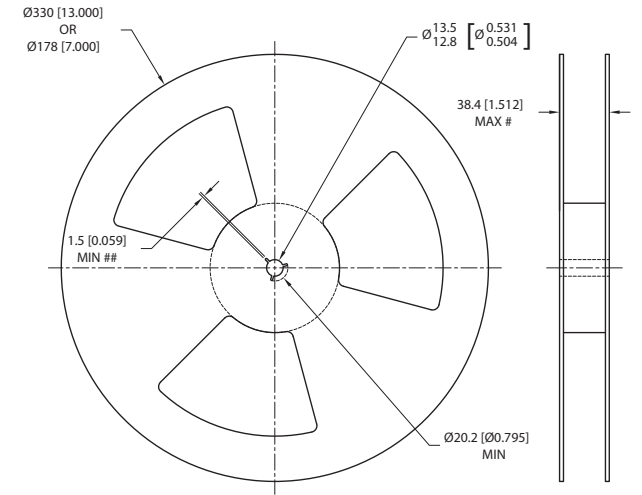

Tape & Reel specifications shall conform with current EIA-481 standard
 Unless otherwise stated all dimensions in mm(inches)
 Controlling dimension is mm
 # Measured at hub
 ## Six equi-spaced slots on 180mm/7" reel

REEL PACKAGING DETAILS

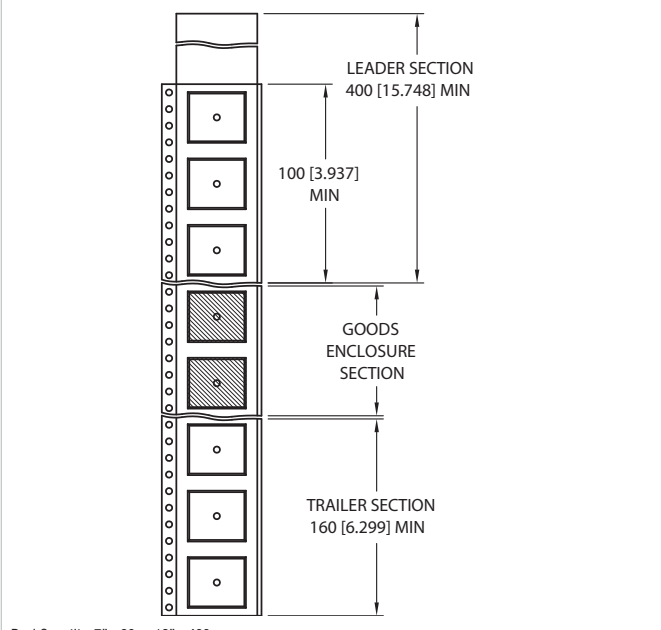

TAPE OUTLINE DIMENSIONS

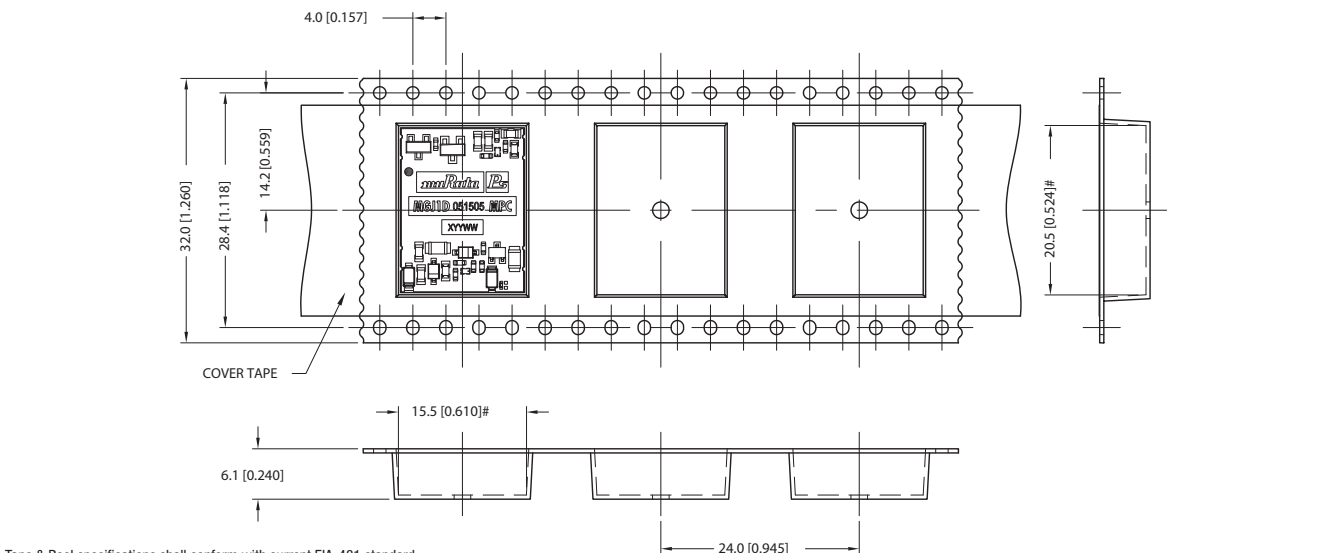

Tape & Reel specifications shall conform with current EIA-481 standard
 Unless otherwise stated all dimensions in mm(inches)
 Controlling dimension is mm
 Components shall be orientated within the carrier tape as indicated
 # Measured on a plane 0.3mm above the bottom pocket

Murata Power Solutions, Inc.
 11 Cabot Boulevard, Mansfield, MA 02048-1151 U.S.A.
 ISO 9001 and 14001 REGISTERED

This product is subject to the following [operating requirements](http://www.murata-ps.com/requirements/) and the [Life and Safety Critical Application Sales Policy](http://www.murata-ps.com/requirements/):
 Refer to: <http://www.murata-ps.com/requirements/>

Murata Power Solutions, Inc. makes no representation that the use of its products in the circuits described herein, or the use of other technical information contained herein, will not infringe upon existing or future patent rights. The descriptions contained herein do not imply the granting of licenses to make, use, or sell equipment constructed in accordance therewith. Specifications are subject to change without notice.
 © 2016 Murata Power Solutions, Inc.