

### FEATURES

- UL 60950 recognised for reinforced insulation
- ANSI/AAMI ES60601-1, 1 MOPP/ 2 MOOPs recognised
- 3kVAC isolation test voltage 'Hi Pot Test'
- Continuous short circuit protection
- Output Voltage Trim
- Remote on/off pin
- No electrolytic capacitors
- Operating temperature range -40°C to 105°C with derating
- 2:1 Input Range

### PRODUCT OVERVIEW

The MTC2 series of miniature surface mount DC-DC converters offers a single output voltage from input voltage ranges of 9-18V and 18-36V. The MTC2 series regulated output voltage is adjustable by  $\pm 10\%$  and a remote on/off pin is also included for application power saving.

The MTC2 ideally suited to applications which include medical, industrial, telecommunications, battery powered systems, and process automation.

### SELECTION GUIDE

Order Code <sup>1</sup>	Input Voltage	Output Voltage	Output Current	Rated Input Current	Efficiency		Ripple and Noise		MTTF <sup>2</sup>	
	Nom. V	V	mA	mA	Min. %	Typ. %	Typ. mVp/p	Max. mVp/p	MIL. kHrs	Tel. kHrs
MTC2S1203MC	12	3.3	606	210	76	78.5	40	50	997	15886
MTC2S1205MC	12	5	400	210	77	80	45	60	987	15761
MTC2S1212MC	12	12	167	200	81	83.5	45	60	985	15761
MTC2S2403MC	24	3.3	606	110	75	78.5	55	75	877	15230
MTC2S2405MC	24	5	400	100	76	79.5	35	55	795	15517
MTC2S2412MC	24	12	167	100	78	81.5	50	70	891	15638

### INPUT CHARACTERISTICS

Parameter	Conditions	Min.	Typ.	Max.	Units
Voltage range	12V input types	9	12	18	V
	24V input types	18	24	36	
Input reflected ripple current	All variants		4		mA p-p

### OUTPUT CHARACTERISTICS

Parameter	Conditions	Min.	Typ.	Max.	Units	
Rated power	All output types			2	W	
Minimal load to meet datasheet specification		10			%	
Voltage set point accuracy	All output types			$\pm 2$	%	
Line regulation	Low line to high line			$\pm 0.5$	%	
Load regulation	All output types			$\pm 0.5$	%	
Transient response	Peak deviation (25-75% & 75-25% swing)	3.3V output types			$\pm 8$	%V <sub>out</sub>
		12V output types			$\pm 2$	
		1205			$\pm 6$	
		2405			$\pm 5$	
	Settling time (1% V <sub>out</sub> Nom.)			45		$\mu$ s
			80			
			60			
			55			
			75			
			100			

### ISOLATION CHARACTERISTICS

Parameter	Conditions	Min.	Typ.	Max.	Units
Isolation test voltage	Production tested for 1 second	3000			VAC
	Qualification tested for 1 minute	5200			VDC
Isolation capacitance	All variants		20		pF
Resistance	Viso = 1kVDC	1			G $\Omega$



1. Components are supplied in tape and reel packaging, please refer to package specification section. Orderable part numbers are MTC2SXXXXMC-R7 (30 pieces per reel), or MTC2SXXXXMC-R13 (150 pieces per reel)
2. Calculated using MIL-HDBK-217 FN2 and Telecordia SR-332 calculation model with nominal input voltage at full load.

All specifications typical at T<sub>a</sub>=25°C, nominal input voltage and rated output current unless otherwise specified.

### GENERAL CHARACTERISTICS<sup>1</sup>

Parameter	Conditions	Min.	Typ.	Max.	Units
Switching frequency	1203		285		kHz
	1205, 1212		260		
	2403		185		
	2405		225		
	2412		240		
Remote on/off pin	Module on, pin unconnected or open collector floating				
	Module off (refer to application notes)	3.3V output types		3	V
		5V & 12V output types		2	
	1203, 1205		1.4		mW
	1212		1.5		
	2403, 2405		3.9		
2412		4.2			

### TEMPERATURE CHARACTERISTICS

Parameter	Conditions	Min.	Typ.	Max.	Units
Operation	See derating graphs	-40		105	°C
Storage		-50		125	
Case temperature above ambient	100% Load, Nom V <sub>IN</sub> , Still Air		22		

### ABSOLUTE MAXIMUM RATINGS

Short-circuit protection (for SELV input voltages)	Continuous
Remote on/off pin input voltage <sup>1</sup>	12V
Input voltage, MTC2 12V input types	25V
Input voltage, MTC2 24V input types	40V

### APPLICATION NOTES

#### Maximum Output Capacitance

Maximum output capacitance should not exceed:

Output Voltage	Maximum Load Capacitance
V	μF
3.3	470
5	470
12	220

#### Start-up times

Typical start up times for this series, with a typical input voltage rise time of 2.2μs and output capacitance of 470μF (3.3, 5V outputs) and 220μF (12V outputs), are shown in the table below. The product series will start into the maximum output capacitance with increased start times.

Part No.	Start-up times
	ms
MTC2S1203MC	3
MTC2S1205MC	10.5
MTC2S1212MC	31
MTC2S2403MC	7
MTC2S2405MC	12
MTC2S2412MC	21

Typical Wave Form:

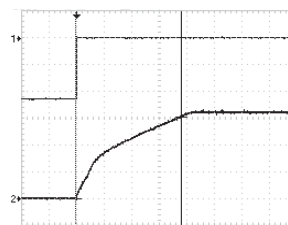

1. Provided that external control circuit is the same as application note on page 3.

**APPLICATION NOTES**

**Control Pin**

The MTC2 converters have a shutdown feature which enables the user to put the converter into a low power state. The control pin connects directly to the base of an internal transistor, and the switch off mechanism for the MTC2 works by forward biasing this NPN transistor. If the pin is left open (high impedance), the converter will be ON (there is no allowed low state for this pin), but once a control voltage is applied with sufficient drive current, the converter will be switched OFF. A suitable application circuit is shown below.

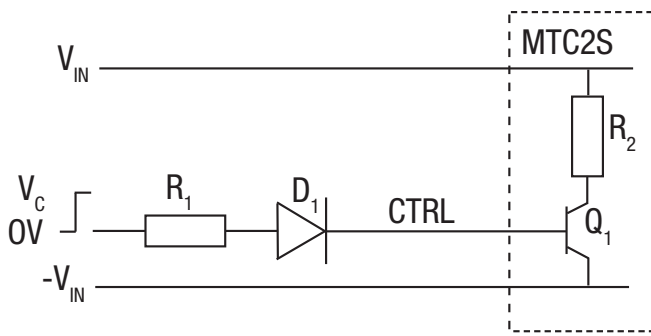

R1 - 86Ω  
D1 - 1N4001

ON: Open or high impedance  
OFF: 5V supply to 86Ω and 1N4001

**Output Voltage Adjustment**

The MTC2S series has a trim capability which is located at pin 3, this allows the user to independently adjust the output voltages by ±10%. Adjustments to the output voltages can be accomplished via a single fixed resistor as shown in Figures 1 and 2. A single fixed resistor can increase or decrease the output voltage depending on its connection. Fixed resistors should have low temperature coefficient to minimize sensitivity to changes in temperature.

A single resistor connected from the TRIM pin (pin 3) to the +Vout (pin 4), will decrease the output voltage which is shown in figure 1.

A single resistor connected from the TRIM pin (pin 3) to the -Vout (pin 2) will increase the output voltage which is shown in figure 2.

**TRIM DOWN**

Figure 1. Trim connections to decrease the output voltage

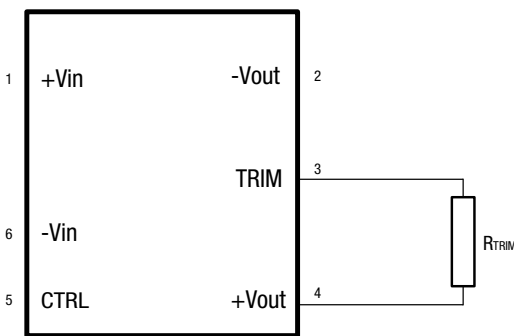

$$3.3V_{out} R_{TRIM} = \frac{18.64k \times V_{out} - 52.3k}{3.32 - V_{out}}$$

$$5V_{out} R_{TRIM} = \frac{33.2k \times V_{out} - 141k}{5 - V_{out}}$$

$$12V_{out} R_{TRIM} = \frac{24.4k \times V_{out} - 181.388k}{12.2087 - V_{out}}$$

**TRIM UP**

Figure 2. Trim connections to increase the output voltage

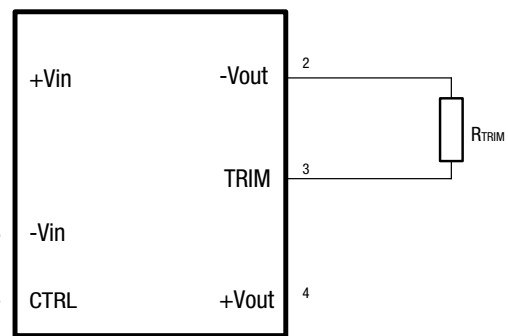

$$3.3V_{out} R_{TRIM} = \frac{14k \times V_{out} - 52.3k}{3.32 - V_{out}}$$

$$5V_{out} R_{TRIM} = \frac{23.2k \times V_{out} - 141k}{5 - V_{out}}$$

$$12V_{out} R_{TRIM} = \frac{12.4k \times V_{out} - 181.388k}{12.2087}$$

Accuracy of adjustment is subject to tolerances of resistors and factory adjusted output accuracy. Vout is equal to the desired output voltage.

## TECHNICAL NOTES

### ISOLATION VOLTAGE

'Hi Pot Test', 'Flash Tested', 'Withstand Voltage', 'Proof Voltage', 'Dielectric Withstand Voltage' & 'Isolation Test Voltage' are all terms that relate to the same thing, a test voltage, applied for a specified time, across a component designed to provide electrical isolation, to verify the integrity of that isolation.

Murata Power Solutions MTC2 series of DC-DC converters are all 100% production tested at 3kVAC for 1 second and have been qualification tested at 5.2kVDC for 1 minute.

A question commonly asked is, "What is the continuous voltage that can be applied across the part in normal operation?"

The MTC2 series has been recognised by Underwriters Laboratory to 250Vrms for Reinforced Insulation.

### REPEATED HIGH-VOLTAGE ISOLATION TESTING

It is well known that repeated high-voltage isolation testing of a barrier component can actually degrade isolation capability, to a lesser or greater degree depending on materials, construction and environment. We therefore strongly advise against repeated high voltage isolation testing, but if it is absolutely required, that the voltage be reduced by 20% from specified test voltage.

## SAFETY APPROVAL

### ANSI/AAMI ES60601-1

The MTC2 series has been recognised by Underwriters Laboratory (UL) to ANSI/AAMI ES60601-1 and provides 1 MOPP (Means Of Patient Protection) and 2 MOOP (Means Of Operator Protection) based upon a working voltage of 250 Vrms max., between Primary and Secondary. File number E202895 applies.

### UL 60950

The MTC2 series has been recognised by Underwriters Laboratory (UL) to UL 60950 for reinforced insulation to a working voltage of 250 Vrms with a maximum measured product operating temperature of 105°C. File number E151252 applies.

Creepage and clearance 5 mm.

### FUSING

The MTC2 Series of converters are not internally fused so to meet the requirements of UL an anti-surge input line fuse should always be used with ratings as defined below.

Input Voltage, 12V: 0.75A

Input Voltage, 24V: 0.5A

All fuses should be UL recognized and rated to at least the maximum allowable DC input voltage.

## CHARACTERISATION TEST METHODS

### Ripple & Noise Characterisation Method

Ripple and noise measurements are performed with the following test configuration.

C1	1µF X7R multilayer ceramic capacitor, voltage rating to be a minimum of 3 times the output voltage of the DC-DC converter
C2	10µF tantalum capacitor, voltage rating to be a minimum of 1.5 times the output voltage of the DC-DC converter with an ESR of less than 100mΩ at 100 kHz
C3	100nF multilayer ceramic capacitor, general purpose
R1	450Ω resistor, carbon film, ±1% tolerance
R2	50Ω BNC termination
T1	3T of the coax cable through a ferrite toroid
RLOAD	Resistive load to the maximum power rating of the DC-DC converter. Connections should be made via twisted wires

Measured values are multiplied by 10 to obtain the specified values.

### Differential Mode Noise Test Schematic

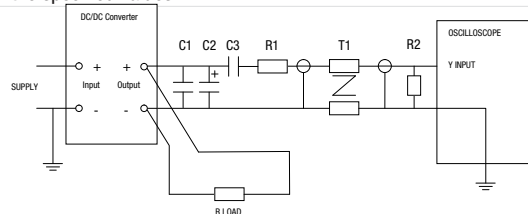

**EFFICIENCY VS LOAD**

**MTC2S1203MC**

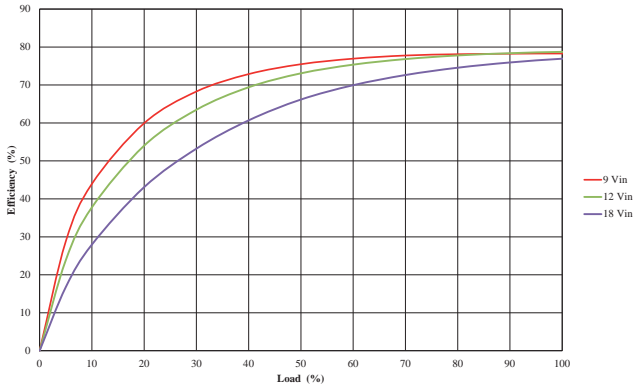

**MTC2S1205MC**

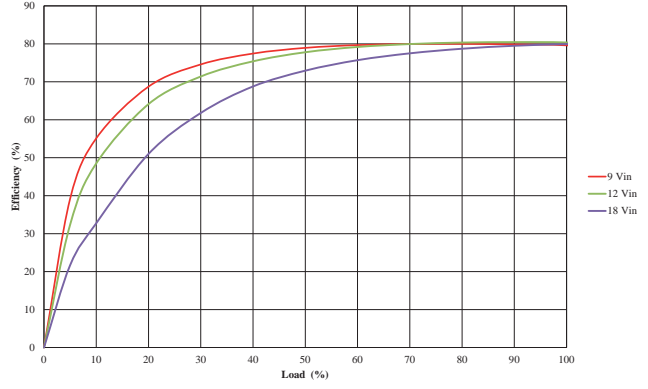

**MTC2S1212MC**

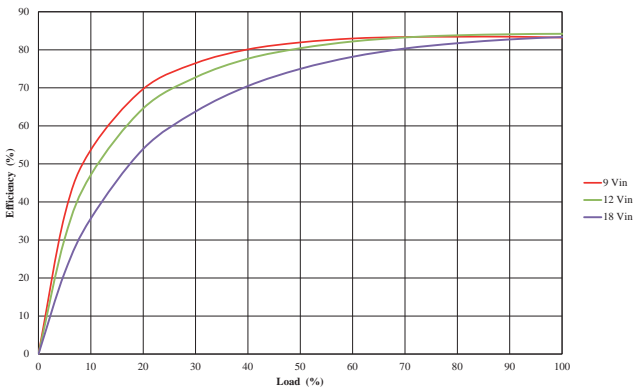

**MTC2S2403MC**

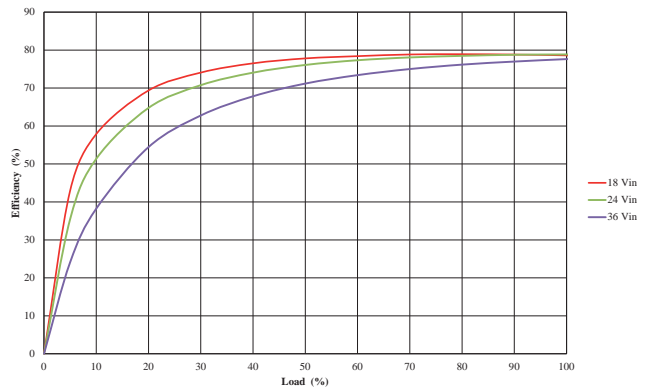

**MTC2S2405MC**

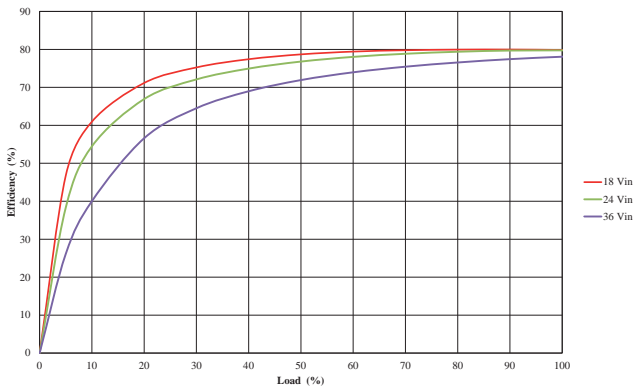

**MTC2S2412MC**

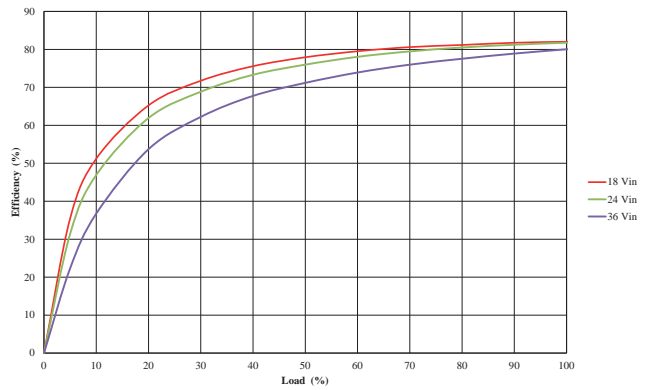

**DERATING GRAPHS**

**MTC2S1203MC - 12Vin**

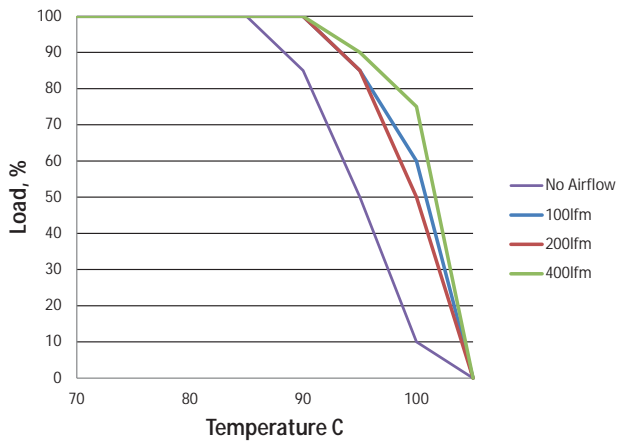

**MTC2S1205MC - 12Vin**

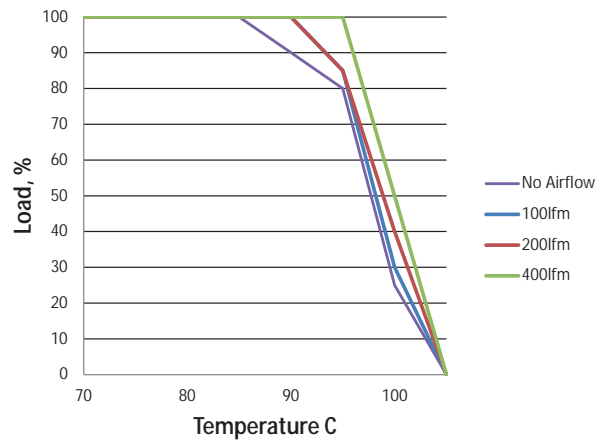

**MTC2S1212MC - 12Vin**

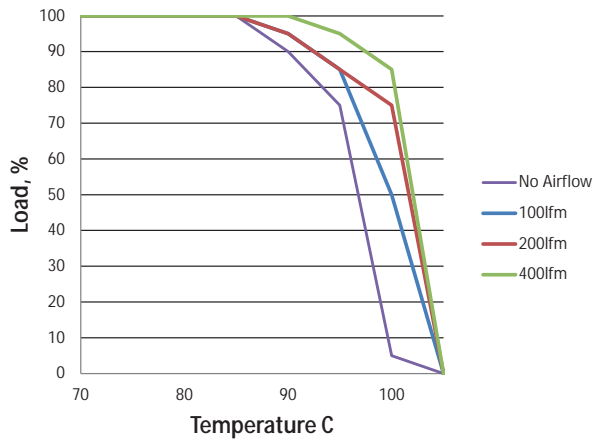

**MTC2S2403MC - 24Vin**

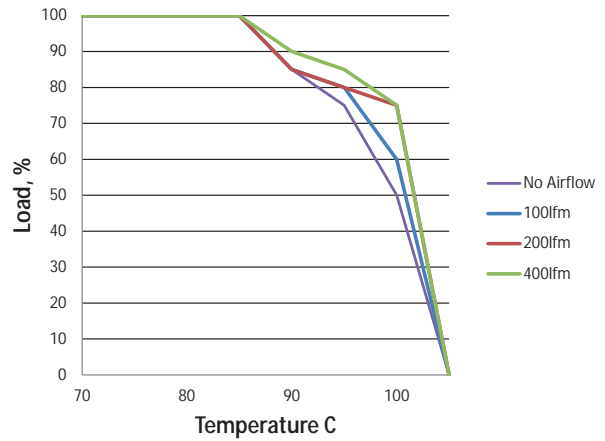

**MTC2S2405MC - 24Vin**

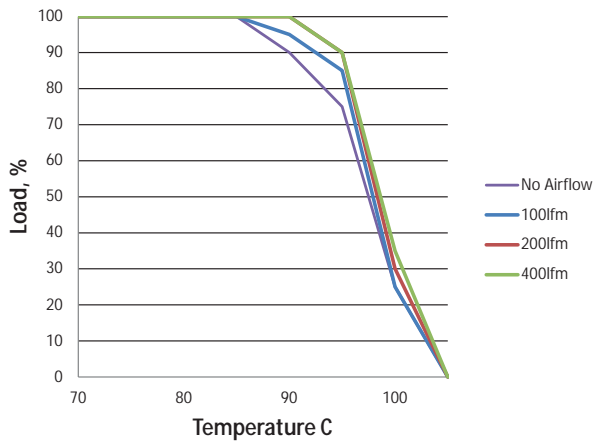

**MTC2S2412MC - 24Vin**

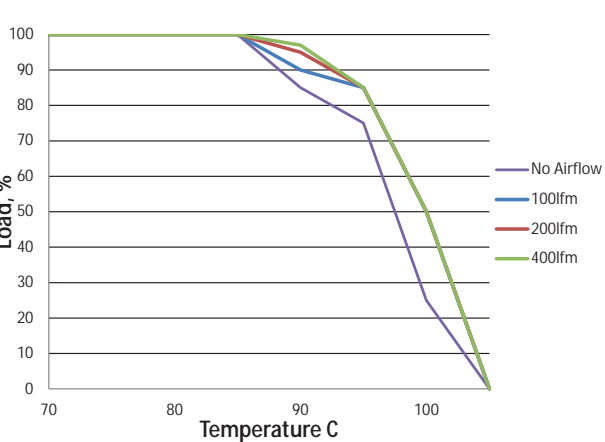

**DERATING GRAPHS**

**MTC2S1203MC - 9Vin**

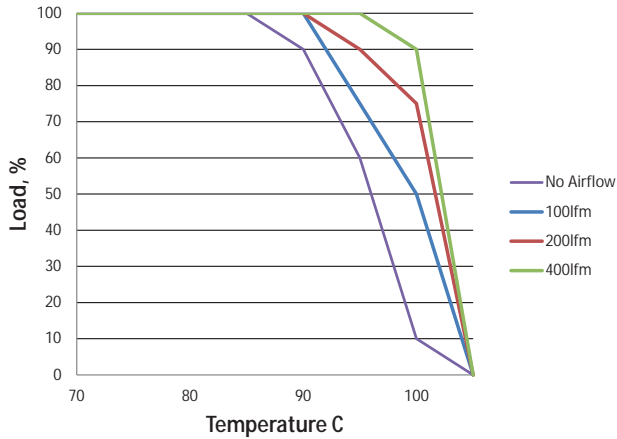

**MTC2S1205MC - 9Vin**

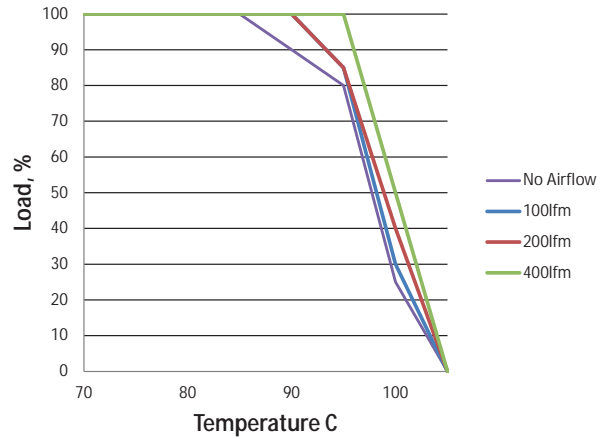

**MTC2S1212MC - 9Vin**

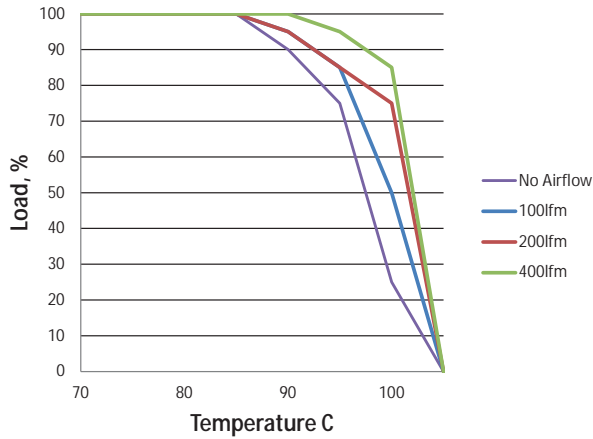

**MTC2S2403MC - 18Vin**

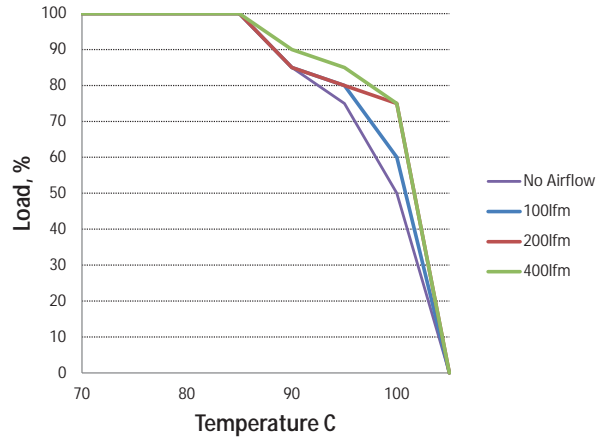

**MTC2S2405MC - 18Vin**

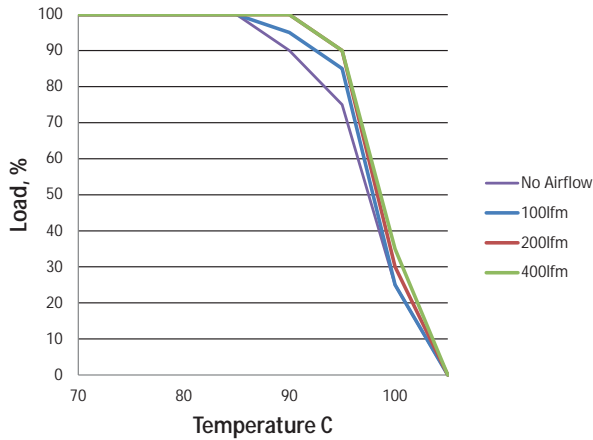

**MTC2S2412MC - 18Vin**

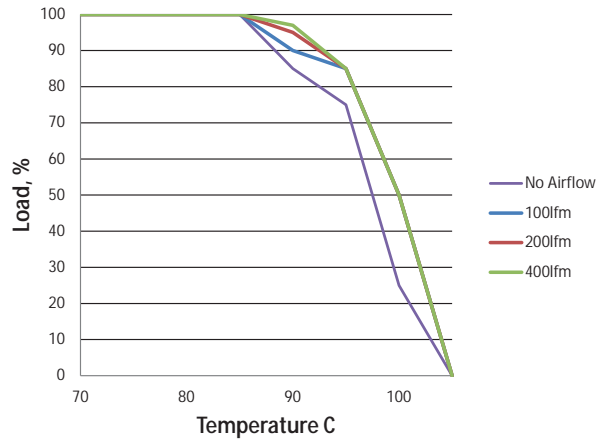

**DERATING GRAPHS**

**MTC2S1203MC - 18Vin**

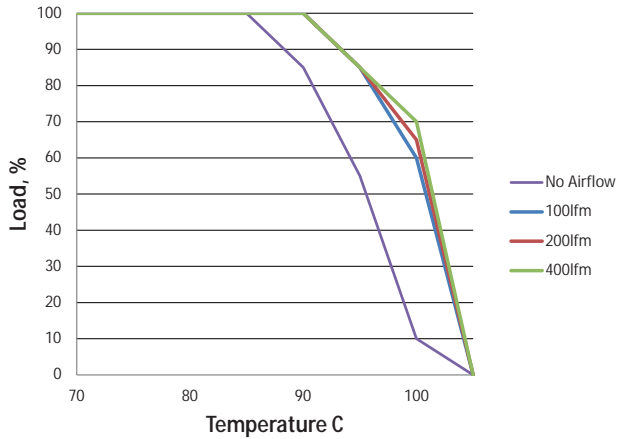

**MTC2S1205MC- 18Vin**

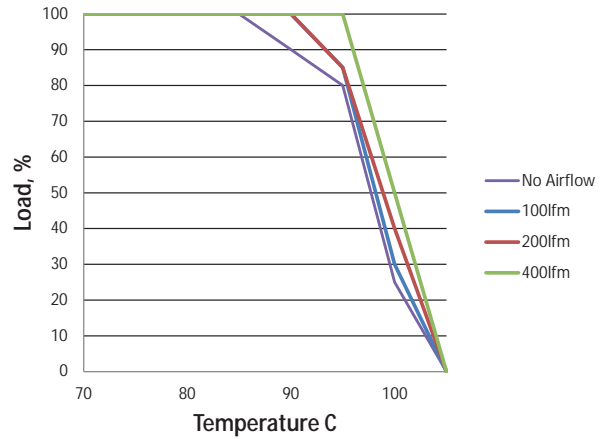

**MTC2S1212MC- 18Vin**

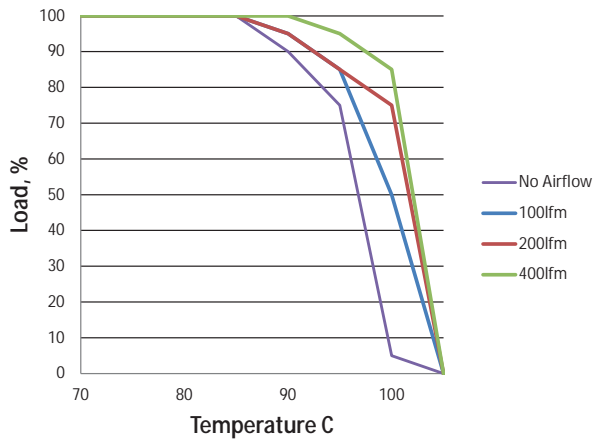

**MTC2S2403MC- 36Vin**

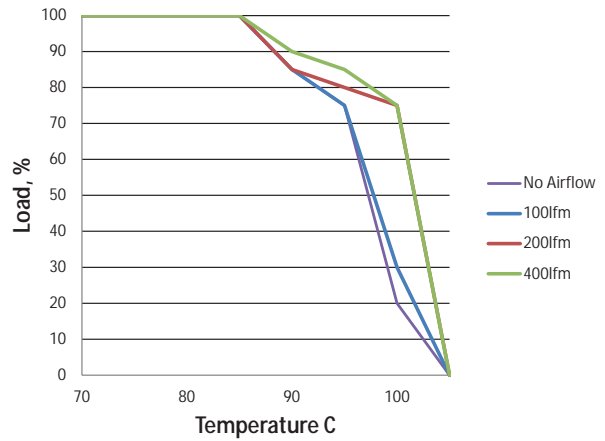

**MTC2S2405MC- 36Vin**

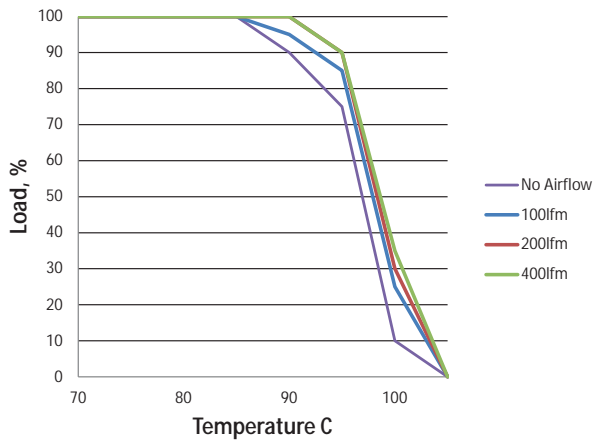

**MTC2S2412MC- 36Vin**

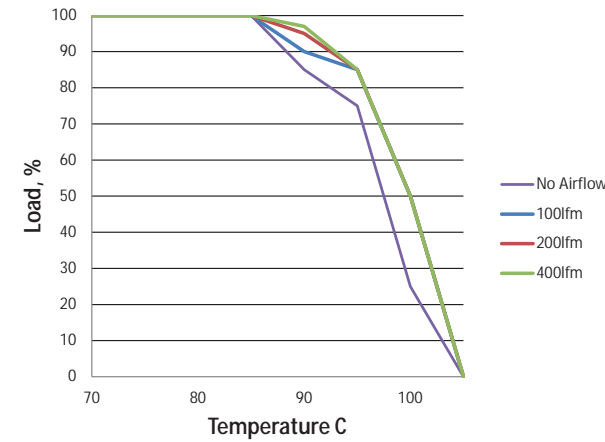

**EMC FILTERING AND SPECTRA**

**FILTERING**

The following table shows the additional input capacitor and input inductor typically required to meet EN 55022 Curve A, Quasi-Peak EMC limit, as shown in the following plots. The following plots show positive and negative quasi peak and CISPR22 Average Limit A (orange line) and Quasi Peak Limit A (blue line) adherence limits.

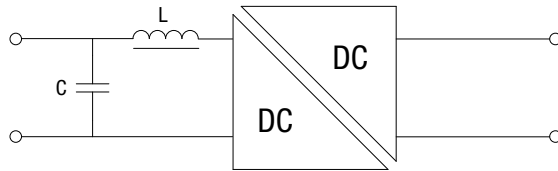

Inductor		Capacitor	
L, $\mu$ H	SMD	Through Hole	C, $\mu$ F
47	24470C	22R473C	10

**MTC2S1203MC**

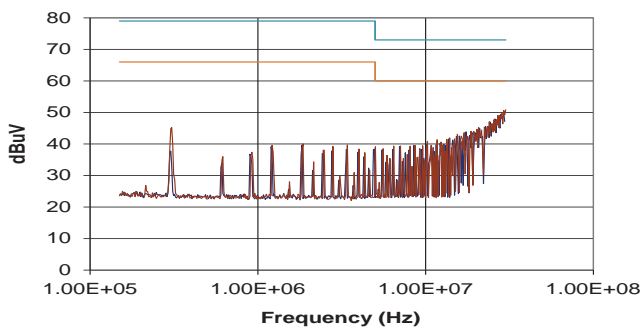

**MTC2S1205MC**

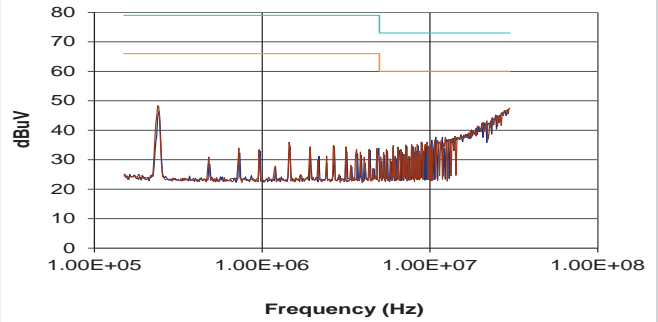

**MTC2S1212MC**

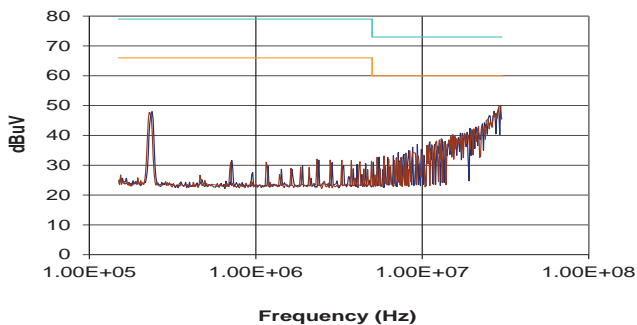

**MTC2S2403MC**

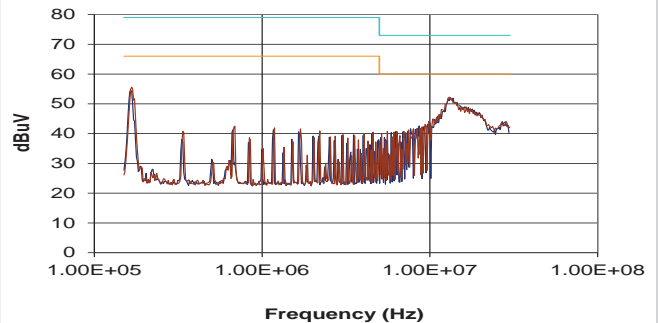

## EMC FILTERING AND SPECTRA

MTC2S2405MC

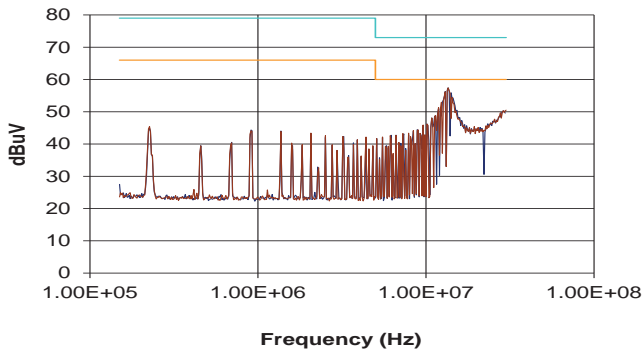

MTC2S2412MC

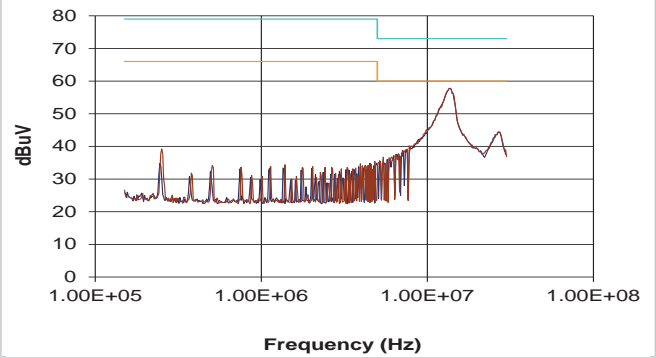

## RoHS COMPLIANCE, MSL AND PSL INFORMATION



This series is compatible with Pb-Free soldering systems and is also backward compatible with Sn/Pb soldering systems. The MTC2 series has a process, moisture, and reflow sensitivity classification of MSL2 PSL R7F as defined in J-STD-020 and J-STD-075. This translates to: MSL2 = 1 year floor life, PSL R7F = Peak reflow temperature 245°C with a limitation on the time above liquidus (217°C) which for this series is 90 sec max. The pin termination finish on this product series is Gold with Nickel Pre-plate.

## PACKAGE SPECIFICATIONS

### Mechanical Dimensions

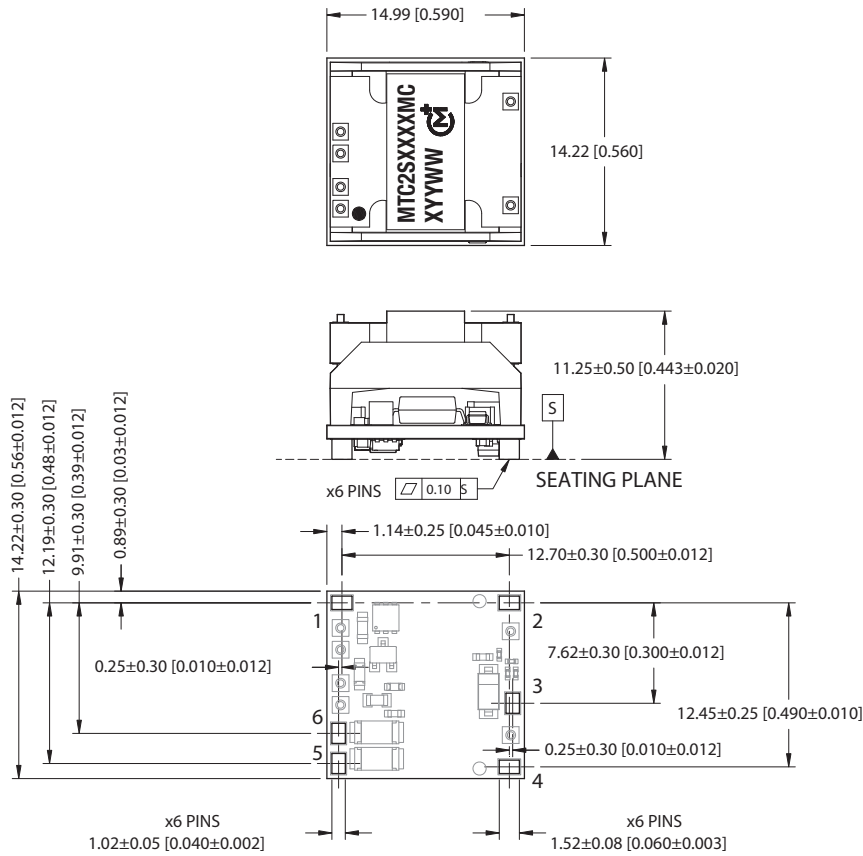

### Pin Connections

Pin	Function
1	+Vin
2	-Vout
3	Trim
4	+Vout
5	Ctrl
6	-Vin

All dimensions in mm (inches), Controlling dimension is mm. Tolerances (unless otherwise stated)  $\pm 0.15(0.006)$ .  
Components shown for reference only.

Weight: 3.52g

### Recommended Footprint Details

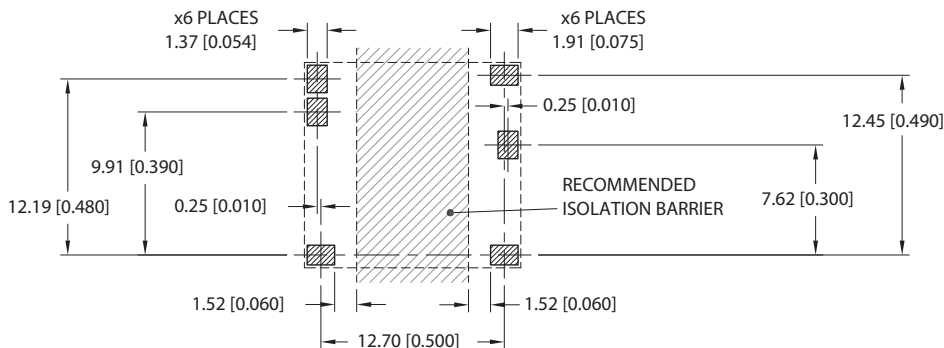

**TAPE & REEL SPECIFICATIONS**

**REEL OUTLINE DIMENSIONS**

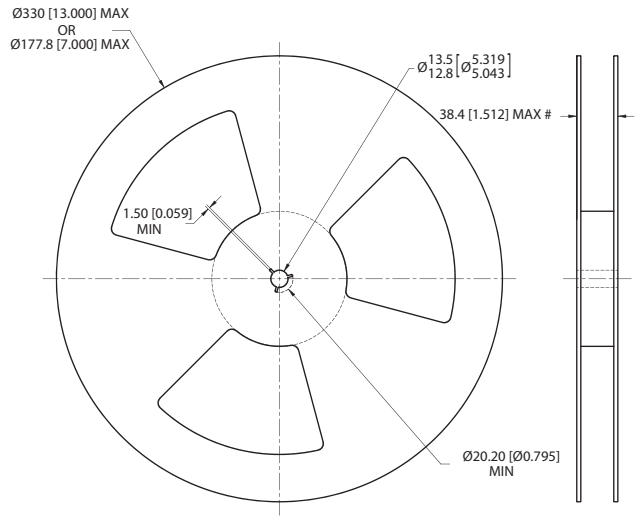

Tape & Reel specifications shall conform with current EIA-481 standard  
 Unless otherwise stated all dimensions in mm(inches)  
 Controlling dimension is mm  
 # Measured at hub

**REEL PACKAGING DETAILS**

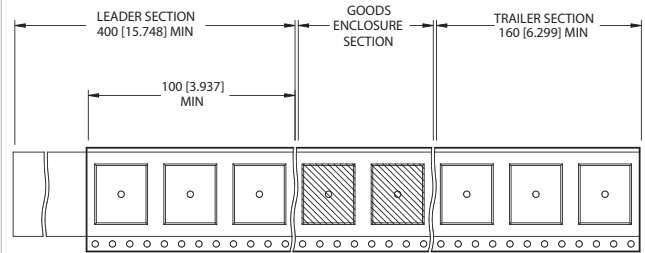

Carrier tape pockets shown are illustrative only - Refer to carrier tape diagram for actual pocket details.

Reel Quantity: 7" - 30 or 13" - 150

**TAPE OUTLINE DIMENSIONS**

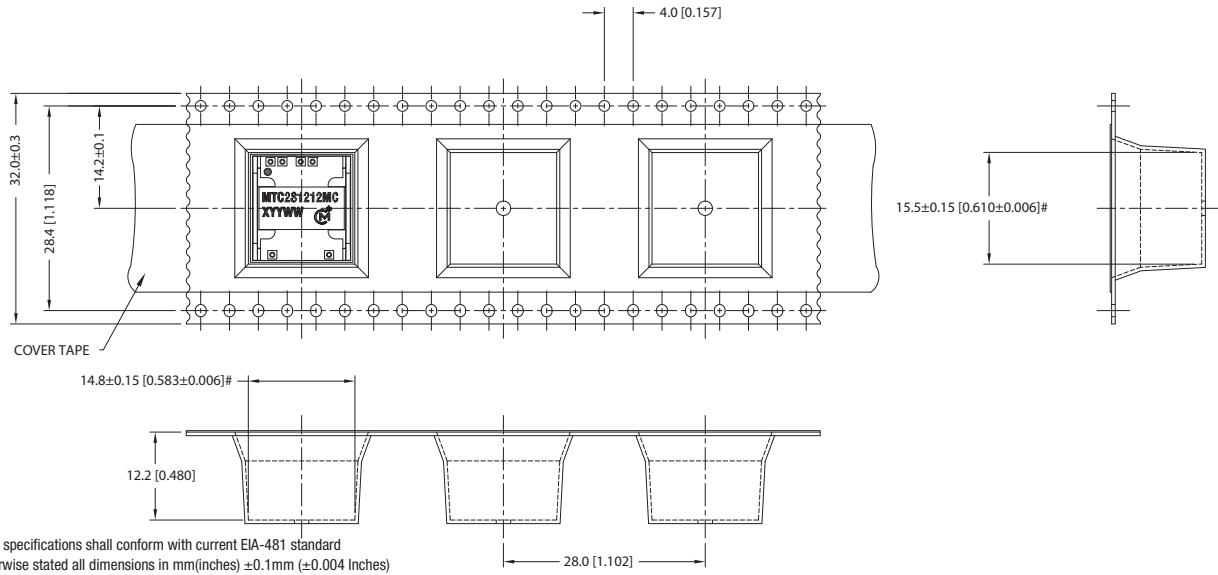

Tape & Reel specifications shall conform with current EIA-481 standard  
 Unless otherwise stated all dimensions in mm(inches) ±0.1mm (±0.004 inches)  
 Controlling dimension is mm  
 Components shall be orientated within the carrier tape as indicated  
 # Measured on a plane 0.3mm above the bottom pocket



This product is subject to the following **operating requirements** and the **Life and Safety Critical Application Sales Policy**:  
 Refer to: <http://www.murata-ps.com/requirements/>

Murata Power Solutions, Inc. makes no representation that the use of its products in the circuits described herein, or the use of other technical information contained herein, will not infringe upon existing or future patent rights. The descriptions contained herein do not imply the granting of licenses to make, use, or sell equipment constructed in accordance therewith. Specifications are subject to change without notice.  
 © 2017 Murata Power Solutions, Inc.