



### FEATURES

- IEC60601 Ed.3 medical (2 x MOPP Pri-Sec)  
EN60950 ITE safety approved
- 250W compact high density
- 3" x 5" standard footprint
- High efficiency up to 94%
- Remote sense
- Remote On/Off, Power OK (MVAC250-xxAFx)
- Universal AC input with active PFC
- Less than 1U high – 1.4"
- Convection cooled operation up to 170W
- Isolated 12V@1A fan output
- Isolated 5V@2A standby/auxiliary output with models MVAC250-xxAFx
- RoHS compliant
- Active inrush protection
- Current sharing option

### DESCRIPTION

The MVAC250 series switching power supplies utilize advanced component and circuit technologies to deliver high efficiency. Designed for medical, computing, communications, telecom and other OEM applications to satisfy 1U height design considerations, the MVAC250 Series measures only 3.0" x 5.0" x 1.40". All models offer universal AC input with active power factor correction (PFC) and compliance to worldwide safety and EMC standards.



Available now at  
[www.murata-ps.com/en/3d/acdc.html](http://www.murata-ps.com/en/3d/acdc.html)

### ORDERING GUIDE

Model Number	Natural Convection Cooling	Forced Air Cooling	Main Output (V1)	Fan Output (V2)	Aux Output (V3)
MVAC250-12F	170W	250W @ 250LFM	12V	12V	
MVAC250-24F			24V	12V	
MVAC250-48F			50V	12V	
MVAC250-12AF			12V	12V	5V
MVAC250-12AFD*			12V	12V	5V
MVAC250-24AFD*			24V	12V	5V
MVAC250-48AFD*			50V	12V	5V
MVAC250-24AFT*			24V	12V	5V
MVAC-COVER	Optional cover kit assembly; see MVAC-COVER datasheet for details				

\* Refer to page 2 for current sharing model number MVAC250-xxAFD notes.

\* CCC Certification is not available for these models.

### INPUT CHARACTERISTICS

Parameter	Conditions	Min.	Typ.	Max.	Units
Input Voltage Operating Range	Single phase	90	115/230	264	Vac
	DC	127		300	Vdc
Input Frequency		47	50/60	63	Hz
Turn-on Input Voltage	Input rising	80		90	Vac
Turn-off Input Voltage	Input falling	70		80	
Input Current	90Vac input, full load all outputs			3.4	A
No Load Input Power (MVAC250-xxAFD)*	(PS_ON = OFF, 5V_Aux = 0A)	1.5		2.0	W
Inrush Current	At 264Vac, at 25°C cold start		15		Apk
Power Factor	At 230Vac, full load		0.96		

### OUTPUT CHARACTERISTICS

Model Number	Main Output Voltage (V1)	Load Current	Maximum Load Capacitance	Line, Load, Cross Regulation	Typical Efficiency @230Vac
MVAC250-12F	12V	0.4 to 20.8A	0 to 1500µF	± 1%	93%
MVAC250-24F MVAC250-24AFT	24V	0.2 to 10.4A	0 to 300µF	± 1%	93%
MVAC250-48F	50V	0.1 to 5.0A	0 to 82µF	± 1%	94%
MVAC250-12AF	12V	0 to 20.8A	0 to 1500µF	± 1%	93%
MVAC250-12AFD	12V @ 10.4A <sup>6</sup>	0 to 20.8A	0 to 1500µF	± 1.5% <sup>6</sup>	93%
MVAC250-24AFD	24V @ 5.2A <sup>6</sup>	0 to 10.4A	0 to 300µF	± 1.5% <sup>6</sup>	93%
MVAC250-48AFD	50V @ 2.5A <sup>6</sup>	0 to 5.0A	0 to 68µF	+3.0% / -1.5% <sup>6</sup>	94%

### Main Output Characteristics (all models)

Parameter	Conditions	Typ.	Max.	Units
Transient Response <sup>9</sup>	50% load step, 1A/µsec slew rate		± 5	%
Settling Time to 1% of Nominal			500	µsec
Turn On Delay	After application of input power		3	sec
Output Voltage Rise	Monotonic <sup>5</sup>		50	msec
Output Holdup	120Vac/60Hz, full load	20		
Temperature Coefficient			0.02	%/°C
Ripple Voltage & Noise <sup>1</sup>			1	%
Remote Sense	Compensates for up to 0.5V of lead drop with remote sense connected. Protected against short circuit and reverse connection.		500	mV

### Auxiliary Output Characteristics (varies by model)

Auxiliary Output	Aux Output Voltage <sup>8</sup>	Load Current	Load Capacitance	Line, Load, Cross Regulation <sup>3</sup>	Ripple Voltage & Noise <sup>1</sup>
Fan (V2) all models	12V	0 to 1A	0 to 220µF	± 10%	2%
Aux (V3) – MVAC250-xxAFx	5V	0 to 2A	0 to 220µF	± 5%	1%



### ENVIRONMENTAL CHARACTERISTICS

Parameter	Conditions	Min.	Typ.	Max.	Units
Storage Temperature Range		-40		85	°C
Operating Temperature Range	See power rating curves	-10		70	
Operating Humidity	Non-condensing	10		95	%
Operating Altitude		-200		5000	m
MTBF	Telcordia SR-332 M1C3 @25°C	474K			Hours
Shock	Operating, MIL-HBK-810E	Complies			
	Non-operating, MIL-HBK-810E	Complies			
Operational Vibration	IEC-68-2-27 standard	Complies to levels of IEC721-3-2			
Safety – Medical Standards 2 x MOPP (Primary-Secondary)	IEC60601-1 (Ed. 3) – CB Cert & Report ANSI/AAMI ES60601-1 (2005+ C1:2005+A2:10) CAN/CSA 22.2 No. 60601-1 (2008) 3rd Edition EN60601-1:2006+CORR:2010				
Safety – ITE Standards	UL60950-1; 2nd Edition, 2011-12-19 CSA22.2 No..60950-1-07, 2nd Edition, 2001-12. EN60950-1:2006+A11:2009/A1/2010/A12:2011 IEC 60950 (ed.2), IEC60950 (ed.2);am1 CE Marking per LVD				
Warranty	2 years				
Outside Dimensions	3.0" x 5.0" x 1.4" (76.2mm x 127mm x 35.6mm)				
Weight	MVAC250-xxF: 0.73 lbs (332.9g); MVAC250-xxAFD: 0.76 lbs (344.7g); MVAC250-xxAFT 0.78 lbs (352.7g)				

### RESIDUAL RISK (PER ISO 14971 & IEC60601-1) FOR USER CONSIDERATION

Fault Condition	Residual Risk
Complies	Contact your Murata salesperson for details

### PROTECTION CHARACTERISTICS

Parameter	Conditions	Min.	Typ.	Max.	Units
Over Voltage Protection <sup>4</sup>	V1 (main output) latching	110		125	%
	V3 (aux output: MVAC250-xxAFx) latching	5.5		7.5	V
Over Current Protection <sup>4</sup>	V1, hiccup mode	110		130	%Amax
Over Temperature Protection	Auto-recovery		Complies		
Remote Sense Short Circuit Protection			Complies		
Remote Sense Reverse Connection Protection			Complies		

### ISOLATION CHARACTERISTICS

Parameter	Conditions	Min.	Typ.	Max.	Units
Isolation	Primary to Chassis	1500			Vac
	Primary to Secondary (2xMOPP)	4000			
	Secondary to Chassis	500			
	Output to Output	500			
Earth Leakage Current (under single fault condition): 264Vac, 60Hz, 25°C	MVAC250-xxAFD		300		µA
	MVAC250-xxAF; -xxAFT		300		
	MVAC250-xxF		350		
Earth Leakage Current (under normal conditions): 264Vac, 60Hz, 25°C	MVAC250-xxAFD		150		µA
	MVAC250-xxAF; -xxAFT		150		
	MVAC250-xxF		250		

### CURRENT SHARING OPTION – MVAC250-xxAFD ONLY

Model Number	Description
MVAC250-12AFD	Main Output: Current share is achieved using the droop method. Nominal output voltage is achieved at 50% load and output voltage increases/drops at a rate of: <ul style="list-style-type: none"> <li>• 48mV per amp for 12V output</li> <li>• 192mV per amp for 24V output</li> <li>• 800mV per amp for 50V output.</li> </ul>
MVAC250-24AFD	Startup of parallel power supplies is not internally synchronized. If more than 250W combined power is needed, start-up synchronization must be provided by using a common PS_ON signal. To account for ±10% full load current sharing accuracy and the reduction in full load output voltage due to droop, available output power must be derated by 15% when units are operated in parallel. Current sharing can be achieved with or without remote sense connected to the common load. If ORing protection is desired, please contact Murata sales for external ORing FET board or external ORing FET reference circuit design.
MVAC250-48AFD	
	Aux (V3) output can be tied together for redundancy but total combined output power must not exceed 10W, external ORing devices must be used.
	Fan (V2) can be tied together for redundancy but total combined output power must not exceed 12W, external ORing diodes can be used.

EMISSIONS AND IMMUNITY		
Characteristic	Standard	Compliance
Input Current Harmonics	IEC/EN 61000-3-2	Class A
Voltage Fluctuation and Flicker	IEC/EN 61000-3-3	Complies
Conducted Emissions	EN 55022	Class B
	FCC Part 15	Class B
ESD Immunity	IEC/EN 61000-4-2	Level 4, Criterion 2
Radiated Field Immunity	IEC/EN 61000-4-3	Level 3, Criterion A
Electrical Fast Transient Immunity	IEC/EN 61000-4-4	Level 4, Criterion A
Surge Immunity	IEC/EN 61000-4-5	Level 3, Criterion A
Radiated Field Conducted Immunity	IEC/EN 61000-4-6	Level 3, 10V/m, Criterion A
Magnetic Field Immunity	IEC/EN 61000-4-8	Level 3, Criterion A
Voltage dips, interruptions	IEC/EN 61000-4-11	Level 3, Criterion B

**EMI CONSIDERATIONS**

For optimum EMI performance, the power supply should be mounted to a metal plate grounded to all 4 mounting holes of the power supply. To comply with safety standards, this plate must be properly grounded to protective earth (see mechanical dimension notes). Pre-compliance testing has shown the stand-alone power supply to comply with EN55022 Class A radiated emissions. Class B radiated emissions are achievable with a metal enclosure. Radiated emission results vary with system enclosure and cable routing paths.

**SAFETY CONSIDERATIONS**



1. This power supply is a component level power supply intended for use in Class I or Class II applications. Secondary ground traces need to be suitably isolated from primary ground traces when used in Class II applications.
2. When the power supply is used in Class II equipment, all ground traces and components connected to the primary side are considered primary for spacing and insulation considerations.

**STATUS AND CONTROL SIGNALS – MVAC250-xxAFD ONLY**

Parameter	Models	Conditions
PS_ON	All models except as noted below.	This signal must be pulled low (sink current >2mA) to +5V_AUX_RTN to turn on the main and Fan (V2) output. The +5V_AUX output is independent of the PS_ON signal and comes up automatically when the input AC or input DC voltage is applied within their specified operating ranges.
	MVAC250-xxAFD	This pin is pulled high internally and so all three outputs (main, Fan output and +5V_AUX) come up automatically when the input AC or input DC voltage is applied within their specified operating ranges. Pulling this pin low (sink current >2mA) to +5V_AUX_RTN will disable the main and fan outputs.
PWR_OK	All models	Open collector logic goes high 50-200 msec after main output is in regulation; it goes low at least 6 msec before loss of regulation. Internal 10K pull up to +5V_AUX is provided. Applications using PWR_OK signal should maintain a minimum load of 5W on the main or fan output.

1. Noise and ripple is measured at an oscilloscope jack on the output, 20MHz bandwidth, and with 0.1µF ceramic and 10µF aluminum electrolytic capacitors across the output pins.
2. Unless otherwise specified all measurements are taken at 120Vac input and 25°C ambient temperature.
3. Fan (V2) regulation band applies from 0.1A to 1A load with a minimum of 10W load on the main (V1) output.
4. Fan (V2) has overvoltage protection (tracking V1) and short circuit protection. Overloading the Fan (V2) output can result in permanent damage to the unit.
5. 24V and 50V models may exhibit up to 5% turn on overshoot for loads less than 4% of full load.
6. See current sharing option section for droop characteristics.
7. No load Input power varies by model and by input line. Measurement is difficult to make due to burst mode operation. Please contact Murata sales if additional information is required.
8. All three output returns are isolated from each other (see isolation characteristics section); the returns may be tied together externally.
9. Load steps beginning from combined loads on the main and fan outputs of less than 5W may result in transient undershoots outside of the spec limits.

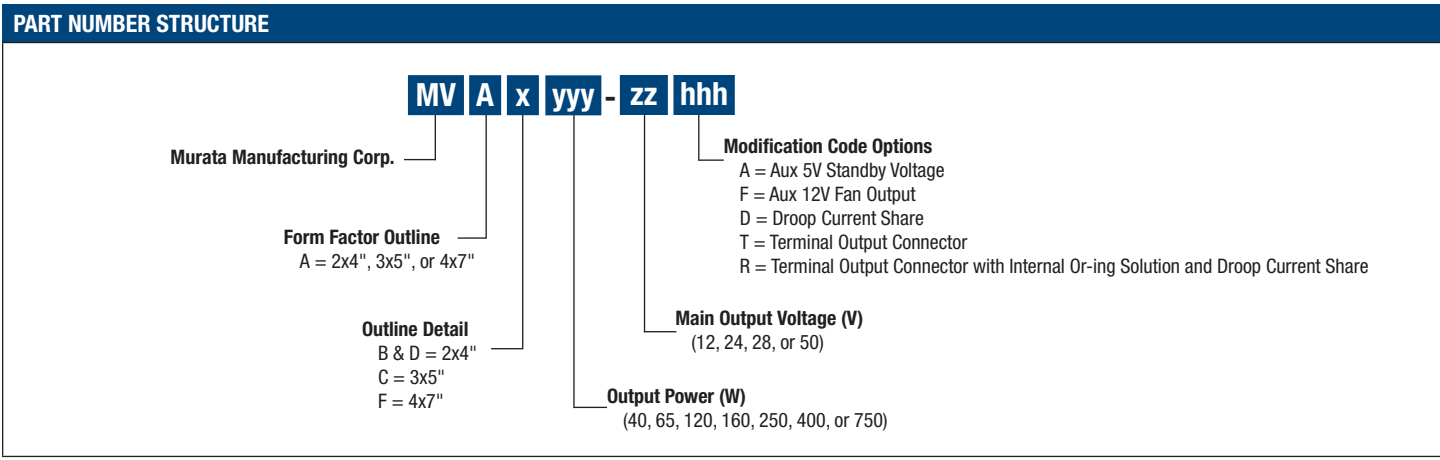

**PERFORMANCE DATA**

MVAC250-12F Efficiency

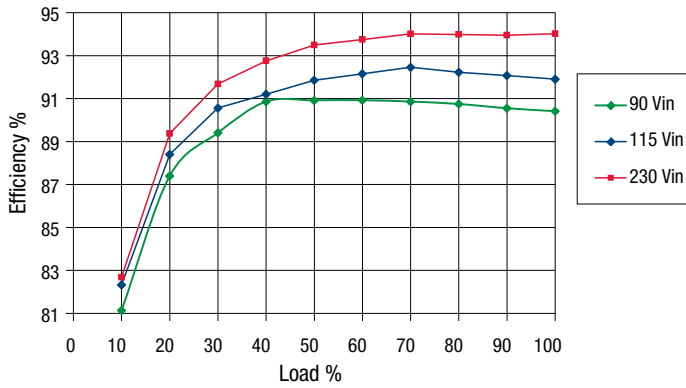

MVAC250-24F Efficiency

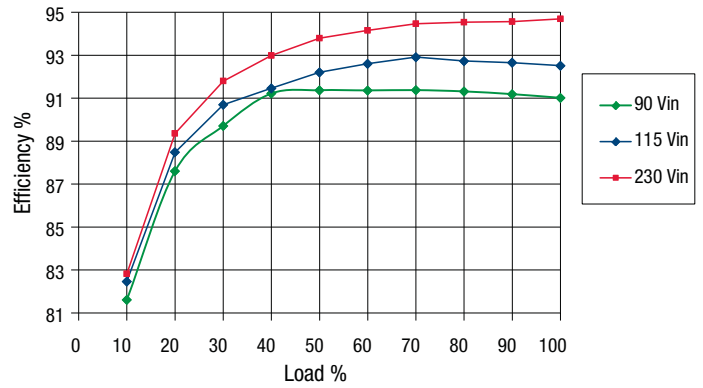

MVAC250-48F Efficiency

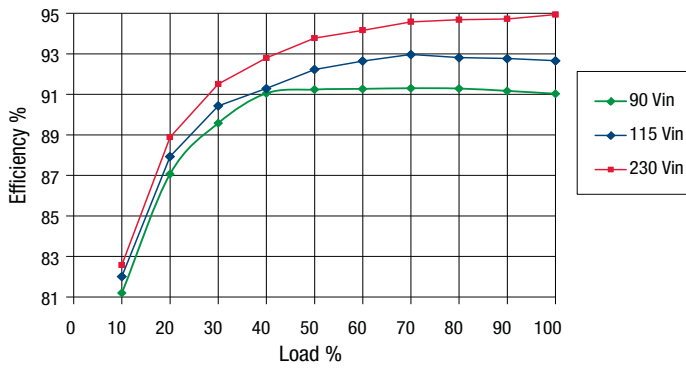

Inrush Current



Time: 100 msec/div, Ch1: 500 V/div, Ch4: 20 A/div, Vin: 264 VAC, I<sub>pk</sub> = 15.1 A AC applied at peak of sine wave

**THERMAL CONSIDERATIONS**

System thermal management is critical to the performance and reliability of the MVAC series power supplies. Performance derating curves are provided which can be used as a guideline for what can be achieved in a system configuration with controlled airflow at various input voltage conditions.

The air flow curves are generated using an AMCA 210-99 and ASHRAE 51-1999 compliant wind tunnel with heated inlet air and a controlled CFM providing a duct test section having a calculated average LFM. A correlation between the test setup and the actual system environment is paramount to understanding what can be achieved in an actual system. In a power supply of this density, cooling air moving both through the unit as well as around the unit strongly influences local temperatures. The wind tunnel test setup was constructed to produce a flow with a slight back pressure to induce both flow conditions by providing a small gap between the power supply and duct walls of 0.5" (13mm). The optimal and characterized airflow direction is from the input connector to the output connector (see diagram below). The P-Q flow curve for this test setup is also shown below.

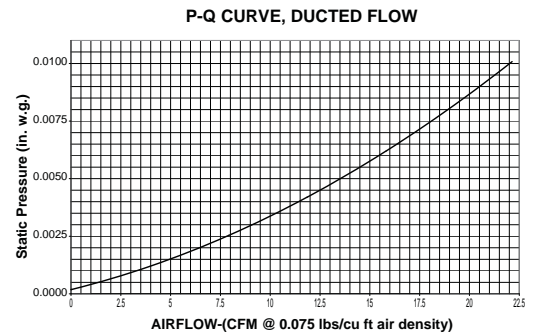
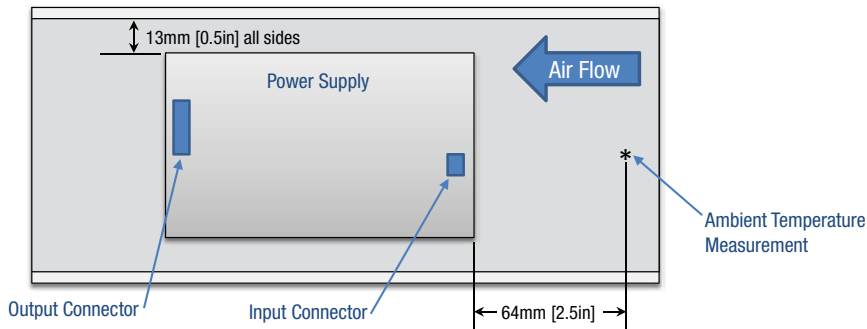

The natural convection data is obtained from a horizontally mounted power supply with un-obstructed flow at room temperature. At elevated temperature the power supply data is taken while it is surrounded by a large vented enclosure to minimize forced cross flows inherent in the elevated temperature test system.

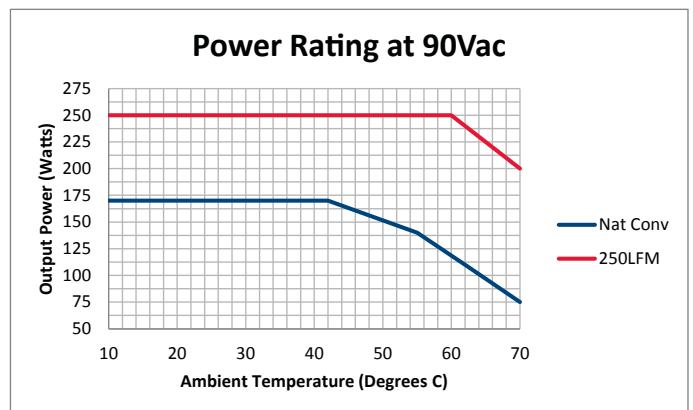
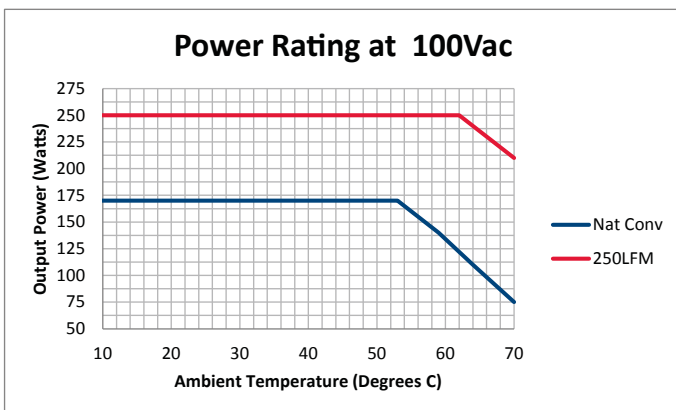
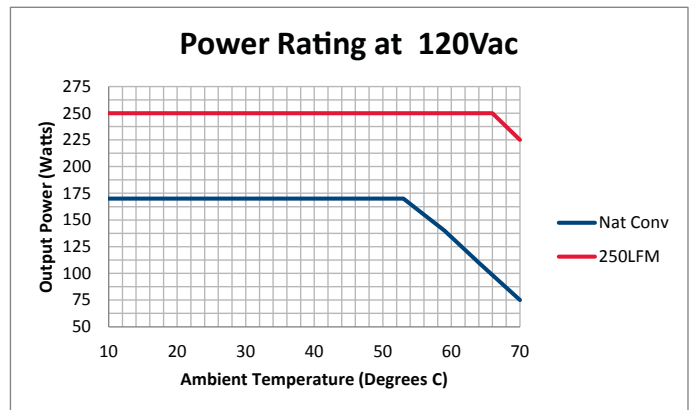
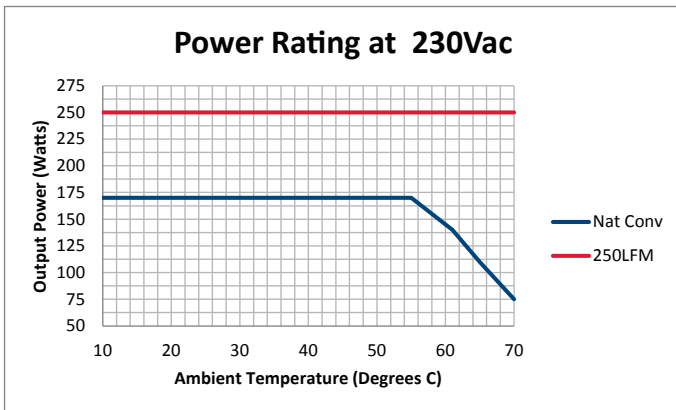

**WIRING DIAGRAM FOR OUTPUT**

Dotted lines show optional remote sense connections.  
Optional remote sense lines can be attached to a load that is a distance away from the power supply to improve regulation at the load.

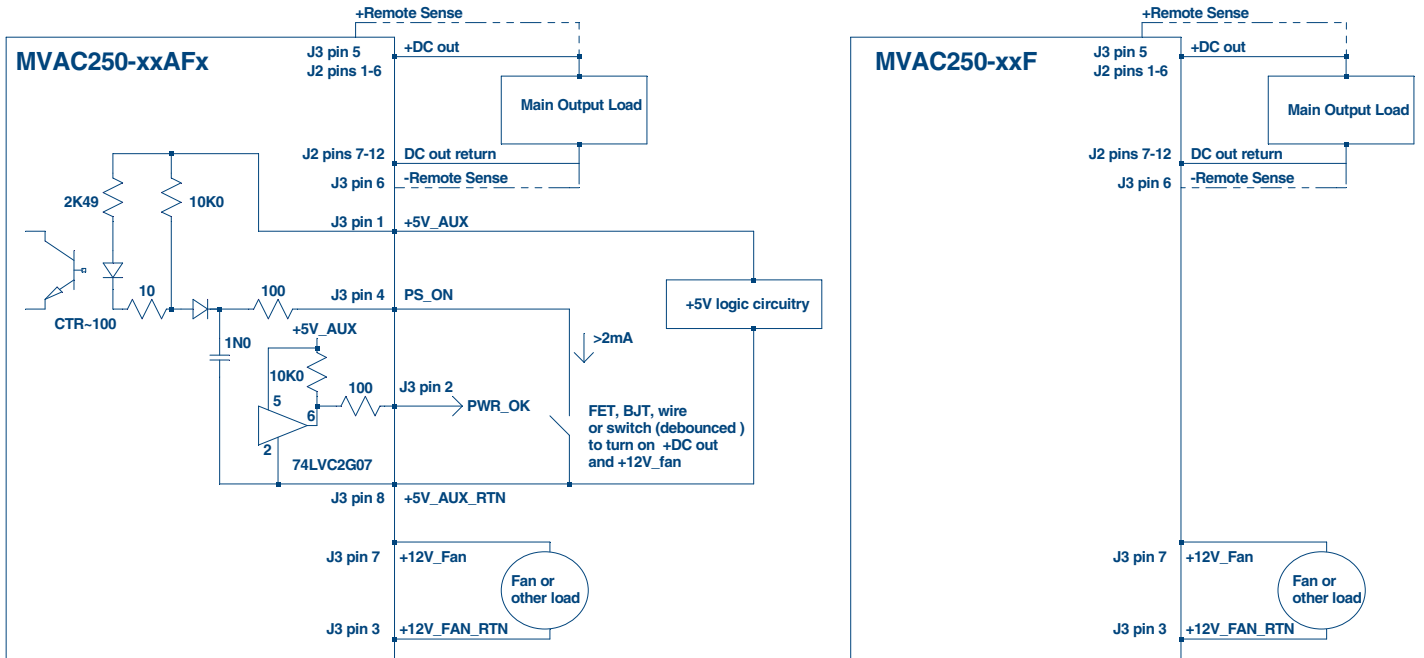

**APPLICATION NOTE**

Document Number	Description	Link
ACAN-42 MVAC Series	External ORing FET Reference Circuit	<a href="http://www.murata-ps.com/data/apnotes/acan-42.pdf">www.murata-ps.com/data/apnotes/acan-42.pdf</a>

### MECHANICAL DIMENSIONS – MVAC250-xxF ONLY

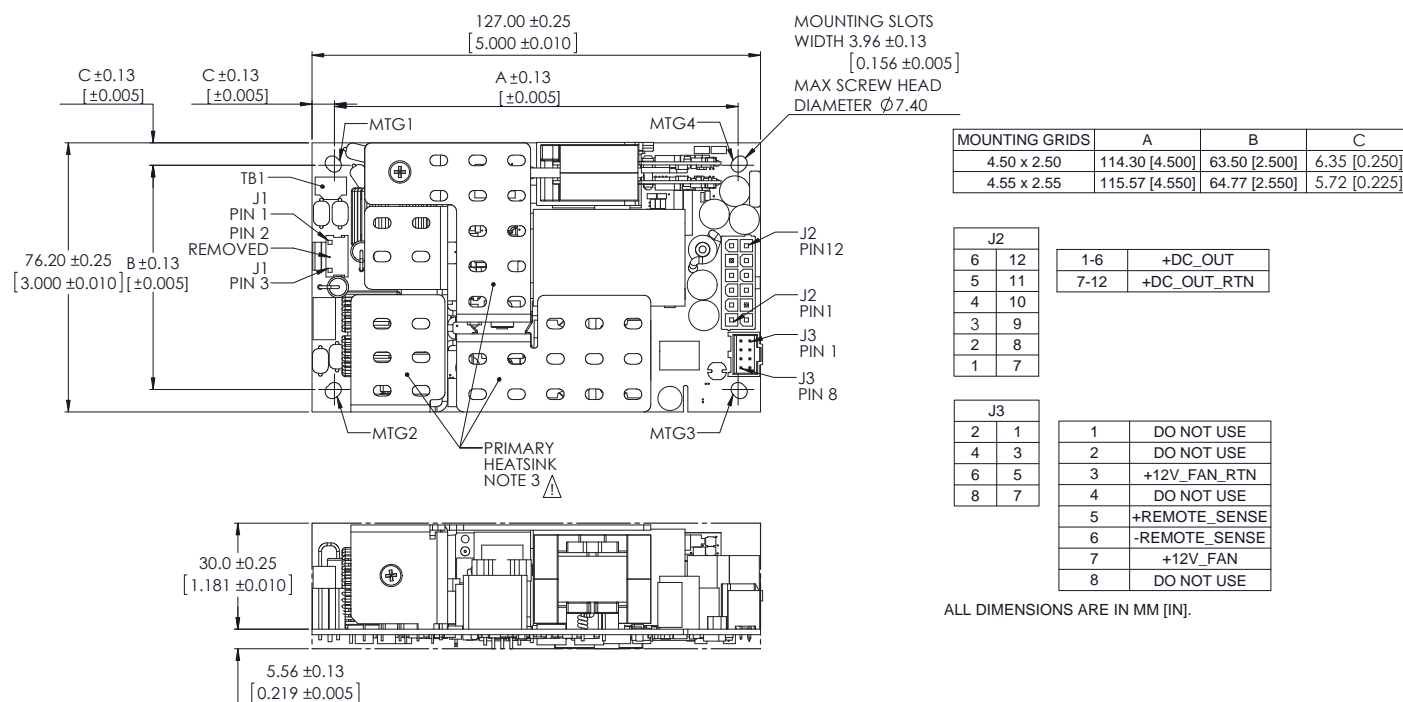

#### SAFETY CONSIDERATION NOTES:



- Protective bonding conductor from the end product protective earthing terminal must be tied to TB1. For optimum EMI performance, while maintaining Class I safety isolation all 4 mounting holes must be tied to the end product protective earthing terminal. To maintain Class II safety isolation mounting holes MTG1 and MTG2 need to be isolated from protective earth and should use standoffs of non-conductive material.
- This power supply requires mounting standoffs of minimum 6mm in height. If there is risk of chassis deformation or shorter standoff height is required, an appropriate insulator must be used under the power supply with adequate extension beyond the outline of the power supply. In all cases, the applicable safety standards must be applied to ensure proper creepage and clearance requirements are met.
- The primary heatsink is considered a live primary circuit, and should not be touched. It is recommended that the primary heatsink be kept at least 3.5mm from chassis and 7mm from secondary circuits. In all cases, the applicable safety standards must be applied to ensure proper creepage and clearance requirements are met.
- This product is subject to the following operating requirements and the Life and Safety Critical Application Sales Policy: Refer to: <http://www.murata-ps.com/requirements/>
- Used only in non-tropical conditions.
- Double pole/neutral fusing.

Dimensions: 3.0" x 5.0" x 1.4" (76.2mm x 127mm x 35.6mm)

### INPUT/OUTPUT CONNECTOR AND SIGNAL SPECIFICATION AND MATING CONNECTORS – MVAC250-xxF ONLY

Connector	PIN	Description	Mating Housing	Crimp terminal/pins
Input Connector J1 : Molex 26-62-4030	1	AC Neutral	Molex 0009930300	Molex 0008500105 (18-24 AWG)
	3	AC Line		Molex 0008500107 (22-26 AWG)
Output Connector J2 : Molex 39-28-1123	1,2,3,4,5,6	+DC_OUT	Molex 0039012125	Molex 0039000038
	7,8,9,10,11,12	+DC_OUT_RTN		
Output Connector J3: Molex 90130-1108	1	DO NOT USE	Molex 0901420008	Molex 0901190109
	2	DO NOT USE		
	3	+12V_FAN_RTN		
	4	DO NOT USE		
	5	+ Remote Sense		
	6	- Remote Sense		
	7	+12V_FAN		
	8	DO NOT USE		

### MECHANICAL DIMENSIONS – MVAC250-xxAF & MVAC250-xxAFD

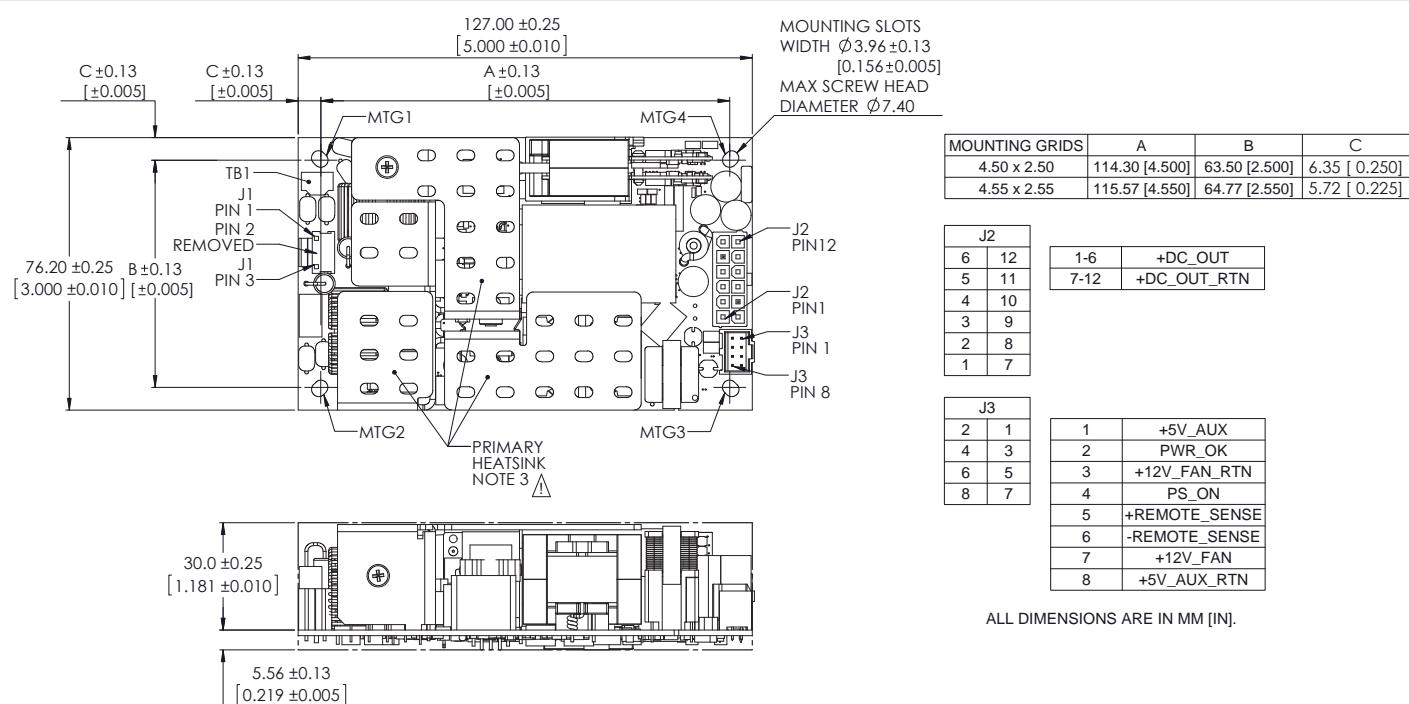

#### SAFETY CONSIDERATION NOTES:

- Protective bonding conductor from the end product protective earthing terminal must be tied to TB1. For optimum EMI performance, while maintaining Class I safety isolation all 4 mounting holes must be tied to the end product protective earthing terminal. To maintain Class II safety isolation mounting holes MTG1 and MTG2 need to be isolated from protective earth and should use standoffs of non-conductive material.
- This power supply requires mounting standoffs of minimum 6mm in height. If there is risk of chassis deformation or shorter standoff height is required, an appropriate insulator must be used under the power supply with adequate extension beyond the outline of the power supply. In all cases, the applicable safety standards must be applied to ensure proper creepage and clearance requirements are met.
- The primary heatsink is considered a live primary circuit, and should not be touched. It is recommended that the primary heatsink be kept at least 3.5mm from chassis and 7mm from secondary circuits. In all cases, the applicable safety standards must be applied to ensure proper creepage and clearance requirements are met.
- This product is subject to the following operating requirements and the Life and Safety Critical Application Sales Policy: Refer to: <http://www.murata-ps.com/requirements/>
- Used only in non-tropical conditions
- Double pole/neutral fusing.



Dimensions: 3.0" x 5.0" x 1.4" (76.2mm x 127mm x 35.6mm)

### INPUT/OUTPUT CONNECTOR AND SIGNAL SPECIFICATION AND MATING CONNECTORS – MVAC250-xxAF AND MVAC250-xxAFD MODELS

Connector	PIN	Description	Mating Housing	Crimp terminal/pins
Input Connector J1: Molex 26-62-4030	1	AC Neutral	Molex 0009930300	Molex 0008500105 (18-24 AWG) Molex 0008500107 (22-26 AWG)
	3	AC Line		
Output Connector J2: Molex 39-28-1123	1,2,3,4,5,6	+DC_OUT	Molex 0039012125	Molex 0039000038
	7,8,9,10,11,12	+DC_OUT_RTN		
Output Connector J3: Molex 90130-1108	1	+5V_AUX	Molex 0901420008	Molex 0901190109
	2	PWR_OK		
	3	+12V_FAN_RTN		
	4	PS_ON		
	5	+ Remote Sense		
	6	- Remote Sense		
	7	+12V_FAN		
	8	+5V_AUX_RTN		



### MECHANICAL DIMENSIONS – MVAC250-xxAFT

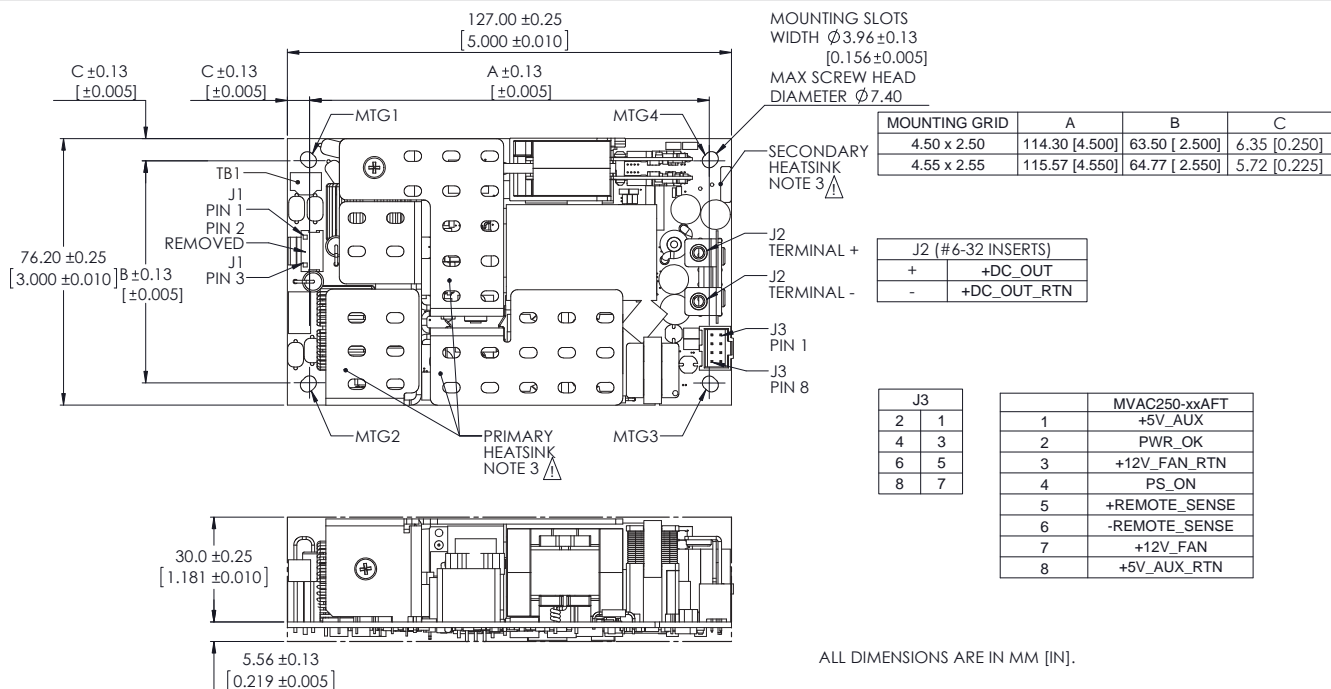

#### SAFETY CONSIDERATION NOTES:

- Protective bonding conductor from the end product protective earthing terminal must be tied to TB1. For optimum EMI performance, while maintaining Class I safety isolation all 4 mounting holes must be tied to the end product protective earthing terminal. To maintain Class II safety isolation mounting holes MTG1 and MTG2 need to be isolated from protective earth and should use standoffs of non-conductive material.
- This power supply requires mounting standoffs of minimum 6mm in height. If there is risk of chassis deformation or shorter standoff height is required, an appropriate insulator must be used under the power supply with adequate extension beyond the outline of the power supply. In all cases, the applicable safety standards must be applied to ensure proper creepage and clearance requirements are met.
- The primary heatsink is considered a live primary circuit, and should not be touched. It is recommended that the primary heatsink be kept at least 3.5mm from chassis and 7mm from secondary circuits. In all cases, the applicable safety standards must be applied to ensure proper creepage and clearance requirements are met.
- This product is subject to the following operating requirements and the Life and Safety Critical Application Sales Policy: Refer to: <http://www.murata-ps.com/requirements/>
- Used only in non-tropical conditions
- Double pole/neutral fusing.

Dimensions: 3.0" x 5.0" x 1.4" (76.2mm x 127mm x 35.6mm)

### INPUT/OUTPUT CONNECTOR AND SIGNAL SPECIFICATION AND MATING CONNECTORS – MVAC250-xxAFT

Connector	Pin	Description	Mating Housing	Crimp Terminal/Pins
Input Connector J1: Molex 26-62-4030	1	AC Neutral	Molex 0009930300	Molex 0008500105 (18-24 AWG) Molex 0008500107 (22-26 AWG)
	3	AC Line		
Output Connector J2	+	+DC_OUT	Molex 0901420008	Molex 0901190109
	-	+DC_OUT_RTN		
Output Connector J3: Molex 90130-1108	1	+5V_AUX	Molex 0901420008	Molex 0901190109
	2	PWR_OK		
	3	+12V_FAN_RTN		
	4	PS_ON		
	5	+ Remote Sense		
	6	- Remote Sense		
	7	+12V_FAN		
	8	+5V_AUX_RTN		

Murata Power Solutions, Inc.  
11 Cabot Boulevard, Mansfield, MA 02048-1151 U.S.A.  
ISO 9001 and 14001 REGISTERED



**This product is subject to the following operating requirements and the Life and Safety Critical Application Sales Policy. Refer to: <http://www.murata-ps.com/requirements/>**

Murata Power Solutions, Inc. ("Murata") makes no representation that the use of its products in the circuits described herein, or the use of other technical information contained herein, will not infringe upon existing or future patent rights. The descriptions contained herein do not imply the granting of licenses to make, use, or sell equipment constructed in accordance therewith. Buyer represents and agrees that it has all the necessary expertise to create and implement safeguards that anticipate dangerous consequences of failures, monitor failures and their consequences, lessen the likelihood of failures that might cause harm, and take appropriate remedial actions. Buyer will fully indemnify Murata, its affiliated companies, and its representatives against any damages arising out of the use of any Murata products in safety-critical applications. Specifications are subject to change without notice. © 2014 Murata Power Solutions, Inc.