

# G3VM-□MT

MOS FET Relay Module

## 1 pA max. leakage current\* contributes to high device reliability

- Equipped with a T-switch function to achieve fA-level minimal leakage current and contributes to measurement performance equivalent to conventional reed relays
- Contact form: 1a (SPST-NO) + T-switch function
- Contributes to reduction of the mounting space on the printed circuit board with a small package

\*  $V_{OFF} = 20\text{ V}, 50\text{ V}, 80\text{ V}$

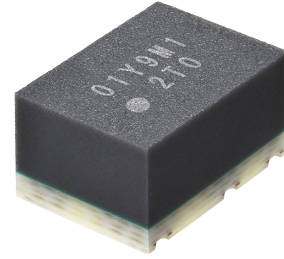

### Application Example

- Semiconductor test equipment

### Package

(Unit: mm)

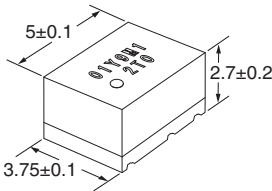

### Model Number Legend

G3VM-□□□□  
1 2 3 4

#### 1. Load voltage

2: 20 V  
6: 60 V  
10: 100 V

#### 2. Contact form

1: 1a (SPST-NO)

Note: See Device Function Modes on page 5.

#### 3. Package

M: MOSFET Relay Module

#### 4. Special function

T: T switch function

### Ordering Information

Package	Contact form	Terminals	Load voltage (peak value) *	Continuous load current (peak value) *		Tape cut packaging		Tape packaging	
				Main	Sub	Model	Minimum package quantity	Model	Minimum package quantity
Module	1a (SPST-NO)	Surface-mounting Terminals	20 V	200 mA		G3VM-21MT	1 pc.	G3VM-21MT (TR01)	100 pcs.
			60 V	800 mA	400 mA	G3VM-61MT		G3VM-61MT (TR01)	
			100 V	550 mA		G3VM-101MT		G3VM-101MT (TR01)	

Note: 1. To order tape packaging for relays with surface-mounting terminals, add "(TR01)" to the end of the model number.

Tape-cut packaging is packaged without humidity resistance. Use manual soldering to mount them.

Note: 2. 500 pcs./reel packing is also available. Please contact your OMRON sales representative.

\* The AC peak and DC values are given for the load voltage and continuous load current.

### Absolute Maximum Rating ( $T_a = 25^\circ\text{C}$ )

Item	Symbol	G3VM-21MT	G3VM-61MT	G3VM-101MT	Unit	Measurement conditions	
Input	LED forward current for main control	$I_{F\text{ Main}}$	30		mA		
	LED forward current for sub control	$I_{F\text{ Sub}}$	30		mA		
	LED forward current reduction rate	$\Delta I_{F/^\circ\text{C}}$	-0.3		$\text{mA}/^\circ\text{C}$	$T_a \geq 25^\circ\text{C}$	
	LED reverse voltage	$V_R$	5		V		
	Junction temperature	$T_j$	125		$^\circ\text{C}$		
Output	Load voltage (AC peak/DC)	$V_{OFF}$	20	60	100	V	
	Continuous load current (ACpeak/DC)	$I_{O\text{ Main}}$	200	800	550	mA	
		$I_{O\text{ Sub}}$		400			
	ON current reduction rate	$\Delta I_{O\text{ Main}/^\circ\text{C}}$	-2	-8	-5.5	$\text{mA}/^\circ\text{C}$	$T_a \geq 25^\circ\text{C}$
		$\Delta I_{O\text{ Sub}/^\circ\text{C}}$		-4			
Pulse ON current	$I_{OP}$	600	2400	1650	mA	$t=100\text{ ms}, \text{Duty}=1/10$	
Junction temperature	$T_j$	125			$^\circ\text{C}$		
Dielectric strength between I/O *	$V_{I-O}$	500			$V_{rms}$	AC for 1 min	
Ambient operating temperature	$T_a$	-40 to 110			$^\circ\text{C}$	With no icing or condensation	
Ambient storage temperature	$T_{stg}$	-40 to 125			$^\circ\text{C}$		
Soldering temperature	-	260			$^\circ\text{C}$	10 s	

Note: The product structure is sensitive to static electricity. When handling it, be sure to take measures against static electricity for the workbench, workers, soldering iron, and soldered mounted devices.

\* The dielectric strength between the input and output was checked by applying voltage between all pins as a group on the input (LED) side and all pins as a group on the output side (MOSFET).

## Electrical Characteristics (Ta=25°C)

Item	Symbol	G3VM-21MT	G3VM-61MT	G3VM-101MT	Unit	Measurement conditions
Input	LED forward voltage for main control	V <sub>F Main</sub>	2.2		V	I <sub>F Main</sub> =10 mA
		Minimum	2.54	2.42		
		Maximum	2.8			
	LED forward voltage for sub control	V <sub>F Sub</sub>	1.1		V	I <sub>F Sub</sub> =10 mA
		Minimum	1.27	1.21		
		Maximum	1.4			
	Capacitance between main control terminals	C <sub>T Main</sub>	15		pF	V=0, f=1 MHz
Capacitance between sub control terminals	C <sub>T Sub</sub>	30				
Trigger LED forward current	I <sub>FT Main/Sub</sub>	3		mA	I <sub>O</sub> =100 mA	
Release LED forward current	I <sub>FC Main/Sub</sub>	0.1				I <sub>OFF</sub> =10 uA
Output	Maximum resistance with output ON	R <sub>ON Main</sub>	8		Ω	I <sub>F Main</sub> =5 mA, t<1 s I <sub>O Main</sub> =Continuous load current rated value
		Typical	12	0.8		
	Current leakage when the main line is open and sub line is close *1	I <sub>LEAK</sub>	1		pA	G3VM-21MT: V <sub>DD</sub> =20 V G3VM-61MT: V <sub>DD</sub> =50 V G3VM-101MT: V <sub>DD</sub> =80 V *1
	Capacitance between terminals	C <sub>OFF</sub>	0.6		pF	V=0, f=1 MHz
Maximum		1	38	23		
Capacitance between I/O terminals	C <sub>I-O</sub>	1				
Insulation resistance between I/O terminals	R <sub>I-O</sub>	Minimum		1000	MΩ	V <sub>I-O</sub> =500 VDC, RoH ≤ 60%
		Typical		10 <sup>8</sup>		
Main line Turn-ON time	t <sub>ON Main</sub>	Typical		-	ms	G3VM-21MT: V <sub>DD</sub> =10V, G3VM-61MT/101MT: V <sub>DD</sub> =20V, I <sub>F Main</sub> =5 mA, R <sub>L</sub> =200 Ω *2
		Maximum		0.3		
Main line Turn-OFF time	t <sub>OFF Main</sub>	Typical		-	ms	G3VM-21MT: V <sub>DD</sub> =10V, G3VM-61MT/101MT: V <sub>DD</sub> =20V, I <sub>F Main</sub> =5 mA, I <sub>F Sub</sub> =5 mA, R <sub>L</sub> =200 Ω *3
		Maximum		0.3		
Sub line Turn-ON time	t <sub>ON Sub</sub>	Typical		-	ms	G3VM-21MT: V <sub>DD</sub> =10V, G3VM-61MT/101MT: V <sub>DD</sub> =20V, I <sub>F Main</sub> =5 mA, I <sub>F Sub</sub> =5 mA, R <sub>L</sub> =200 Ω *3
		Maximum		0.3		
Sub line Turn-OFF time	t <sub>OFF Sub</sub>	Typical		-	ms	G3VM-21MT: V <sub>DD</sub> =10V, G3VM-61MT/101MT: V <sub>DD</sub> =20V, I <sub>F Main</sub> =5 mA, I <sub>F Sub</sub> =5 mA, R <sub>L</sub> =200 Ω *3
		Maximum		0.3		

\*1. I<sub>LEAK</sub> measurement condition

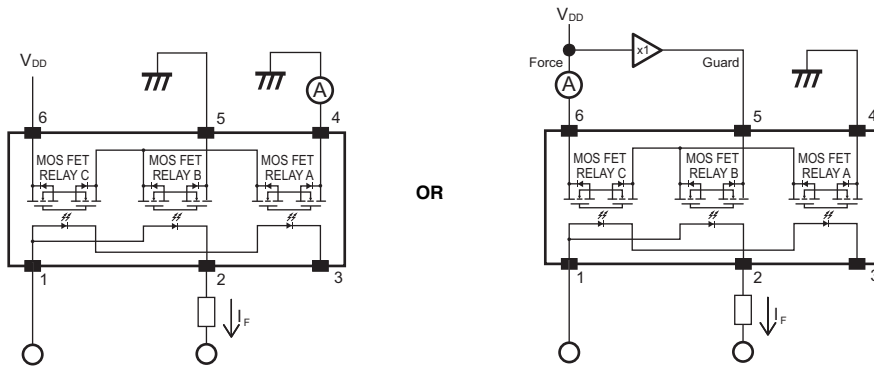

\*2. Turn-ON and Turn-OFF Times (Main line)

\*3. Turn-ON and Turn-OFF Times (Sub line)

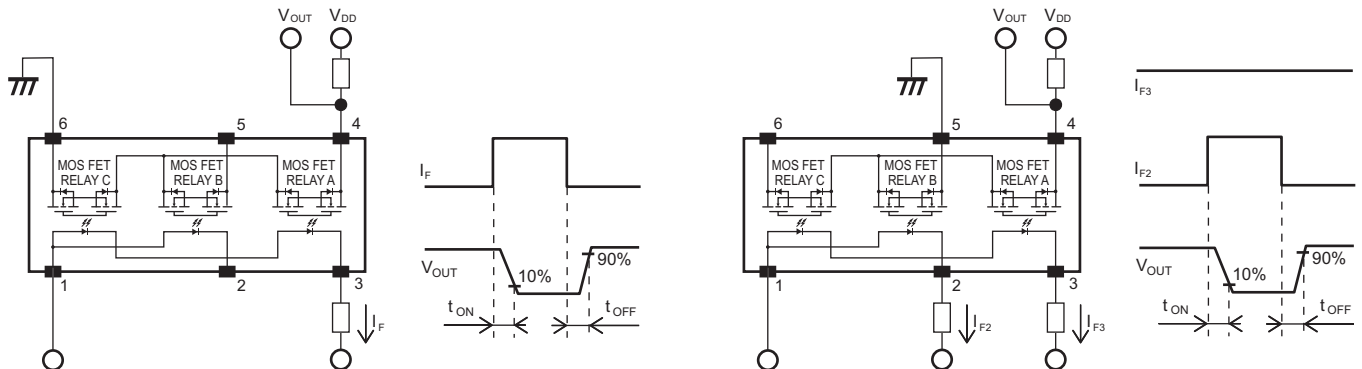

Module G3VM-□MT

## Recommended Operating Conditions

For usage with high reliability, Recommended Operation Conditions are measures that take into account the derating of Absolute Maximum Ratings and Electrical Characteristics.

Each item on this list is an independent condition, so it is not simultaneously satisfying conditions.

Item	Symbol		G3VM-21MT	G3VM-61MT	G3VM-101MT	Unit
Load voltage (AC peak/DC)	$V_{DD}$	Maximum	16	48	80	V
		Minimum		5		
Operating LED forward current	$I_F$	Typical		7.5		mA
		Maximum		20		
		Minimum				
Continuous load current (AC peak/DC)	$I_{O\ Main}$	Maximum	200	800	550	
	$I_{O\ Sub}$	Maximum		400		
Ambient operating temperature	$T_a$	Minimum		-20		°C
		Maximum		85		

## Engineering Data

### LED forward current vs. Ambient temperature

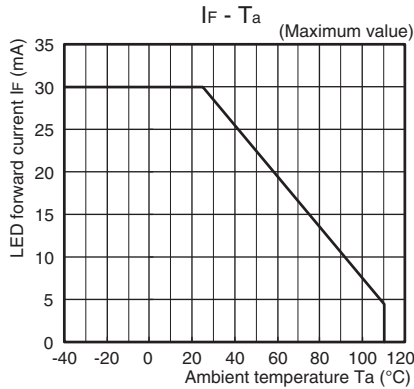

### Continuous load current vs. Ambient temperature

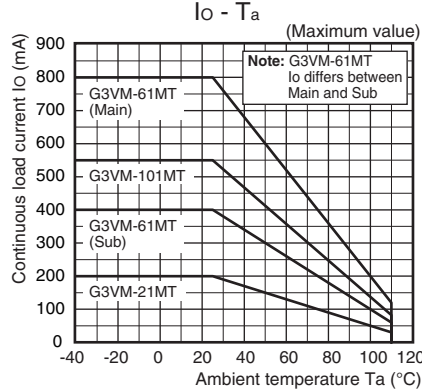

### LED forward current vs. LED forward voltage

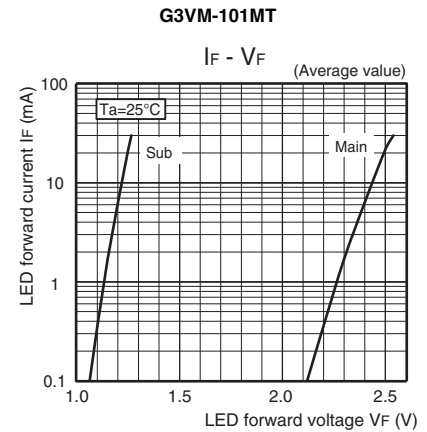
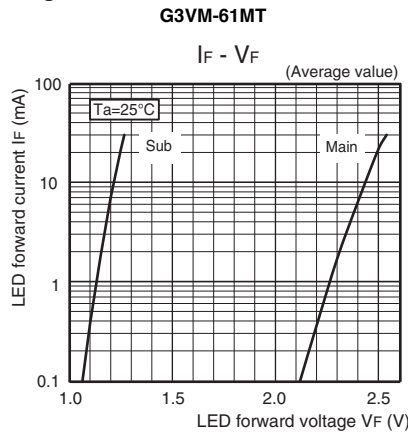
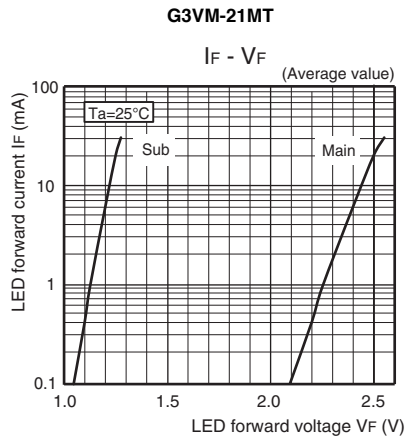

### Continuous load current vs. On-state voltage

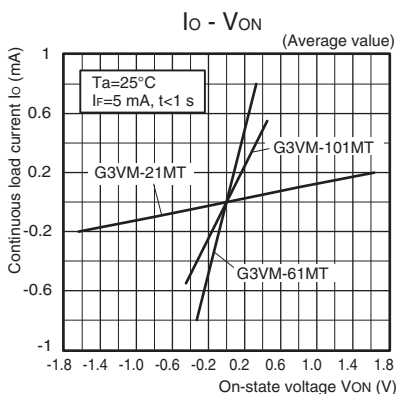

### On-state resistance vs. Ambient temperature

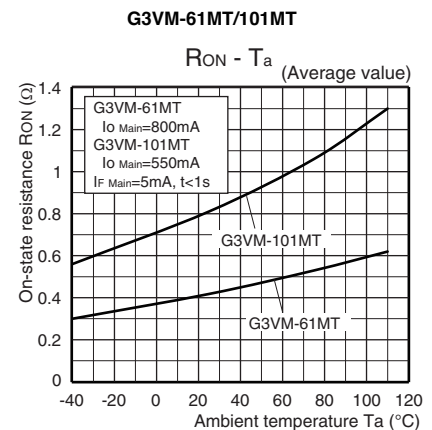
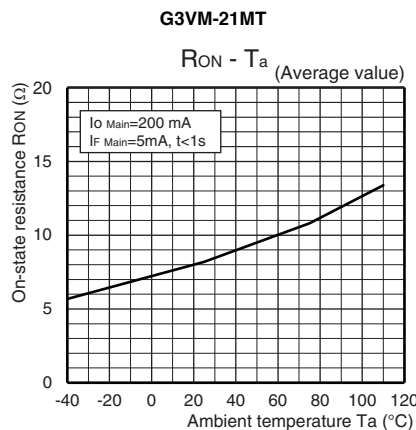

### ● Trigger LED forward current vs. Ambient temperature

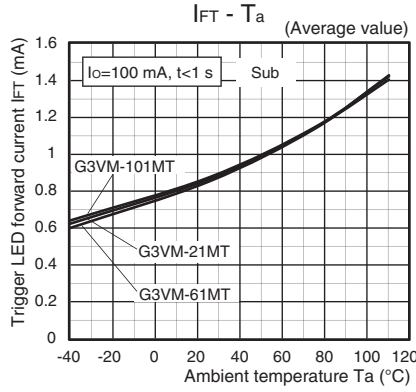
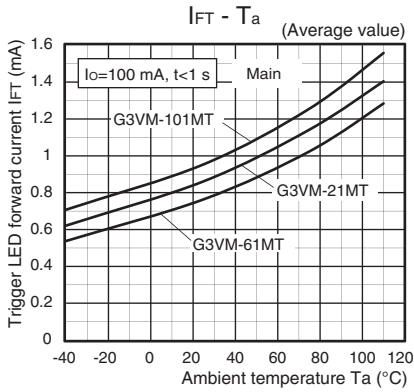

### ● Turn ON, Turn OFF time vs. LED forward current

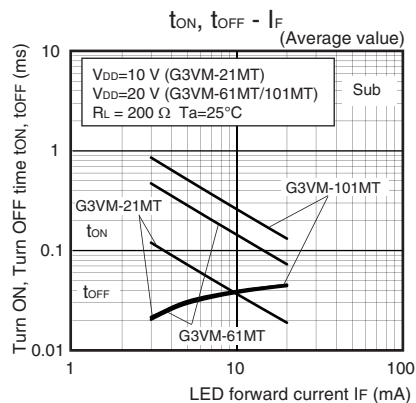
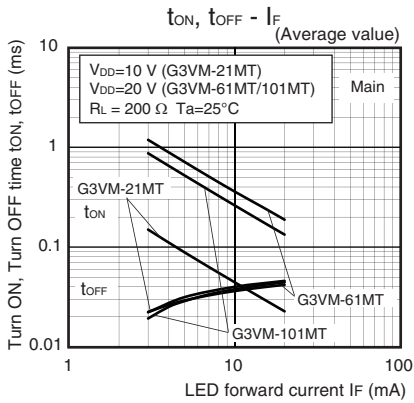

### ● Current leakage vs. Load voltage

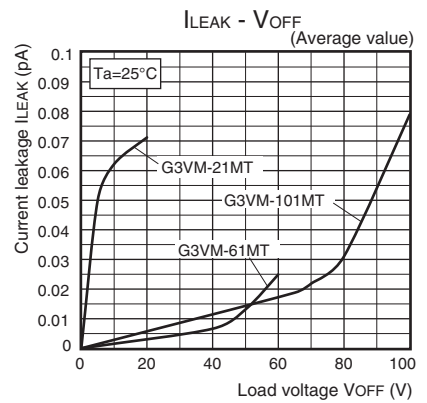

### ● Turn ON, Turn OFF time vs. Ambient temperature

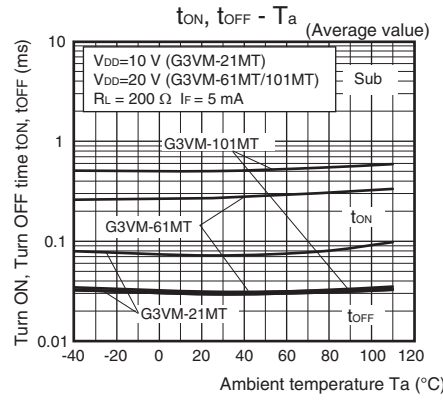
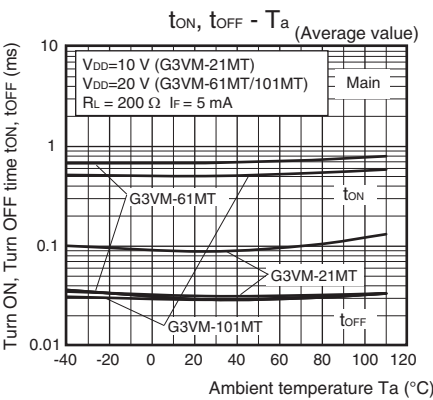

### ● Current leakage vs. Ambient temperature

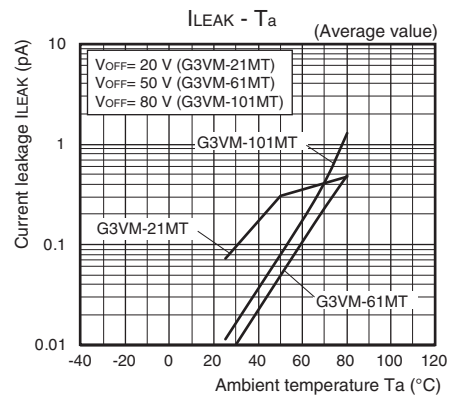

### ● Output terminal capacitance vs. Load voltage

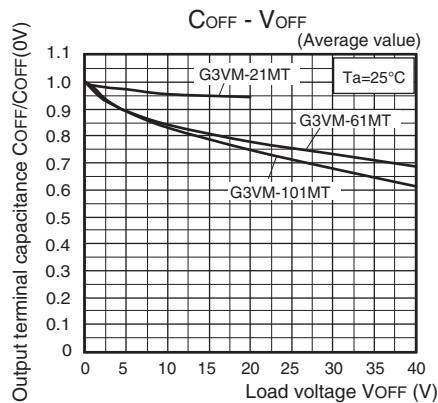

### ● High-frequency Characteristics (Isolation) \*1, \*2

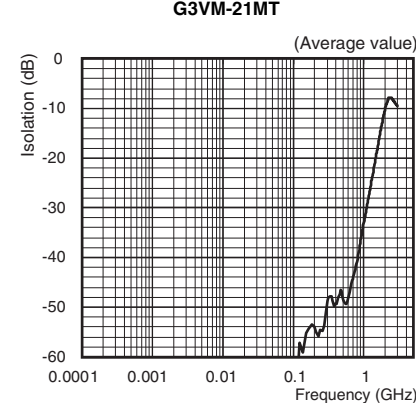

### ● High-frequency Characteristics (Insertion Loss) \*1, \*2

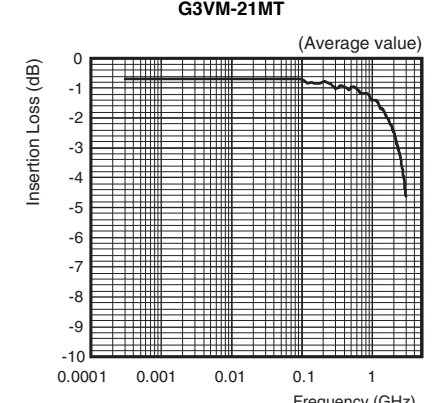

\*1. Ambient temperature condition: 25°C

\*2. The high-frequency characteristics depend on the mounting board. Be sure to check operation in actual equipment before use.

## ■Connection Example 1

### ●Device Functional Modes \*

Circuit	Control	MOS FET RELAY A, C (Main line)	MOS FET RELAY B (Sub line)
ON	H	ON	OFF
OFF	L	OFF	ON
-	X	OFF	OFF

\* H: Optional setting, L: 0 V, X: don't care

### ●Timing Diagram

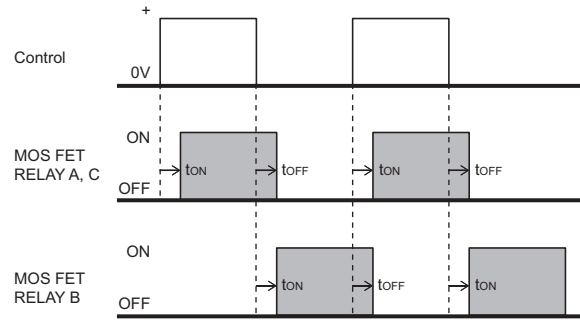

\* Both MOS FET relay A, C and MOS FET relay B may be ON at the same time. This products is recommended to use with dry switching (No Load & No Source when switching) to prevent short circuiting.

### ●Measurement Circuit

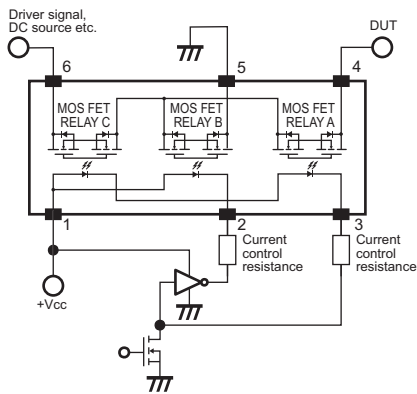

Note: Above image are pin numbers 1-6.

## ■Connection Example 2

### ●Device Functional Modes \*

If Main	If Sub	MOS FET RELAY A, C (Main line)	MOS FET RELAY B (Sub line)
H	L	ON	OFF
L	H	OFF	ON
L	L	OFF	OFF

### ●Timing Diagram

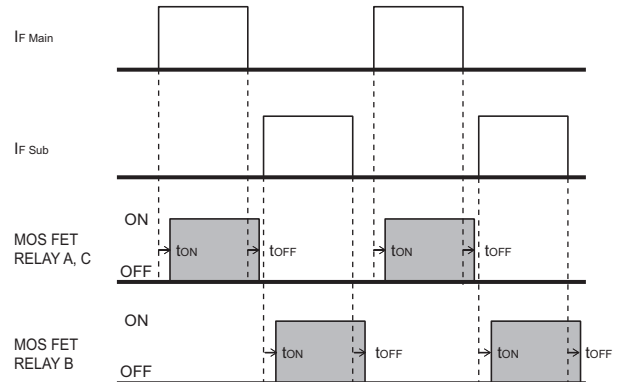

\* Both MOS FET relay A, C and MOS FET relay B may be ON at the same time. For that reason, even if pins 4, 5 and 6 are all connected, please design the circuit so that equipment damage does not occur.

### ●Measurement Circuit

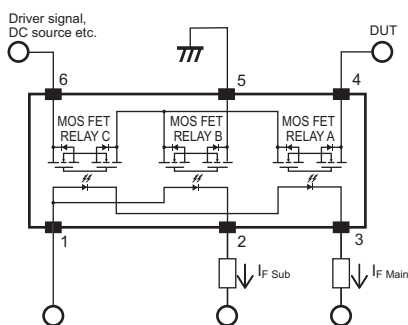

OR

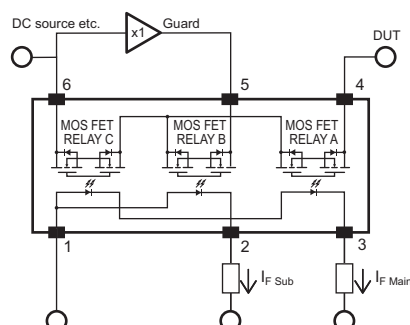

## ■Appearance / Terminal Arrangement / Internal Connections

### ●Appearance

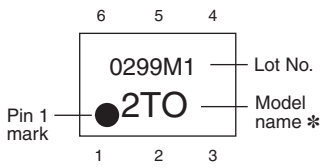

\* Actual model name marking for each model

Model	Marking
G3VM-21MT	2TO
G3VM-61MT	6TO
G3VM-101MT	ATO

**Note 1.** The actual product is marked differently from the image shown here.

**Note 2.** "G3VM" does not appear in the model number on the relay.

### ●Terminal Arrangement/Internal Connections (Top view)

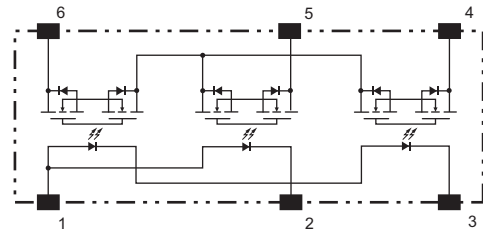

## ■Dimensions

**CAD Data**

Please visit our website, which is noted on the last page.

(Unit: mm)

### Surface-Mounting Terminals

Weight: 0.11 g

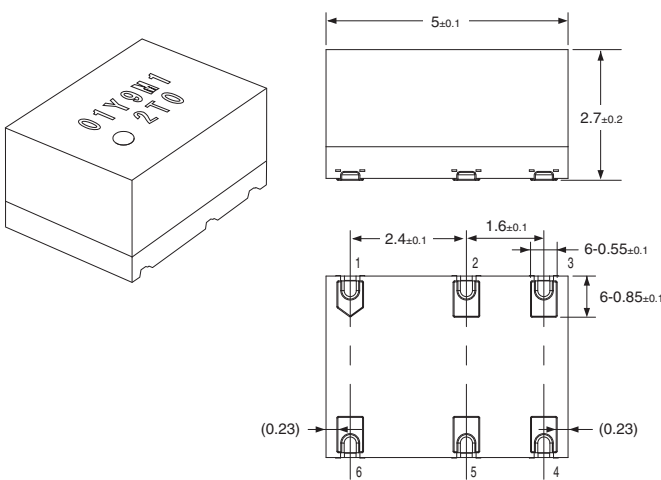

### Actual Mounting Pad Dimensions

(Recommended Value, Top view)

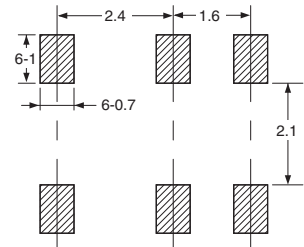

Unless otherwise specified, the dimensional tolerance is  $\pm 0.1$  mm.

**CAD Data**

**Note:** The actual product is marked differently from the image shown here.





## ●Protection from Surge Voltage on the Input Pins

- If any reversed surge voltage is imposed on the input pins, insert a diode in parallel with the input pins as shown in the following circuit diagram and do not impose a reversed voltage of 3 V or higher.

### Surge Voltage Protection Circuit Example

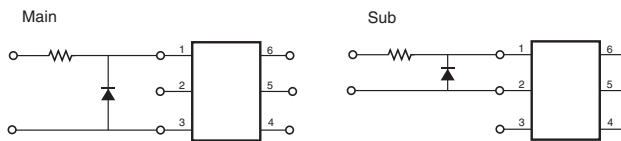

## ●Protection from Spike Voltage on the Output Pins

- If there is an inductive load or other condition that will cause overvoltage that exceeds the absolute maximum rating between the output pins, connect a protective circuit to limit the overvoltage.

### Spike Voltage Protection Circuit Example

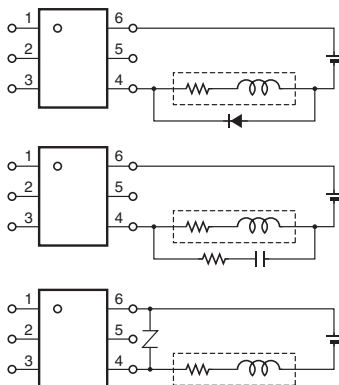

## ●Load Connection

- Do not short-circuit the input and output pins while the product is operating or it may malfunction.
- Do not connect the input and output in reverse.
- Do not construct a circuit so that overcurrent and burning occur if the 4, 5 and 6 pins are short-circuited.

## ●Transportation

- When transportation and installing the product, do not drop the product or subject it to abnormal vibration or shock. It may cause deterioration of product characteristics, malfunction or failure.
- Avoid transportation in the following conditions as it may cause failure or deterioration of characteristics.
  - Circumstance subject to water or oil.
  - Circumstance subject to high temperature or high humidity.
  - Circumstance where the temperature changes radically and condensation occurs.
  - State the product is not packed.

## ●Cleaning Flux from the Products

- Clean flux from the product so that there will be no residue of reactive ions, such as sodium or chlorine.
 

Some organic solvents will react with water to produce hydrogen chloride or other corrosive gases, which may cause deterioration of the products.
- When washing off the flux with water, make sure that there will be no residue of reactive ions, particularly sodium or chlorine.

- During water washing, do not scrub the marks on the surface of the product with a brush or your hand while there is cleaning liquid on the product. The marks may come off.
- Clean the flux from the products with the chemical action of the solvent for submersed cleaning, shower cleaning, or steam cleaning. To minimize the effect on the products, do not place the product in the solvent or steam for more than 1 minute at a temperature of 50°C.
- If you use ultrasonic cleaning, keep the time short. If the cleaning time is too long, the sealing characteristics of the molded resin and frame materials may deteriorate. The recommended basic conditions are given below.
 

Recommended Conditions for Ultrasonic Cleaning:  
 Frequency: 27 to 29 kHz  
 Ultrasonic wave output: 300 W max. (0.25 W/cm<sup>2</sup> max.)  
 Cleaning time: 30 s max.

Also, suspend the products in the cleaning solution so that the product and PCB do not come into direct contact with the ultrasonic transducer.
- Dry thoroughly after washing so that there is no residue of washing liquid.

## ●Solder Mounting

Perform solder mounting under the following recommended conditions to prevent the temperature of the MOS FET Relays from rising.

### (Lead-free solder) SnAgCu recommended profile

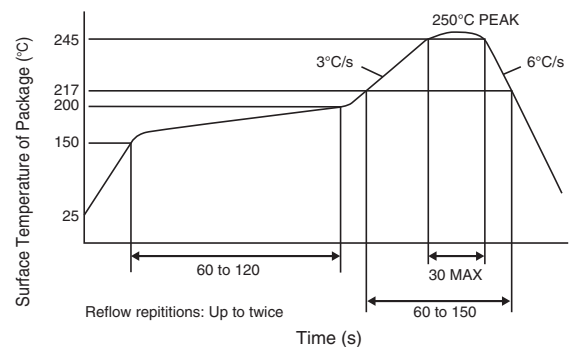

**Note 1.** We recommend that you verify the suitability of solder mounting under actual conditions.

**Note 2.** When product is ordered with (TR01), tape package product is delivered in moisture-proof packaging. If ordered without (TR01), tape-cut product is delivered in non moisture-proof packaging. Mount a tape cut product by manual soldering. Tape cut products absorb moisture because a non moisture-proof package is used. Risk of package cracking or other damage due to thermal stress if reflow soldering is performed.

### Manual Soldering (Once Only)

Perform manual soldering at 260°C for 10 s or less.

## ●Storage Conditions

- Store the products where they will not be subjected to water leaks or direct sunlight.
- When transporting or storing the product, observe all precautions on the packaging boxes.
- Keep the storage location at normal temperature, normal humidity, and normal pressure. Guidelines for the temperature and humidity are 5 to 35°C and a relative humidity of 45% to 75%.
- Do not store the product in locations that are subject to corrosive gases, such as hydrogen sulfide gas, or to salt spray, and do not store them where there is visually apparent dust, iron powder or dirt.



- (5) Store the product in a location that has a relatively stable temperature. Radical changes in temperature during storage will cause condensation, which may oxidize or corrode the leads and interfere with solder wetting.
- (6) If you remove products from the packages and then store them again, use storage containers that have measures to prevent static electricity.
- (7) Do not under any circumstances apply any force to the products that would deform or alter them in any way.
- (8) This product is warranted for one year from the date of purchase or the date of delivery to the specified location. If the products are stored for more than about one year under normal conditions, we recommend that you confirm solderability before you use the products.

### ●Usage Conditions

#### <Mounting>

Do not install the product with oil or metal powder.

This may cause insulation deterioration.

#### <Temperature>

The electrical characteristics of the products are limited by the application temperature.

If you use them at temperatures outside of the operating temperature range, the electrical characteristics of the products will not be achieved and the products may deteriorate. For that reason, you must determine the temperature characteristics in advance and apply derating\* to the design of the application. (\*Derating reduces stress.) Consider derating in the operating temperature conditions and apply the recommended operating temperature as a guideline.

#### <Humidity>

To ensure long-term reliability, consider derating the operating humidity conditions and operate within the following humidity range.

When operating in a high-humidity environment, moisture intrusion may cause deterioration or failure of the internal semiconductor elements. Also, in systems with high signal source impedance, leakage current between the board and product reeds can cause a malfunction.

When operating in a low-humidity environment, suppress the generation of static electricity as much as possible and take appropriate measures to prevent static electricity buildup around the product.

Static electricity discharge may damage the semiconductors inside the element and prevent normal operation.

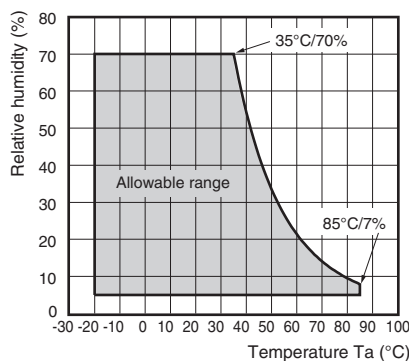

**Note:** No icing or condensation within the operating temperature range.

#### <Replace>

- Be sure to turn off the power when replacing parts. There is a risk of electric shock.

#### <Disposal>

- This product uses compound semiconductors containing GaAs (gallium arsenide). Do not destroy, cut, crush or chemically decompose the product as the powder and vapor generated are harmful to the human body.

### ●Considerations when handling Products

#### <Moisture proof package, MSL5>

Surface mount products may have a crack when thermal stress is applied during surface mount assembly after they absorb atmospheric moisture. Therefore, please observe the following precautions.

- (1) This moisture proof bag may be stored unopened within 12 months at the following conditions.  
Temperature: 5°C to 30°C  
Humidity: 90% (Max.)
- (2) After opening the moisture proof bag, the devices should be assembled within 48 hours in an environment of 5°C to 30°C / 60%RH or below.
- (3) If upon opening, the moisture indicator card shows humidity 30% or above (Color of indication changes to pink) or the expiration date has passed, the devices should be baked in taping with reel. After baking, use the baked devices within 48 hours, but perform baking only once.  
Baking conditions: 120±5°C. For 72 hours.  
Expiration date: 12 months from sealing date, which is imprinted on the label affixed.
- (4) Repeated baking can cause the peeling strength of the taping to change, then leads to trouble in mounting. Furthermore, prevent the devices from being destructed against static electricity for baking of it.
- (5) If the packing material of laminate would be broken the hermeticity would deteriorate.  
Therefore, do not throw or drop the packed devices.
- (6) Tape-cut products are packaged without humidity resistance. Use manual soldering to mount them. (MSL not supported)

Please check each region's Terms & Conditions by region website.

## OMRON Corporation

Device & Module Solutions Company

### Regional Contact

#### Americas

<https://components.omron.com/us>

#### Asia-Pacific

<https://components.omron.com/ap>

#### Korea

<https://components.omron.com/kr>

#### Europe

<https://components.omron.com/eu>

#### China

<https://components.omron.com.cn>

#### Japan

<https://components.omron.com/jp>