

# Safety Precautions for All Automotive Relays

---

## Precautions for Safe Use

### ● Notice to ensure safety

- This relay is intended for automotive use only. Do not subject it to any other use. Refer to the specification and confirm that the relay meets the application before using any relay from this catalog.
- Confirm acceptability for safety critical applications by appropriate testing or contact Omron.
- Do not use the relay for loads which exceed the rated values given in the data sheet. Failure to do so may result in unforeseen consequences such as insulation failure, smoking, breakdown of operation, etc.
- Do not apply over-voltage to the relay coil. Do not apply AC power to a DC relay coil. Be careful not to exceed the temperature ratings of the relay.
- Do not make incorrect connections to the relay terminals.
- Endurance (Lifetime) is significantly affected by changes to the load and switching condition. When using the relay, check the relay behavior with an actual product under actual conditions. Use the relay within timing characteristics it can meet according to the data sheet.
- Carry out the proper number of confirmation tests with an actual product for each application or contact Omron.
- A relay is a precision part. Do not apply vibration and shock beyond the specified value. Do not drop the relay. Do not use a relay that has been dropped.
- Do not remove the case of a relay or modify the terminals in any way.
- Do not touch the relay terminal or opposing mating terminal while applying current. Electric shock may occur.
- Do not use a relay under any environment that contains flammable or explosive gas. Fire or an explosion may result.

### ● When using a relay

- As with all technologies, relays may not always behave as expected. Therefore, evaluation under actual application conditions is always best.
- Each performance rating in this catalog is based on the value under controlled conditions (i.e. temperature, humidity, etc 86 to 106kPa) unless otherwise specified. Confirm not only load condition but also actual environmental conditions for actual use.
- Reference data in the catalog is based on measurement values from sampling of production. The values are as accurate as possible and believed to be correct at the time of publication. Due to production necessity or other reasons, specifications may change without notice.
- When a relay is used outside the recommended conditions, there is no way for Omron to predict the failure mode or results of the failure. Omron will remain blameless for the results of applying relays outside of the recommended parameters described in this catalog.

# Safety Precautions for All Automotive Relays

## Precautions for Correct Use

### Table of contents

No.	Classification	No.	Item	Page
①	Coil Input	(1)	Maximum Applicable Voltage	21
		(2)	Applied Voltage to the Coil	
		(3)	Ripple Ratio of Coil Current	
		(4)	Waveform of Applied Voltage to the Coil	
		(5)	Lack of Applied Voltage	
		(6)	Coil Polarity	
		(7)	Changes in Operating Voltage due to Coil Temperature Rise	
		(8)	Load Switching Frequency	
		(9)	Infrequent Switching and Dry Switching	22
		(10)	Continuous Energization for Extended Periods	
		(11)	Surge Protection	
		(12)	Leakage Current to the Coil	
②	Contact Output (Load Circuit)	(1)	Maximum Switching Power	22
		(2)	Switching Current	
		(3)	Switching Endurance	
		(4)	Resistive Loads and Inductive Loads	
		(5)	Contact Switching Phenomenon	
		(6)	Contact Protection Circuit (Arc Reduction)	
		(7)	Surge Protection from the External Circuit	23
		(8)	Motor Switching for Forward and Reverse Operation	
		(9)	Different Capacity Load Connection	
		(10)	Power Supply Switching	
		(11)	Circuits in which Contact a Contact Short Occurs	
③	Mounting Design	(1)	Lead Wire Diameter for Wiring	24
		(2)	Socket Mounting	
		(3)	Installation Direction	
		(4)	Relays mounted close to a CPU	
④	Storage and Usage Environment	(1)	Using, Transporting and Storing the Relay	25
		(2)	Ambient Environment	
		(3)	Gases (Silicone gas, sulfuric gas, organic gas)	
		(4)	Dust	
		(5)	Exportation to a Tropical Region	
		(6)	Invasion of Water, Chemicals, Solvents, & Oil	
		(7)	Vibration and Shock	
		(8)	External Magnetic Field	
		(9)	External Physical Loads	
		(10)	Adhesion of Magnetic Particles	

No.	Classification	No.	Type/Item	No.	Item	Page
⑤	Relay Mounting	(1)	Common Subdivision	①	Do not solder a tab terminal.	26
				②	Do not cut a terminal	
				③	Terminal deformation	
				④	Relay replacement and wiring	
				⑤	Coating and packing	
		(2)	PCB Relay	①	Ultrasonic cleaning	
		(3)	Plug-in Relay	①	Front connection socket	
				②	Relay insertion/removal direction	
⑥	Relay for Automobile PCB	(1)	PCB Selection	①	PCB Materials	26
				②	PCB Thickness	
		(2)	Mounting Interval	①	Ambient Temperature	
				②	Mutual Magnetic Interference	
		(3)	Pattern Layout to Protect from Noise (EMI)	①	Noise from the Coil	
				②	Noise from the Contact	
		(4)	Shape & Position of Solder Pads			
		(5)	Stabilization Method for PCB			
(6)	Automatic Mounting of Relays on PCBs			28		
(7)	Terminal Shape			31		
(8)	Protection Construction					

## ① Coil Input

### (1) Maximum Applicable Voltage

The maximum voltage applicable to a relay is determined in accordance with the coil temperature rise and the coil insulation material's thermal stability. If the thermal limit of the wire insulation is exceeded, the coil may become damaged by burning or a coil layer short may occur. Do not exceed the values given in the catalog; failure to do so may cause unfavorable results.

### (2) Applied Voltage to the Coil

The voltage applied to the coil should not exceed the rated voltage. Applying a voltage that exceeds the rating decreases the switching time, but can also contribute to a deterioration in durability performance due to an increased incidence of contact bounce, and a shorter relay life due to an increased operating temperature.

### (3) Ripple Ratio of Coil Current

The power source for DC-operated relays is in principle, a power source with a maximum ripple of 5%. If the ripple of the voltage applied to the coil is too great, undesirable performance characteristics may emerge. For instance, in a half-wave rectifier circuit with a smoothing capacitor, the ripple increases as the value of the smoothing capacitor decreases.

### (4) Waveform of Applied Voltage to the Coil

A coil voltage signal that gradually increases or decreases is not desired. A rectangular (square) waveform is preferred. It cannot be assumed that the relay will operate or release at the moment the coil voltage reaches the limits shown on the specification sheet. Voltage applied to the coil should increase or decrease sharply. Otherwise contact operation time may be prolonged or other malfunction may occur. With longer operating and release times, contact endurance may decrease. Also, contact welding may occur.

### (5) Lack of Applied Voltage

When the applied voltage to the coil is low, the relay may not operate or its behavior may become unstable. Contact endurance may decrease, or contact welding may occur (among other possible drawbacks.) Also, relay malfunction can occur below the specified vibration and shock values. Hence, the rated coil voltage should be applied to the relay coil.

### (6) Coil Polarity

It is necessary to apply the correct polarity to the coil in instances where the coil has a diode or other polarity sensitive device employed as a surge suppressor. Applying reverse polarity will damage the suppression device and possibly cause damage to the circuit in which the relay is installed.

When using a polarized (latching or moving loop) relay, a permanent magnet is employed. In such instances, the relay will not operate if the coil voltage or pulse is applied in the opposite polarity.

### (7) Changes in Operating Voltage due to Coil

#### Temperature Rise

The specified operating voltage value in the catalog may not be satisfied under hot start conditions and/or an ambient temperature greater than 20°C. It is necessary to confirm operation under the actual conditions in which the relay will be used. Coil resistance and operating voltage will increase linearly as the coil temperature rises. The temperature coefficient of resistance for copper wire is about 0.4% per 1°C, and the coil resistance increases at the same ratio. Values for operating and release voltage in the catalog are given at 20°C.

# Safety Precautions for All Automotive Relays

## (8) Load Switching Frequency

The acceptable maximum switching frequency will vary with the type of load, voltage, current, etc. The user must confirm operation under actual application conditions. When the switching frequency is beyond the relay's capabilities, it may be impossible for the relay to interrupt the circuit properly.

## (9) Infrequent Switching and Dry Switching

If a relay is used under a condition where it is subjected to very infrequent switching, the contacts may naturally form non-conductive surface films. These films may produce an unstable or unreliable contact resistance. This condition is also observed when "dry" circuits are switched (meaning little or no contact current.) The development of these films is highly dependant on environment and load type. It is imperative that these conditions be considered and evaluated. Circuitry can be employed to lessen or eliminate the appearance of this phenomenon.

## (10) Continuous Energization for Extended Periods

It is not recommended to use a relay in a circuit where the coil is energized for long periods (such as months or years.) These conditions are severe on the coil and contacts.

## (11) Surge Protection

The reverse voltage that is generated by the coil when it is switched off can cause damage to a semiconductor used to drive the coil and may result in circuit malfunction. Some countermeasures are to attach a surge suppressor to both ends of the coil or to select a model with a built-in surge suppressor. As surge suppression will cause the release time to increase, operation in the actual circuit should be confirmed.

When using a diode for surge suppression, it is good to use a device that has tolerance for external surges. Repeated peak inverse voltage rating and forward bias current rating should be considered.

Surge voltages shall not be applied to the relay coil. An instance where this may occur would be one in which an inductor is in parallel with the relay's coil. The surge generated by the inductor may damage the relay coil's surge protection device (resistor or diode) if so equipped.

## (12) Leakage Current to the Coil

Leakage current should not be allowed to pass through the relay's coil. See Improvement example 1 and 2.

Example of a circuit in which leakage current occurs:

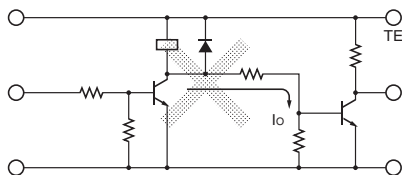

Improvement example 1:

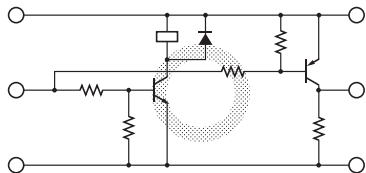

Improvement example 2: The case output value, which is the same phase as input, is necessary.

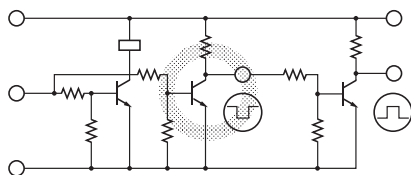

## ② Contact Output (Load Circuit)

### (1) Maximum Switching Current

The maximum switching current is the maximum current that the contacts can switch. The inrush current and cutoff current must also not exceed the maximum switching current. Repeated switching at the maximum switching current is not possible. Confirm durability (life) under the actual load.

### (2) Switching Current

The current applied to contacts during switching will have a significant effect on the contacts' performance. Motors and lamps produce large inrush currents. As inrush current increases, the amount of contact material consumption and transfer will increase. Deposits, pip and crater, or other conditions, lead to mechanical locking and other contact malfunctions. (See below for typical examples of the relationship between load and inrush current.) If a current greater than the rated current is applied from a DC source, it is possible to have a situation where the opening contacts can not extinguish the arc. A continuous uninterruptible arc may occur.

### DC Loads and Inrush Current

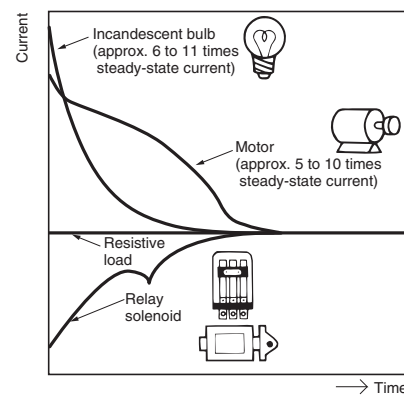

### (3) Switching Endurance

Switching endurance depends on many factors such as; the drive circuit for the coil, load type, switching frequency, switching phase, and ambient conditions. Evaluation under actual conditions is necessary. The switching endurance in the catalog is based on the following information.

<b>Coil drive circuit</b>	Rated voltage applied to the coil. (By increasing/decreasing voltage sharply.)
<b>Load type</b>	Rated load.
<b>Switching frequency</b>	By each rating.
<b>Ambient Conditions</b>	By standard test condition.

### (4) Resistive Loads and Inductive Loads

The maximum acceptable switching power for an inductive load is lower than that of a resistive load of equal current draw due to the influence of the electromagnetic energy stored in the inductive load.

### (5) Contact Switching Phenomenon

Contact switching occurs when switching a DC load when one contact melts or evaporates and transfers to another contact, and results in unevenness as the number of switching operations increase.

Eventually, this unevenness becomes locked and appears as if the contacts were welded.

This often occurs in circuits that generate sparks when the contacts are closed, i.e., when the current is large with DC inductive or a capacitive load or when the inrush current is large (e.g. several amps to tens of amps).

Contact protection circuits or contacts made of materials, which are resistant to transfer, can be used as countermeasures. If this type of load is to be used, it is absolutely necessary to perform tests to confirm operation using the actual equipment.

## (6) Contact Protection Circuit (Arc Reduction)

It is recommended to employ a contact protection circuit to increase the service life of the relay, to suppress noise, and to prevent the generation of carbide and nitric acid which otherwise will be generated at the contacts during switching. Examples of surge suppressors are shown in the table below.

1. The effect of the protection cannot be assumed due to variation in the load or relay characteristics. Verify proper operation under actual load.
2. When using a surge suppressor, the release time may be prolonged. Operation under actual load should be verified.

### Examples of surge suppressors

Item	Circuit example	Applicability	Features and remarks	Element selection
Type		DC		
CR type		OK	Load impedance must be much smaller than the CR impedance. Current flows to the inductive load though CR when the contact is open.	Optimum C and R values are: C: 0.5 to 1 μF for 1A switching current. R: 0.5 to 1 Ω for 1V switching voltage. These values do not always match with the optimum values due to the nature of the load and the dispersion in the relay characteristics.
		OK	Release time of the contacts will be delayed in case the load is inductive (relay, solenoid, etc.)	Confirm the optimum values through experiment. Capacitor C suppresses the discharge when the contacts are opened, while resistor R limits the current applied when the contacts are closed the next time. Generally, use C whose dielectric strength is 200 to 300 V. If the circuit is used with AC power source, use an AC capacitor (without polarity).
Diode type		OK	The energy stored in a coil (inductive load) is routed through the coil as current by the diode connected in parallel with the coil, and is dissipated as Joule heat by the resistance of the inductive load. This type of circuit delays the release time more than the CR type.	Use a diode having a reverse breakdown voltage of more than 10 times the circuit voltage, and a forward current rating greater than the load current. A diode having a reverse breakdown voltage two or three times that of the supply voltage can be used in an electronic circuit where the circuit voltage is not particularly high.
Diode + Zener diode type		OK	This circuit is effective in an application where the diode type protection circuit alone is not sufficient because the release time is delayed too much.	The breakdown voltage to the zener diode should be about the same as the supply voltage.
Varistor type		OK	This circuit prevents a high voltage from being applied across the contacts by using the constant-voltage characteristic of a varistor. This circuit also somewhat delays the release time. This circuit is effective if connected across the load when the supply voltage is 24 to 48 V. If the supply voltage is 100 to 200 V, connect the circuit across the contacts.	The cutoff voltage (Vc) must satisfy the following condition. For AC, it must be multiplied by the square root of 2. $V_c > (\text{Supply voltage} \times 1.5)$ However, cutoff will not work for a high voltage if Vc is set too high.

Avoid use of a surge suppressor in the instances shown below.

<p>This circuit arrangement is very effective for diminishing arcing at the contacts when breaking the circuit. However, since electrical energy is stored in C (capacitor) when the contacts are open, short-circuit current of C flows into the contacts when they are closed. Therefore, metal deposition is likely to occur between mating contacts.</p>	<p>This circuit arrangement is very useful for diminishing sparking (arcing) at the contacts when breaking the circuit. However, metal deposition is likely to occur between the mating contacts.</p>
--	---

Note: Although it is considered that switching a DC inductive load is more difficult than a resistive load, an appropriate contact protection circuit can come close to achieving parity of performance.

## (7) Surge Protection from the External Circuit

The protection circuit, such as a surge suppressor, should be attached in the area where the surge exceeds the withstand voltage value of the relay. Insulation breakdown and short circuit may occur between the coil and contact, where the voltage exceeding the maximum withstand voltage is applied, or between contacts of opposite polarity.

## (8) Motor Switching for Forward and Reverse Operation

In the case of switching a motor for forward and reverse operation, two relays or a dual relay should be used (See the figure below.) The lag-time (OFF time) in the operation sequence of the relays should be 100ms minimum.

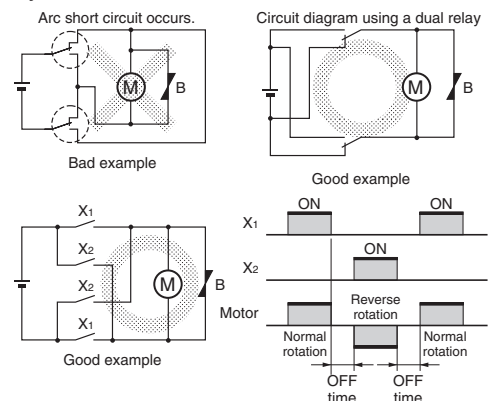

# Safety Precautions for All Automotive Relays

## (9) Different Capacity Load Connection

One relay should not be used to switch both a large and small load. Switching a large load can impair the cleaning performance of a contact when switching a small load and result in contact failure.

## (10) Short-circuiting Due to Arcing between NO and NC Contacts in SPDT Relays

With Relays that have NO and NC contacts, short-circuiting between contacts will result due to arcing if the space between the NO and NC contacts is too small or if a large current is switched.

Do not construct a circuit in such a way that overcurrent and burning occur if the NO, NC, and SPDT contacts are short-circuited.

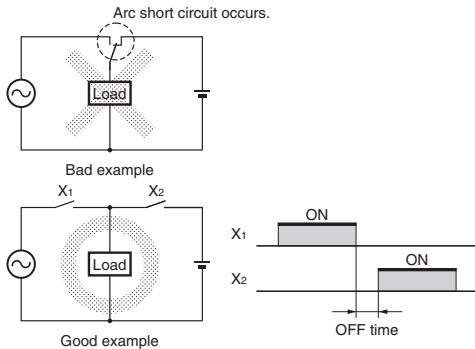

## (11) Using SPST-NO/SPST-NC Contact Relays as an SPDT Relay

Do not construct a circuit so that overcurrent and burning occur if the NO, NC and SPDT contacts are short-circuited. Also, with SPST-NO/SPST-NC Relays, a short-circuit current may flow for forward/reverse motor operation.

Shorts can be caused by non-synchronous operation of the A and B contacts. Contact shorts can also occur due to arcing if large currents are cut off when the A-contact and A-contact gaps are too small. (The contact signals that are used in the datasheets are used here.)

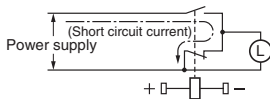

## ③ Mounting Design

### (1) Lead Wire Diameter for Wiring

The lead wire diameter is decided depending on the value of the load current. The chosen lead wire shall be at least the cross-sectional area shown in the following table. If the lead wire is thinner than required, burnout will occur due to abnormal heating of the wire.

Allowable current	Cross-sectional area (mm <sup>2</sup> )
6	0.75
10	1.25
15	2
20	3.5

### (2) Socket Mounting

When using a socket mounted relay, the lower rating of the two should be used. If the higher rating is used, abnormal heating will lead to burnout at the connected point.

### (3) Installation Direction

Relays shall be mounted in the direction detailed in this catalog. Mounting direction may differ depending on relay type.

### (4) Relays mounted close to a CPU

When a relay is mounted near a noise-sensitive device such as a CPU, consideration of noise interaction must be taken during trace and circuit design. A relay switching large currents will create noise due to arcing, possibly leading to CPU malfunction.

## ④ Storage and Usage Environment

### (1) Using, Transporting and Storing the Relay

When using, storing and transporting relays, avoid direct sunlight and keep normal temperature, humidity and pressure.

- Oxides or sulfurized films may accumulate on the contact surface if the relay is exposed to high temperature and humidity for long periods of time. That could be a root cause of failure like contact defect.
- Condensation may occur inside the relay if the ambient temperature changes sharply from a high temperature and humidity to a lower temperature. Condensation should be avoided because it may cause insulation failure. Furthermore, bluish-green compounds may be generated inside of the relay due to relatively strong arc discharge associated with contact switching at high humidity. Best overall relay performance is attained at low humidity.
- When relays have been stored for a long period of time, it is possible for various oxides to form on the terminals and contacts. Therefore, if such a situation were to occur, it is necessary to evaluate the readiness of relays for use.

### (2) Ambient Environment

- Do not use the relay in any area containing flammable or explosive gas. Fire or explosion may occur due to arcing or heating that is generated when switching the relay.
- Non-sealed relays should not be used in an excessively dusty environment. Loose contact may occur if dust enters the relay. It is recommended to use simple plastic sealed relays or metal hermetically sealed relays when a dusty application environment is foreseen.
- If a relay is used below freezing, contact obstruction may occur due to an ice film that can form on the contact surfaces as a result of the relationship between the amount of saturated water vapor and changes in internal relay temperature. Check for icing in the system units.

### (3) Gases (Silicone gas, sulfuric gas, organic gas)

Relays should not be used or stored near silicone, sulfuric (SO<sub>2</sub>, H<sub>2</sub>S) or organic gases. Degradation of the contacts may occur or solderability of the terminals may be adversely affected.

Storage or use in an environment containing silicone gas may cause loose contacts to occur. The following table shows some countermeasures.

Item	Process
Outer casing, housing	Sealed construction by using packing, etc.
Relay	Use of simplified hermetically sealed type relay, simple plastic sealed type relay (except silicone atmosphere)
PWB, copper film	Coating
Connector	Gold-plating, rhodium-plating process

### (4) Dust

When an unsealed relay is used or stored in an excessively dusty environment, contamination may enter the relay and obstruct the contacts or other moving parts. The result may be failure to physically or electrically close the contacts. Loose contacts or short circuit may occur if conductive substances enter the relay. In those cases, a fully sealed relay is recommended.

### (5) Exportation to a Tropical Region

When a relay will be used or stored in a tropical region, the following types are recommended:

- A Relay that is designed and manufactured specifically for tropical conditions.
- A simple plastic sealed relay
- A Hermetically sealed relay

Failure to consider application in tropical regions may lead to unexpected corrosion of metal parts.

### (6) Invasion of Water, Chemicals, Solvents, & Oil

Do not use or store the relay a place where it may be exposed to water, chemicals, solvents or oil. Rust, corrosion, resin deterioration or other adverse conditions may occur. Also, with solvents such as thinner or gasoline, parts may deteriorate and markings may disappear. With exposure to oils, a clear (polycarbonate) case may become clouded or cracked.

### (7) Vibration and Shock

Relays are precision components. Do not subject relays to vibration or shock that exceeds the specifications either before or after mounting them. Check the relevant datasheet for the allowable vibration and shock values.

Initial performance may not be maintained if the relays are subjected to abnormal vibration and shock.

Even if the relays are packed in sticks, do not subject them to vibration or shock that exceeds the specifications.

### (8) External Magnetic Field

Malfunction may occur if using the relay in the presence of a strong magnetic field. Do not use the relay in any location where external magnetic field of 800A/m or more exists. Arc discharge generated between contacts during switching is distorted in the presence of a magnetic field. A short circuit or insulation failure may occur.

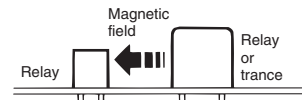

### (9) External Physical Loads

Do not use or store the relay in a state where a physical load or stress is applied to the relay from an external source. It could be a root cause that the relay causes malfunction or cannot keep the initial characteristics.

### (10) Adhesion of Magnetic Particles

Do not use the relay in the presence of magnetic particles. Performance of the relay may not be maintained if particles attach themselves to the case.

# Safety Precautions for All Automotive Relays

## ⑤ Relay Mounting

### (1) Common Subdivision

#### ① Do not solder a tab terminal

Do not solder a lead wire to a tab terminal. Contact failure can occur due to relay deformation and flux immersion.

#### ② Do not cut a terminal

Performance will be impaired.

#### ③ Terminal deformation

Deformed terminals should not be used, even after repair. Unacceptable force may be applied to the relay and initial performance may not be kept.

#### ④ Relay replacement and wiring

When replacing a relay or wiring, ensure safety by turning the power OFF at the coil and load before beginning work.

#### ⑤ Coating and packing

Flux, coating agent or packing resin shall not penetrate into a relay. Contact failure or operation defect can occur. When coating or packing, a simple plastic sealed relay shall be used. Coating agents and packing resin shall not contain silicone. When coating, relay operation in the actual unit shall be checked.

### Coating agent type

Item Type	Acceptable/Unacceptable to use on PCB	Characteristics
Epoxy	Acceptable	Insulation performance is good. Workability is sub-par.
Urethane	Acceptable	Insulation performance and workability are good. Many types of solvents are a thinner type which will not adhere to a relay.
Silicone	Unacceptable	Insulation performance and workability are good. Silicone gas will cause relay contact failure.

### (2) PCB Relay

#### ① Ultrasonic cleaning

Ultrasonic cleaning of relays shall not be performed. Contact sticking or coil disconnection may occur due to the resonance of internal components.

#### ② Mounting Relays on PCBs

Do not bend the terminal pins when you secure the Relays to the PCBs. Relay performance may be compromised.

### (3) Plug-in Relay

#### ① Front connection socket

##### • Screw to attach a socket

A front connection socket shall be attached firmly using screws after making attaching holes. If the socket is not securely fastened, a socket, lead wire, or relay may come off due to vibration or impact. A socket mounted to a 35mm DIN rail is also acceptable.

##### • Screwing a lead wire

A lead wire shall be tightened to the following torques.

① M3 screw socket: 0.78 to 1.18 N·m

② M3.5 screw socket: 0.78 to 1.18 N·m

③ M4 screw socket: 0.98 to 1.37 N·m

When using a front connection socket, a lead wire will come off and abnormal heating may occur if the screw is under-torqued. If the screw is over-torqued, the screw head may become stripped.

##### • A Holding clasp shall be used to maintain the reliable connection between the relay and a socket.

The relay may come off from a socket when abnormal vibration or impact is applied.

#### ② Relay insertion/removal direction

The insertion and removal of a relay shall be performed normal to the socket surface.



If the relay is inserted or removed at an angle, contact failure and relay terminal bending may occur.

## ⑥ Relay for Automotive PCB

### (1) PCB Selection

#### ① PCB Materials

Generally, the substrate of a PCB is made of glass epoxy, paper epoxy, or paper phenol. The table below shows various properties of typical types. PCB and relay selection should be made in light of the intended use. Of these, the glass-epoxy or paper-epoxy PCB is recommended for mounting relays.

Item	Epoxy-based		Phenol-based
	Glass epoxy (GE)	Paper epoxy (PE)	Paper phenol (PP)
Electrical characteristics	<ul style="list-style-type: none"> <li>High insulation resistance.</li> <li>Insulation resistance hardly affected by humidity.</li> </ul>	<ul style="list-style-type: none"> <li>Fair</li> </ul>	<ul style="list-style-type: none"> <li>Insulation resistance degraded by humidity.</li> </ul>
Mechanical characteristics	<ul style="list-style-type: none"> <li>Little expansions/shrinkage caused by change in temperature or humidity.</li> <li>Suitable for through-hole PCB and multi layer PCB.</li> </ul>	<ul style="list-style-type: none"> <li>Fair</li> </ul>	<ul style="list-style-type: none"> <li>Much expansions/shrinkage caused by change in temperature or humidity.</li> <li>Not suitable for through hole PWB and multi layer PWB.</li> </ul>
Cost effectiveness	<ul style="list-style-type: none"> <li>Expensive</li> </ul>	<ul style="list-style-type: none"> <li>Fair</li> </ul>	<ul style="list-style-type: none"> <li>Inexpensive</li> </ul>
Purpose	<ul style="list-style-type: none"> <li>High reliability and resistance to environmental effects.</li> </ul>	<ul style="list-style-type: none"> <li>Fair</li> </ul>	<ul style="list-style-type: none"> <li>Good for low density circuitry under moderate environmental conditions.</li> </ul>

#### ② PCB Thickness

PCBs having a thickness of 0.8, 1.2, 1.6 or 2.0mm are generally used. A PCB that is 1.6mm thick is best for mounting relays. This determination is based on relay weight and terminal length. If a PCB of insufficient thickness is used and displays warpage, relay performance may suffer. Care should be taken to consider board size, part weight, mounting methods and usage environment to avoid these complications.

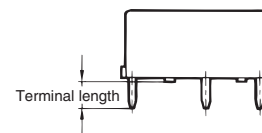

#### ③ Terminal Hole and Land Diameters

Refer to the following table to select the terminal hole and land diameters based on the Relay mounting dimensions. The land diameter may be smaller if the land is processed with through-hole plating.

Terminal hole diameter (mm)		Minimum land diameter (mm)
Normal value	Tolerance	
0.6	±0.1	1.5
0.8		1.8
1.0		2.0
1.2		2.5
1.3		2.5
1.5		3.0
1.6		3.0
2.0		3.0

## (2) Mounting Interval

### ① Ambient Temperature

For the mounting interval, follow the recommendations described in the catalog.

When many relays are mounted together, they may generate abnormally high heat due to the thermal interaction between the relays. Therefore, provide an adequate distance between the relays to dissipate the heat. When using a relay, be sure to check the minimum mounting interval.

Also, if multiple PCBs with relays are mounted within close proximity to each other, the temperature may rise. In this case, preventive measures must be taken so that the ambient temperature falls within the rated value.

### ② Mutual Magnetic Interference

Relay characteristics may change due to the magnetic field generated by other relays. If two or more relays will be mounted in close proximity to each other, use the relay only after checking for acceptable operation.

## (3) Pattern Layout to Protect from Noise (EMI)

### ① Noise from the Coil

When the relay coil is switched off, reverse electromotive force is generated by the collapsing of the coil's magnetic field. When this occurs EMI noise appears. A diode across the coil can help absorb the surge. The figure below is an example of a circuit used to reduce noise.

When laying out the PCB, make a separate trace for the coil power supply and employ a smoothing capacitor or other suppression device if needed in order to isolate the coil from the power line.

Make the PCB traces as short as possible to minimize the possibility that they may act as antennas for emission or acceptance of EMI.

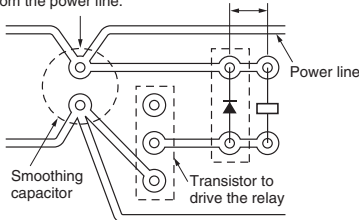

### ② Noise from the Contact

Noise may be introduced into the electronic circuit when switching loads that generate arcing on contact points. Examples would be any inductive load such as a motor, solenoid, or magnetic clutch. Consider the following points when determining the routing of conductors on the PCB:

1. Keep the current carrying path as far away from signal paths as possible.
2. Design the shortest possible current-carrying path.
3. Shield from the electronic circuit by employing a ground plane.

## (4) Shape & Position of Solder Pads

The solder pad should be on the center line of the copper-foil pattern, so that the soldered fillets become uniform.

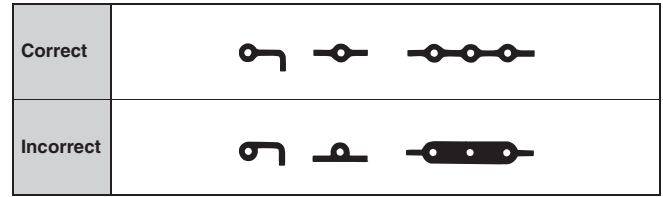

A break in the circular land area will prevent molten solder from filling holes reserved for components which must be soldered manually after the automatic soldering of the PCB is complete.



Determine the land dimensions taking into account the mounting accuracy of the moulder if a surface-mounted Relay is used.

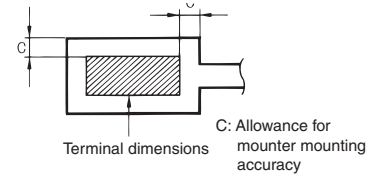

## (5) Stabilization Method for PCB

Although the PCB itself is not usually a source of vibration or shock, it may amplify or prolong the vibration by resonating with external vibrations or shocks. Securely fix the PCB, paying close attention to the following points.

Mounting method	Process
Rack mounting	No gap between rack's guide and PCB
Screw mounting	Securely tighten screws. Place heavy components such as relays on part of PCB near where screws are to be used. Attach rubber washers to screws when mounting components that are affected by shock. (such as audio devices.)

# Safety Precautions for All Automotive Relays

## (6) Automatic Mounting of Relays on PCBs

### ① Though-hole Mounting

The following tables list the processes required for mounting a relay onto a PCB along with recommendations at each point in the process:



Process 1
Placement

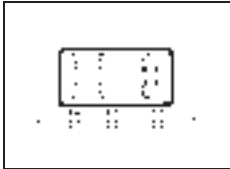

<p>① Do not bend any terminal of the relay for the purpose of holding it on a PCB. Doing so may cause the relay to malfunction.</p> <p>⚠ Be sure to process the board in accordance with the process drawing.</p>	<b>Possibility of automatic placement</b>									
	<table border="1"> <thead> <tr> <th>Construction Type</th> <th>Unsealed</th> <th>Flux protection</th> <th>Fully sealed</th> </tr> </thead> <tbody> <tr> <td>Stick packaged type</td> <td>No</td> <td>Yes</td> <td>Yes</td> </tr> </tbody> </table>	Construction Type	Unsealed	Flux protection	Fully sealed	Stick packaged type	No	Yes	Yes	
Construction Type	Unsealed	Flux protection	Fully sealed							
Stick packaged type	No	Yes	Yes							

Process 2
Flux application

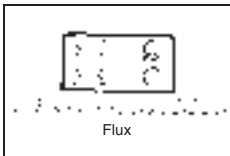

<p>① To apply flux to a flux protected or fully sealed relay, a sponge soaked with flux can be used. Place the relay in the holes drilled in the board and press the board (with relay still mounted) firmly against the sponge. The flux will be pushed up the relay's contact legs, and through the board holes. This method must never be applied with unsealed relays because the flux will penetrate the relay. Be careful not to use too much pressure to avoid flux intrusion into flux protected relays (not fully sealed.)</p> <p>⚠ The flux used with the sponge must be a non-corrosive resin type flux. For the flux solvent, use an alcohol-based solvent, which tends to be less chemically reactive. Apply the flux sparingly and evenly to prevent penetration into the relay. When dipping the relay terminals into liquid flux, be sure to adjust the flux level, so that the upper surface of the board is not flooded with flux.</p> <p>③ Flux must not be on any other area except the relay terminals. Insulation deterioration might occur if flux is applied on the bottom of the relay, etc.</p>	<p>Push strongly</p> <p>Relay Board Sponge with flux</p> <p>Bad example</p>							
	<p><b>Possibility of dipping method</b></p> <table border="1"> <thead> <tr> <th>Unsealed</th> <th>Flux protection</th> <th>Simple plastic seal</th> </tr> </thead> <tbody> <tr> <td>No</td> <td>Yes (Necessary to check when a spray fluxer is used.)</td> <td>Yes</td> </tr> </tbody> </table>			Unsealed	Flux protection	Simple plastic seal	No	Yes (Necessary to check when a spray fluxer is used.)
Unsealed	Flux protection	Simple plastic seal						
No	Yes (Necessary to check when a spray fluxer is used.)	Yes						

Process 3
Preheating

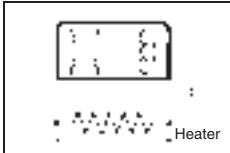

<p>Preheat the board to a temperature of 100°C maximum within a period of approximately one minute for smooth soldering. The characteristics of the relay may change if it is heated to a high temperature for a long time.</p>	<b>Possibility of preheating</b>							
	<table border="1"> <thead> <tr> <th>Unsealed</th> <th>Flux protection</th> <th>Simple plastic seal</th> </tr> </thead> <tbody> <tr> <td>No</td> <td>Yes</td> <td>Yes</td> </tr> </tbody> </table>	Unsealed	Flux protection	Simple plastic seal	No	Yes	Yes	
Unsealed	Flux protection	Simple plastic seal						
No	Yes	Yes						

Process 4
Soldering

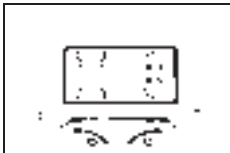

Automatic soldering	Manual soldering												
<p>① Wave soldering is recommended to assure a uniform solder joint.</p> <ul style="list-style-type: none"> <li>• Soldering temperature: About 260°C</li> <li>• Soldering time: within 5sec</li> <li>• Adjust the level of the molten solder so that the board is not flooded with solder.</li> </ul> <p><b>Possibility of automatic soldering</b></p> <table border="1"> <thead> <tr> <th>Unsealed</th> <th>Flux protection</th> <th>Simple plastic seal</th> </tr> </thead> <tbody> <tr> <td>No</td> <td>Yes</td> <td>Yes</td> </tr> </tbody> </table>	Unsealed	Flux protection	Simple plastic seal	No	Yes	Yes	<p>① Solder with the following conditions flattening a soldering iron tip.</p> <ul style="list-style-type: none"> <li>• Soldering iron: rated at 30 to 60 W</li> <li>• Soldering iron temperature: 350°C</li> <li>• Soldering time: within 3 sec</li> </ul> <p>⚠ The solder in the illustration shown above is provided with a cut section to prevent the flux from splattering.</p> <p>Solder Flux</p> <p><b>Possibility of manual soldering</b></p> <table border="1"> <thead> <tr> <th>Unsealed</th> <th>Flux protection</th> <th>Simple plastic seal</th> </tr> </thead> <tbody> <tr> <td>Yes</td> <td>Yes</td> <td>Yes</td> </tr> </tbody> </table>	Unsealed	Flux protection	Simple plastic seal	Yes	Yes	Yes
Unsealed	Flux protection	Simple plastic seal											
No	Yes	Yes											
Unsealed	Flux protection	Simple plastic seal											
Yes	Yes	Yes											

To next page

# Safety Precautions for All Automotive Relays

## Process 5 Cooling

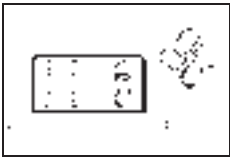

① Upon completion of automatic soldering, use a fan or other devices to cool the board. This helps protect the relay and other components from deterioration from the residual heat of soldering.

⚠ Fully sealed relays are washable. However, do not put fully sealed relays in a cold cleaning solvent immediately after soldering. The seal may be damaged by thermal shock.

### Cooling

Flux protection	Simple plastic seal
Necessary	Necessary

## Process 6 Cleaning

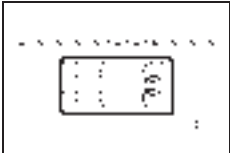

Refer to the list below for the selection of the cleaning method and solvent.

### ① Cleaning method

Unsealed	Flux protection	Simple plastic seal
Boiling cleaning and immersion cleaning are not acceptable. Use a brush to clean the back of the board.		Boiling cleaning and immersion cleaning are acceptable. Do not perform ultrasonic cleaning (except on relays manufactured specifically for ultrasonic cleaning.) Internal or external physical damage to the relay may result causing undesirable performance or relay failure. The cleaning solvent temperature shall be within the permissible service temperature range of the relay.

### ② List of cleaning solvents

Solvent	Simple plastic seal
Chlorine-based: pero-chlene, chlorosolder, purified (hot) water	Acceptable
Water-based: indusco, holys, purified water	Acceptable
Alcohol-based: IPA, ethanol	Acceptable
Others: thinner, gasoline	Unacceptable

Note 1. Consult your Omron representative before using any other cleaning solvents. Do not use Freon-TMC-based, thinner-based or gasoline-based cleaning solvents.

Note 2. It may be difficult to clean the space between the relay and the board by using hydrogen-based or alcohol-based cleaning solvents. It is recommended that a stand-off type relay be used in such cases.

Worldwide efforts are being made at discontinuing the use of CFC-113-based (chlorofluorocarbon-based) and trichloroethylene-based cleaning solvents. Please refrain from using these cleaning solvents.

## Process 7 Coating

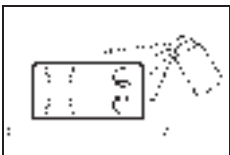

① Do not apply a coating agent to any non-sealed relay because the coating agent will penetrate into the relay and the contacts may be damaged.

⚠ Some coating agents may damage the case of the relay. Be sure to use a proper coating agent.

③ Do not fix the position of the relay with resin or the characteristics of the relay may change. Coating agent temperature shall be within the permissible ambient operating temperature range of the relay.

### Coating

Resin	Simple plastic seal
Epoxy	Yes
Urethane	Yes
Silicone	No
Fluorine	Yes

# Safety Precautions for All Automotive Relays

## @Surface Mounting

When mounting Relays to PCBs, consider the following information at each point in the process and set the solder reflow conditions accordingly. Refer to the pages for individual Relay models for mounting precautions that are specific to the individual models.



### Process 1 Cream solder printing

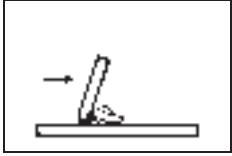

- Do not use a cream solder that contains a flux with a large amount of chlorine or the terminals of the relay or PCB traces may become corroded. A rosin type solder with little or no chlorine is recommended.

### Process 2 Relay mounting

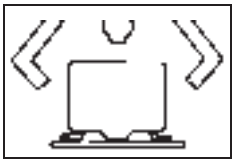

- The holding force of the relay holder shall be the same as or less than the reference value for each relay.

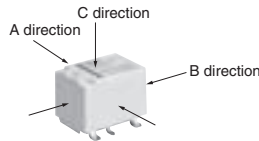

	G8FE	G8FD
<b>A direction</b>	1.96 N max.	1.96 N max.
<b>B direction</b>	4.9 N max.	4.9 N max.
<b>C direction</b>	1.96 N max.	1.96 N max.

### Process 3 Transportation

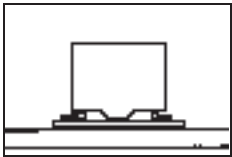

- The relay may move or become "un-mounted" as a result of vibration during transportation which can then result in soldering defects.

### Process 4 Reflow soldering

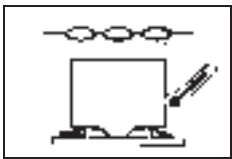

IRS (infrared reflow soldering)	
Mounting with lead solder	Mounting with lead-free solder
<ul style="list-style-type: none"> <li>The recommended soldering conditions are shown by the temperature profile of the PCB surface. The conditions, however, vary with the model of the Relay. Confirm specifications for the individual models. (Refer to the safety precautions section for each model.)</li> <li>Do not place the Relay in a cleaning solvent or other cold liquid immediately after soldering. The seal of the relay may be damaged.</li> </ul>	<ul style="list-style-type: none"> <li>The recommended soldering conditions are shown by the temperature profile of the Relay terminal pins. The conditions, however, vary with the model of the Relay. Confirm specifications for the individual models. (Refer to the safety precautions section for each model.)</li> <li>Do not put the Relay in a cleaning solvent or other cold liquid immediately after soldering. The seal of the relay may be damaged.</li> </ul>
<p>Recommended Conditions</p>	<p>Recommended Conditions</p>

Note: Do not dip the Relay into the solder bath. Doing so may cause malfunction due to plastic deformation.

To next page

# Safety Precautions for All Automotive Relays

Process 5
Cleaning

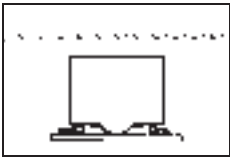

- When cleaning connections after reflow-solder mounting, use an alcohol-based or water-based cleaner. Also, make sure that the cleaning temperature is 40°C or lower.
- We recommend boiling or immersion cleaning when cleaning the entire Relay. Do not perform ultrasonic cleaning. Doing so can cause breaks in the coil or minor welding of the contacts.

List of cleaning solvents







Solvent	Simple plastic seal
Chlorine-based: perchlene, chlorosolder	Acceptable
Water-based: indusco, holys, purified (hot) water	Acceptable
Alcohol-based: IPA, ethanol	Acceptable
Others: thinner, gasoline	Unacceptable

Note 1. Consult your Omron representative before using any other cleaning solvents. Do not use Freon-TMC-based, thinner-based cleaning solvents.

Note 2. It may be difficult to clean the space between the relay and the board by using hydrogen-based or alcohol-based cleaning solvents. It is recommended that a stand-off type relay be used in such cases.

Worldwide efforts are being made at discontinuing the use of CFC-113-based (chlorofluorocarbon-based) and trichloroethylene-based cleaning solvents. Please refrain from using these cleaning solvents.

## (7) Terminal Shape

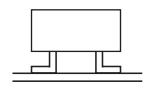
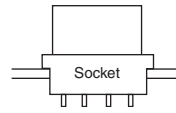
Classification	Terminal for PCB	Surface mount terminal for PCB	Plug-in terminal
Model	 G8NB G8FD G8ND G8QE G8FE G8HL	 G8FD G8FE	 G8HL G8HN-J G8JN G8JR G8HE G8VA G8V G8V-RH G8W
Terminal shape			
Mounting			

## (8) Protection Construction

### ① Protection Construction

To prevent contact failure and other problems, a suitable relay protection construction must be selected for the application environment and the mounting conditions.

Refer to the protection constructions in the following table, and select a suitable relay.

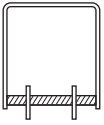
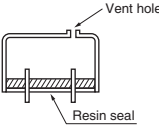
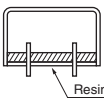
Type	Protection construction		Automatic soldering	Automatic cleaning	Ambience	
	Construction	Features			Penetration of dust	Penetration of gas
Unsealed *IEC61810 RT1		The relay is in the case to prevent contact with foreign matters.	Poor	Poor	Fair	Poor
Flux protection (Open vent hole) *IEC61810 RT2		Terminals are sealed. Or molding is performed at the same time.	Good	Poor	Fair	Poor
Simple plastic seal *IEC61810 RT3		Terminal, case and base are sealed. Flux or cleaning solvent does not penetrate.	Good	Good	Good	Good

### ② Using Relays in Atmospheres Subject to Dust

If a Relay is used in an atmosphere subject to dust, dust will enter the Relay, become lodged between contacts, and cause the circuit to fail to close. Moreover, if conductive material such as wire clippings enter the Relay, it will cause contact failure and short-circuiting.

### ③ Exporting to Tropical Zones

Use the following types of Relays if they are to be exported to tropical zones.

- High-humidity Relays
- Simple plastic sealed Relays
- Hermetically Sealed Relays

Using other types of Relays may result in operating problems because of rusted metal parts.

# G8NB

Automotive PCB relay (Single)/(Twin)

G8NB has been designed to correspond with various kinds of automotive application as the successor to the G8N series.



- Compatible terminal pitch with G8N series (except the height).
- Reliable contacts and conducting material have achieved a high carry current capability (20% improved compare to G8N)
- Correspond to the reflow soldering. (Open vent hole type)
- Twin type (2 relays in 1 case) is available. (Independent 2 circuits)

## ■ Purpose

- DC motor control for automotive parts (Door lock motor, Power window motor, Wiper motor, Washer motor, Sunroof motor, etc.)

## ■ Type standard

G8NB-□□□□

① ② ③ ④

	Classification	Symbol	Meaning of the symbol
①	Number of contact poles/Structure	1	1c contact (SPDT)
		2	1cx2 contacts (SPDT×2)
②	Protective structure	Blank	Simple plastic seal
		7	Flux protection (Open vent hole)
③	Characteristics	Blank	Standard
		S	Low operating voltage
		U	Ultralow operating voltage
④	Special specification	Blank	Standard
		R	High heat resistance

## ■ Classification

Classification	Terminal form	Contact structure	Protective structure	Rated coil		Type	Characteristics
				Voltage (V)	Resistance (Ω)		
Single	PCB terminal	SPDT (1c)	Simple plastic seal	DC12	225	<b>G8NB-1</b>	Standard
					180	<b>G8NB-1S</b>	Low operating voltage
					130	<b>G8NB-1U</b>	Super low operating voltage
			Flux protection (Open vent hole)		225	<b>G8NB-17R</b>	Standard
					180	<b>G8NB-17SR</b>	Low operating voltage
					130	<b>G8NB-17UR</b>	Super low operating voltage
Twin	PCB terminal	SPDT X 2 (1c×2)	Simple plastic seal		225	<b>G8NB-2</b>	Standard
					180	<b>G8NB-2S</b>	Low operating voltage
					130	<b>G8NB-2U</b>	Super low operating voltage
			Flux protection (Open vent hole)		225	<b>G8NB-27R</b>	Standard
					180	<b>G8NB-27SR</b>	Low operating voltage
					130	<b>G8NB-27UR</b>	Super low operating voltage

## ■ Ratings

### ● Operation coil

Rated voltage (V)	Coil resistance (Ω)	Rated current (mA)	Operating voltage (V)	Release voltage (V)	Max. of applied voltage (5A conduct, 105°C) (V)	Service voltage range (V)	Rated power consumption (mW)
DC 12	225	53.3	7.2 or less	1.0 or more	DC16, continuous	DC10 to 16	640
	180	66.7	6.5 or less		DC16, 15 min.		800
	130	92.3	5.5 or less	0.8 or more	DC14, continuous DC16, 3 min.		1108

### ● Switching area

Item	Performance	
Contact material	Silver alloy	
Rated voltage	DC12V	
Rated load	Motor load, 25A	
Inrush current	30A	
Continuous carry current <sup>*1</sup>	5A	
Allowable carrying current	30A at DC14V (30 min.) <sup>*2</sup>	(Reference)
Min. Carry / Switching Current	DC12V 1A	

## ■ Performance

Item	Standard value	
	G8NB-1	G8NB-2
Contact resistance <sup>*3</sup>	50mΩ or less	
Operating time <sup>*4</sup>	10ms or less	
Release time <sup>*4</sup>	5ms or less	
Insulation resistance <sup>*5</sup>	Between coil and terminal	100MΩ or more
	Between homopolar contacts	100MΩ or more
Withstand voltage <sup>*6</sup>	Between coil and terminal	AC500V for 1min.
	Between homopolar contacts	AC500V for 1min.
Vibration resistance	Durability	33Hz 45m/s <sup>2</sup>
	Malfuction (Detecting time: 1ms)	10 to 400Hz 45m/s <sup>2</sup>
Shock resistance	Durability	1000m/s <sup>2</sup> (Operating time:6ms)
	Malfuction (Detecting time: 1ms)	100m/s <sup>2</sup> (Operating time:11ms)
Mechanical endurance (Switching frequency:18,000 times/h)	1,000,000 times	
Electrical endurance (Rated load)	100,000 times	
Ambient temperature	-40 to 105°C	
Ambient humidity	35 to 85%RH	
Weight	4g	8g

## ■ Packing

Type	G8NB-1	G8NB-2
Packing form	Stick	
MOQ <sup>*7</sup>	2,700pcs (75pcs×36sticks)	1,260pcs (35pcs×36sticks)

Note: All values above are measured in early time under an ambient temperature of +20°C and humidity of 65% unless stated.

- \*1. The value stated is at maximum temperature in a guaranteed ambient temperature.
- \*2. This is an acceptable current-carrying value in abnormal, and this is not a value which guarantee a repeat current-carrying. Please check under actual use condition before use.
- \*3. Measured with a voltage drop method at DC5V 1A.
- \*4. It changes depend on how the rated voltage is operated, but bounce-time is not included.
- \*5. Measured at DC500V.
- \*6. Measured under 1mA of leak current, 50/60Hz for 1minute.
- \*7. Minimum Order Quantity is subject to change, please feel free to contact our sales representatives.

## ■ Dimensions (Unit: mm)

### G8NB-1

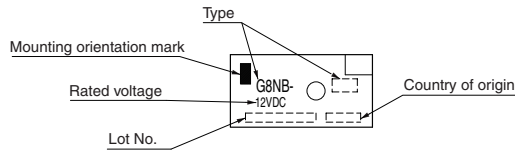

PWB processing dimension  
(BOTTOM VIEW)

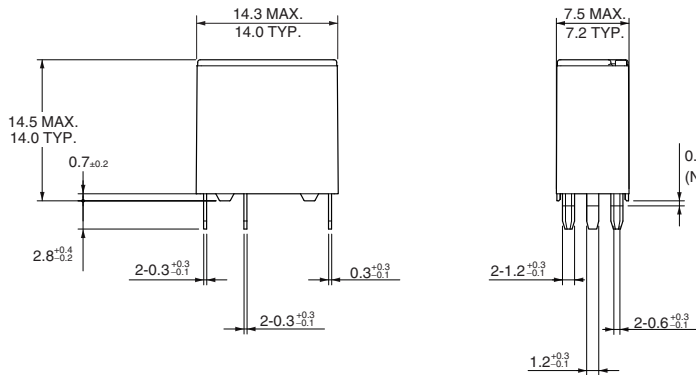
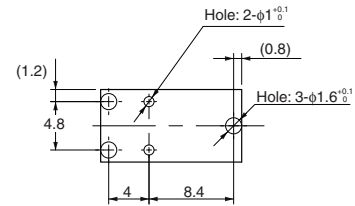

Terminal arrangement /  
Internal connections  
(BOTTOM VIEW)

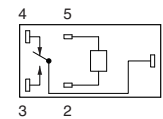

### G8NB-2

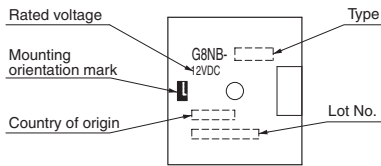

PWB processing dimension  
(BOTTOM VIEW)

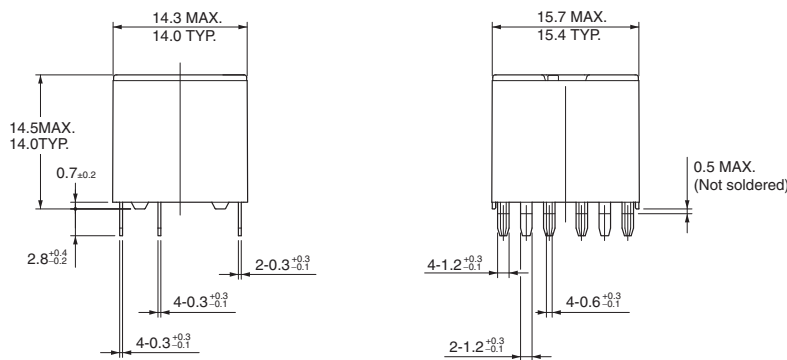
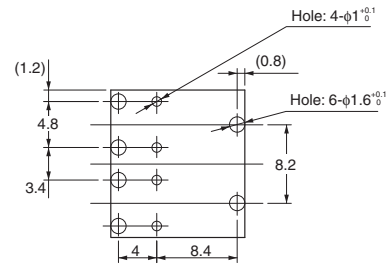

Terminal arrangement /  
Internal connections  
(BOTTOM VIEW)

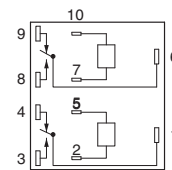

\* Tolerance unless otherwise specified  
Less than 1 mm: ±0.1 mm  
Less than 1 to 3 mm: ±0.2 mm  
3 mm or more: ±0.3 mm