

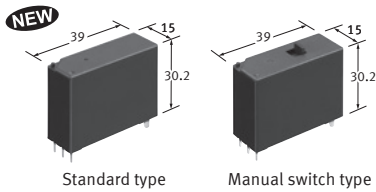

Suitable for lighting and motor load, 1 Form A 50A latching relays

DJ-H RELAYS (ADJH)

Protective construction : Flux-resistant type



(Unit : mm)

FEATURES

- High inrush capability
 - Tungsten load (TV-20 class)
 - Electronic ballast load (NEMA410)
 - Capacitive load (IEC60669-1)
- Supports manual operation
 - Manual switch type available

TYPICAL APPLICATIONS

- Smart house (Shutter and Sunblind control)
- Lighting control

ORDERING INFORMATION

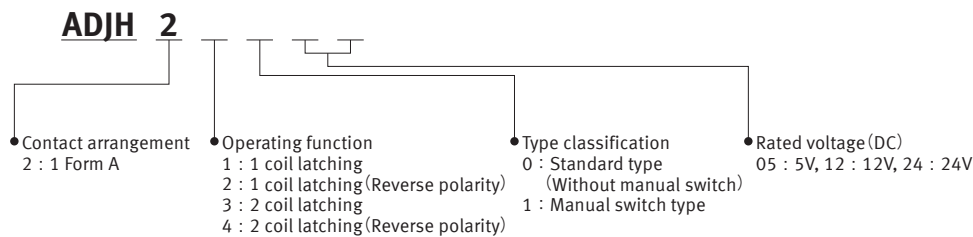

TYPES

1. Standard type (Without manual switch)

Contact arrangement	Rated voltage	Part No.		Standard packing	
		1 coil latching type	2 coil latching type	Carton	Case
1 Form A	5V DC	ADJH21005	ADJH23005	50 pcs.	200 pcs.
	12V DC	ADJH21012	ADJH23012		
	24V DC	ADJH21024	ADJH23024		

*Reverse polarity type available. (1 coil latching type: ADJH220**, 2 coil latching type: ADJH240**)

2. Manual switch type

Contact arrangement	Rated voltage	Part No.		Standard packing	
		1 coil latching type	2 coil latching type	Carton	Case
1 Form A	5V DC	ADJH21105	ADJH23105	50 pcs.	200 pcs.
	12V DC	ADJH21112	ADJH23112		
	24V DC	ADJH21124	ADJH23124		

*Reverse polarity type available. (1 coil latching type: ADJH221**, 2 coil latching type: ADJH241**)

RATING

1. Coil data

- Operating characteristics such as 'Operate voltage' and 'Release voltage' are influenced by mounting conditions, ambient temperature, etc. Therefore, please use the relay within $\pm 5\%$ of rated coil voltage.
- 'Initial' means the condition of products at the time of delivery.

1) 1 coil latching type

Rated voltage	Set voltage (at 20°C 68°F)*1	Reset voltage (at 20°C 68°F)*1	Rated operating current [$\pm 10\%$] (at 20°C 68°F)		Coil resistance [$\pm 10\%$] (at 20°C 68°F)		Rated operating power	Max. allowable voltage (at 20°C 68°F)
			Set coil	Reset coil	Set coil	Reset coil		
5V DC	Max. 75% or less of rated voltage (Initial)	Max. 75% or less of rated voltage (Initial)	200 mA	200 mA	25Ω	25Ω	1,000mW	130% of rated voltage
12V DC			83.3mA	83.3mA	144Ω	144Ω		
24V DC			41.7mA	41.7mA	576Ω	576Ω		

*1. Square, pulse drive

2) 2 coil latching type

Rated voltage	Set voltage (at 20°C 68°F)*1	Reset voltage (at 20°C 68°F)*1	Rated operating current [$\pm 10\%$] (at 20°C 68°F)		Coil resistance [$\pm 10\%$] (at 20°C 68°F)		Rated operating power	Max. allowable voltage (at 20°C 68°F)
			Set coil	Reset coil	Set coil	Reset coil		
5V DC	Max. 75% or less of rated voltage (Initial)	Max. 75% or less of rated voltage (Initial)	400 mA	400 mA	12.5Ω	12.5Ω	2,000mW	130% of rated voltage
12V DC			166.7mA	166.7mA	72 Ω	72 Ω		
24V DC			83.3mA	83.3mA	288 Ω	288 Ω		

*1. Square, pulse drive

2. Specifications

Characteristics	Item	Specifications
Contact data	Arrangement	1 Form A
	Contact resistance (initial)	Max. 20 mΩ (by voltage drop 24 V DC 1A)
	Contact material	AgSnO ₂ type
	Contact rating (resistive)	50A 277V AC
	Max. switching power (resistive)	13,850 VA (50A 277V AC)
	Max. switching voltage	480V AC
	Max. switching current	50A (AC)
	Min. switching load (reference value)*1	100mA 5 V DC
Insulation resistance (initial)		Min. 1,000MΩ (at 500V DC) Measured portion is the same as the case of dielectric voltage
Dielectric strength (initial)	Between open contacts	1,500 Vrms for 1min. (Detection current: 10mA)
	Between contact and coil	4,000 Vrms for 1min. (Detection current: 10mA)
Surge withstand voltage*2 (initial)	Between contact and coil	12,000 V
Set time (initial)		Max. 20ms (at rated voltage, at 20°C 68°F, without bounce)
Reset time (initial)		Max. 20ms (at rated voltage, at 20°C 68°F, without bounce)
Shock resistance	Functional	100 m/s ² (half-sine shock pulse: 11 ms, detection time: 10μs)
	Destructive	1,000 m/s ² (half-sine shock pulse: 6 ms)
Vibration resistance	Functional	10 to 55 Hz at double amplitude of 1.5 mm (detection time: 10μs)
	Destructive	10 to 55 Hz at double amplitude of 2.0 mm
Expected life	Mechanical	Min. 1×10 ⁶ (at 180 times/min.)
Conditions	Conditions for operation, transport and storage*3	Ambient Temperature: -40 to +85°C -40 to +185°F Humidity: 5 to 85% R.H. (Not freezing and condensing at low temperature)
Unit weight		Approx. 31 g 1.09 oz

Notes: *1. Minimum switching load is a guide to the lower current limit of switching under the micro-load. This parameter is changed by the condition, such as switching times, environment condition, and expected reliability. When the relay is used lower than minimum switching load, reliability is attrition. Please use the relay over minimum switching load.

*2. Wave is standard shock voltage of $\pm 1.2 \times 50\mu\text{s}$ according to JEC-212-1981

*3. Allowable range when in original packaging is -40 to +70°C -40 to +158°F.

3. Expected electrical life

Type	Load	Switching capacity	Number of operations	
1 Form A	Resistive	50A 277V AC	Min. 1 × 10 ⁴ (ON:OFF = 1s:9s)	
		25A 277V AC	Min. 1 × 10 ⁵ (ON:OFF = 1s:9s)	
	Inrush load	Tungsten	2,400W 120V AC	Min. 2.5 × 10 ⁴ (ON:OFF = 1s:59s)
		Electronic ballast	20A 277V AC	Min. 6 × 10 ³ (ON:OFF = 1s:9s)
		Capacitive (IEC 60669-1)	20A 250V AC 200μF	Min. 3 × 10 ⁴ (ON:OFF = 1s:9s)

4. Inrush load (Electrical life diagram)

Load	Tungsten	Electronic ballast	Capacitive (IEC 60669-1)
Switching capacity	2,400W 120V AC	20A 277V AC	20A 250V AC 200 μ F
Load voltage	120V AC (60Hz)	277V AC (60Hz)	250V AC (60Hz)
Load current	Inrush 250A _{OP} Steady-state 20Arms	Inrush 480A _{OP} Steady-state 16Arms	Inrush 400A _{OP} Steady-state 20Arms
Circuit			
Current waveform			

DJ-H (ADJH2)

DIMENSIONS (mm)

1. Standard type (Without manual switch)

CAD



External dimensions

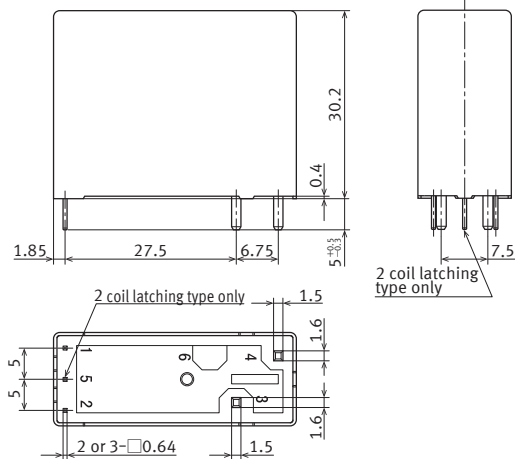
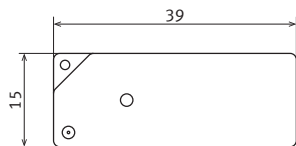

General tolerance ± 0.3

CAD The CAD data of the products with a "CAD" mark can be downloaded from our Website.

PC board pattern (Bottom view)

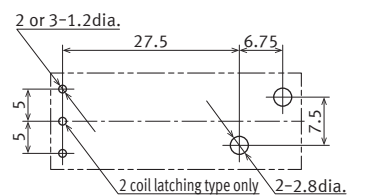

Tolerance ± 0.1

Schematic (Bottom view)

1 coil latching type

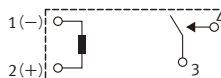

2 coil latching type

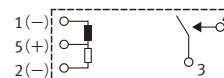

1 coil latching type
(Reverse polarity)

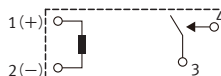

2 coil latching type
(Reverse polarity)

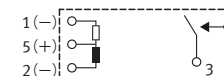

2. Manual switch type

CAD



External dimensions

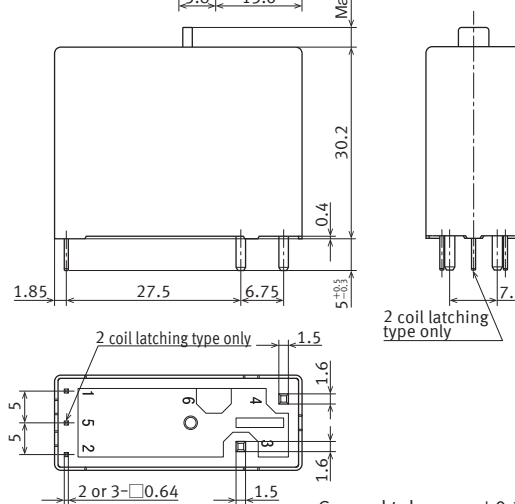
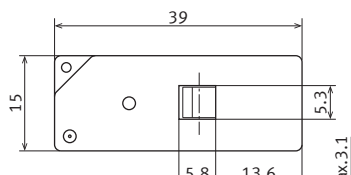

General tolerance ± 0.3

PC board pattern (Bottom view)

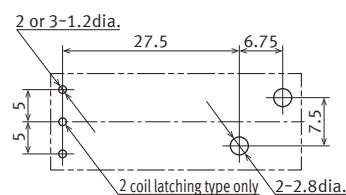

Tolerance ± 0.1

Schematic (Bottom view)

1 coil latching type

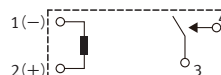

2 coil latching type

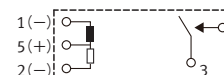

1 coil latching type
(Reverse polarity)

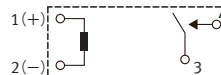

2 coil latching type
(Reverse polarity)

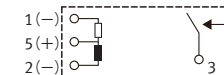

SAFETY STANDARDS

UL/C-UL (Recognized)				VDE			
File No.	Contact rating	Cycles	Temperature	File No.	Contact rating	Cycles	Temperature
E43149	50A 277V AC Resistive	10 ⁴	85°C 185°F	40045659	50A 250V AC (cosφ = 1.0)	10 ⁴	85°C 185°F
	40A 347V AC Resistive	2 × 10 ⁴	40°C 104°F				
	30A 480V AC Resistive	2 × 10 ⁴	40°C 104°F				
	20A 347V AC Electronic ballast (1 coil latching type only)	6 × 10 ³	40°C 104°F				
	20A 277V AC Electronic ballast	6 × 10 ³	85°C 185°F		25A 250V AC (cosφ = 1.0)	9 × 10 ⁴	40°C 104°F
	20A 277V AC Standard ballast	3 × 10 ⁴	85°C 185°F				
	15A 347V AC Standard ballast	3 × 10 ⁴	85°C 185°F				
	5,540W 277V AC Tungsten	2.5 × 10 ⁴	40°C 104°F				
					20A 250V AC Capacitor 200μF (IEC60669-1 compliant)	5 × 10 ³	40°C 104°F

INSULATION CHARACTERISTICS (IEC61810-1)

Item	Characteristics
Clearance/Creepage distance (IEC61810-1)	9.5mm/12.7mm
Category of protection (IEC61810-1)	RT II
Tracking resistance (IEC60112)	175V
Insulation material group	III a
Over voltage category	III
Rated voltage	250 V
Pollution degree	2
Type of insulation (Between contact and coil)	4,000 V
Type of insulation (Between open contacts)	1,500 V

NOTES

1. For cautions for use, please read "GENERAL APPLICATION GUIDELINES".
2. Regarding the set/reset pulse time of the latching type relay, it is recommended to apply rated voltage for minimum 100ms pulse across the coil to secure the sure operation considering the ambient temperature and condition change through service life.

Please refer to "**the latest product specifications**" when designing your product.

- Requests to customers :
<https://industrial.panasonic.com/ac/e/salespolicies/>

GUIDELINES FOR POWER RELAYS AND HIGH-CAPACITY DC CUT OFF RELAYS USAGE

For cautions for use, please read “GUIDELINES FOR RELAY USAGE”.

https://industrial.panasonic.com/ac/e/control/relay/cautions_use/index.jsp

Precautions for Coil Input

■ Long term current carrying

A circuit that will be carrying a current continuously for long periods without relay switching operation. (circuits for emergency lamps, alarm devices and error inspection that, for example, revert only during malfunction and output warnings with form B contacts) Continuous, long-term current to the coil will facilitate deterioration of coil insulation and characteristics due to heating of the coil itself.

For circuits such as these, please use a magnetic-hold type latching relay. If you need to use a single stable relay, use a sealed type relay that is not easily affected by ambient conditions and make a failsafe circuit design that considers the possibility of contact failure or disconnection.

■ DC Coil operating power

Steady state DC current should be applied to the coil. The wave form should be rectangular. If it includes ripple, the ripple factor should be less than 5%.

However, please check with the actual circuit since the electrical characteristics may vary. The rated coil voltage should be applied to the coil and the set/reset pulse time of latching type relay differs for each relays, please refer to the relay's individual specifications.

■ Coil connection

When connecting coils of polarized relays, please check coil polarity (+,-) at the internal connection diagram (Schematic). If any wrong connection is made, it may cause unexpected malfunction, like abnormal heat, fire and so on, and circuit do not work. Avoid impressing voltages to the set coil and reset coil at the same time.

Ambient Environment

● Usage, Transport, and Storage Conditions

During usage, storage, or transportation, avoid locations subjected to direct sunlight and maintain normal temperature, humidity and pressure conditions.

● Temperature/Humidity/Pressure

When transporting or storing relays while they are tube packaged, there are cases the temperature may differ from the allowable range. In this case be sure to check the individual specifications. Also allowable humidity level is influenced by temperature, please check charts shown below and use relays within mentioned conditions. (Allowable temperature values differ for each relays, please refer to the relay's individual specifications.)

1) Temperature:

The tolerance temperature range differs for each relays, please refer to the relay's individual specifications

2) Humidity:

5 to 85 % RH

3) Pressure:

86 to 106 kPa

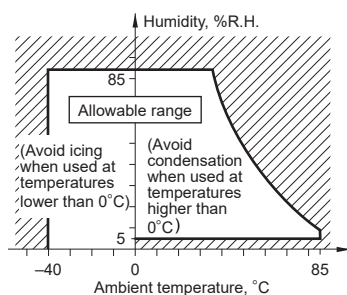

■ Maximum allowable voltage and temperature rise

Proper usage requires that the rated coil voltage be impressed on the coil. Note, however, that if a voltage greater than or equal to the maximum continuous voltage is impressed on the coil, the coil may burn or its layers short due to the temperature rise. Furthermore, do not exceed the usable ambient temperature range listed in the catalog.

■ Operate voltage change due to coil temperature rise (Hot start)

In DC relays, after continuous passage of current in the coil, if the current is turned OFF, then immediately turned ON again, due to the temperature rise in the coil, the pick-up voltage will become somewhat higher. Also, it will be the same as using it in a higher temperature atmosphere. The resistance/temperature relationship for copper wire is about 0.4% for 1°C, and with this ratio the coil resistance increases. That is, in order to operate of the relay, it is necessary that the voltage be higher than the pick-up voltage and the pick-up voltage rises in accordance with the increase in the resistance value. However, for some polarized relays, this rate of change is considerably smaller.

● Dew condensation

Condensation occurs when the ambient temperature drops suddenly from a high temperature and humidity, or the relay is suddenly transferred from a low ambient temperature to a high temperature and humidity. Condensation causes the failures like insulation deterioration, wire disconnection and rust etc. Panasonic Corporation does not guarantee the failures caused by condensation.

The heat conduction by the equipment may accelerate the cooling of device itself, and the condensation may occur.

Please conduct product evaluations in the worst condition of the actual usage. (Special attention should be paid when high temperature heating parts are close to the device. Also please consider the condensation may occur inside of the device.)

● Icing

Condensation or other moisture may freeze on relays when the temperature become lower than 0°C. This icing causes the sticking of movable portion, the operation delay and the contact conduction failure etc. Panasonic Corporation does not guarantee the failures caused by the icing.

The heat conduction by the equipment may accelerate the cooling of relay itself and the icing may occur. Please conduct product evaluations in the worst condition of the actual usage.

● Low temperature and low humidity

The plastic becomes brittle if the switch is exposed to a low temperature, low humidity environment for long periods of time.

● High temperature and high humidity

Storage for extended periods of time (including transportation periods) at high temperature or high humidity levels or in atmospheres with organic gases or sulfide gases may cause a sulfide film or oxide film to form on the surfaces of the contacts and/or it may interfere with the functions. Check out the atmosphere in which the units are to be stored and transported.

GUIDELINES FOR POWER RELAYS AND HIGH-CAPACITY DC CUT OFF RELAYS USAGE

●Package

In terms of the packing format used, make every effort to keep the effects of moisture, organic gases and sulfide gases to the absolute minimum.

●Silicon

When a source of silicone substances (silicone rubber, silicone oil, silicone coating materials and silicone filling materials etc.) is used around the relay, the silicone gas (low molecular siloxane etc.) may be produced.

This silicone gas may penetrate into the inside of the relay. When the relay is kept and used in this condition, silicone compound may adhere to the relay contacts which may cause the contact failure. Do not use any sources of silicone gas around the relay (Including plastic seal types).

●NOx Generation

When relay is used in an atmosphere high in humidity to switch a load which easily produces an arc, the NOx created by the arc and the water absorbed from outside the relay combine to produce nitric acid. This corrodes the internal metal parts and adversely affects operation. Avoid use at an ambient humidity of 85%RH or higher (at 20°C). If use at high humidity is unavoidable, please contact our sales representative.

Others

■Cleaning

- 1) Although the environmentally sealed type relay (plastic sealed type, etc.) can be cleaned, avoid immersing the relay into cold liquid (such as cleaning solvent) immediately after soldering. Doing so may deteriorate the sealing performance.
- 2) Cleaning with the boiling method is recommended(The temperature of cleaning liquid should be 40°C or lower).
Avoid ultrasonic cleaning on relays. Use of ultrasonic cleaning may cause breaks in the coil or slight sticking of the contacts due to ultrasonic energy.

Please refer to "**the latest product specifications**" when designing your product.

•Requests to customers:

<https://industrial.panasonic.com/ac/e/salespolicies/>

Please contact

Panasonic Corporation

Electromechanical Control Business Division

■ 1006, Oaza Kadoma, Kadoma-shi, Osaka 571-8506, Japan
industrial.panasonic.com/ac/e/

Panasonic[®]

©Panasonic Corporation 2019