

High-Speed Data Connector System

## RosenbergerHSD<sup>®</sup> Connectors

AUTOMOTIVE

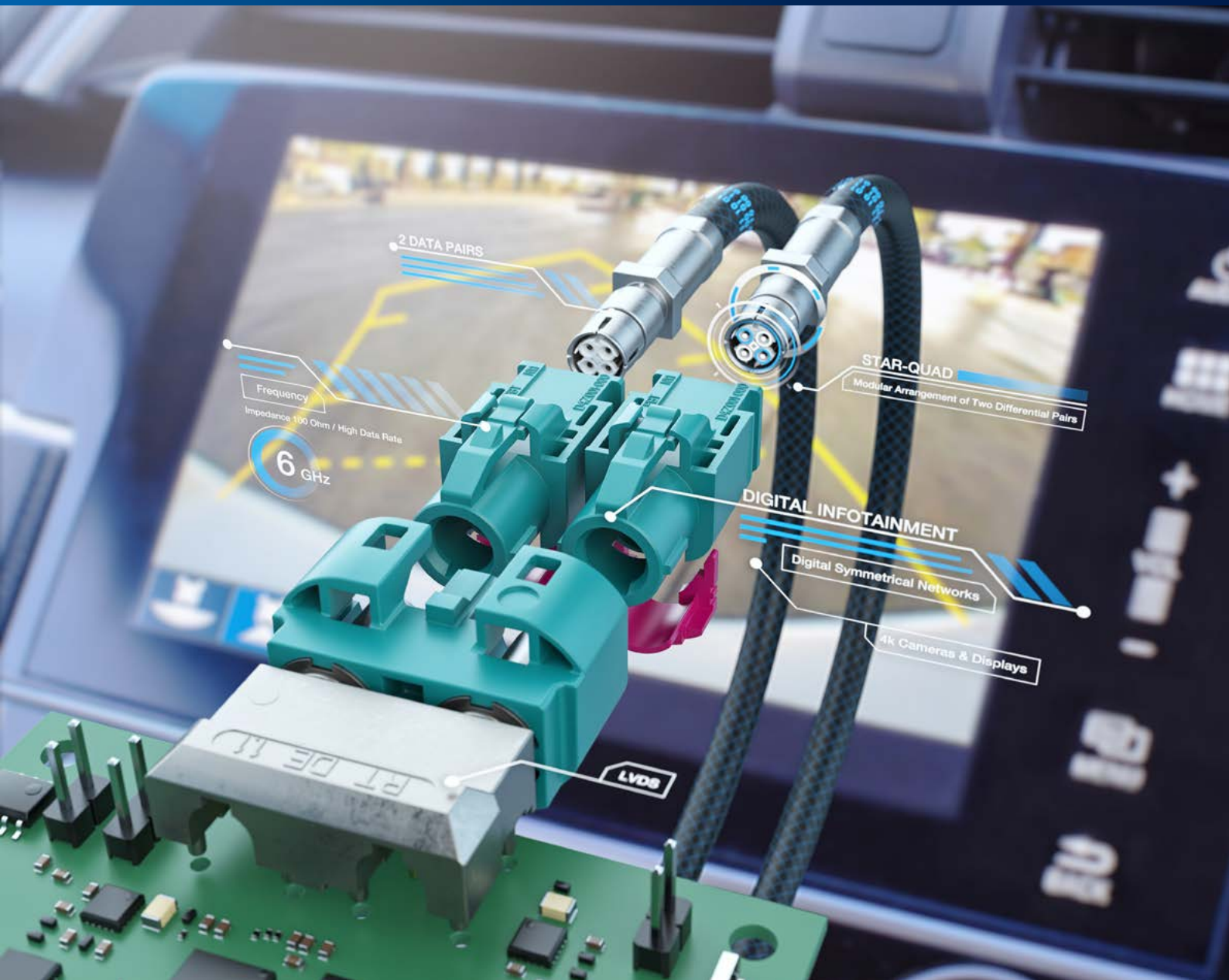



## Rosenberger Automotive – A Synonym for Quality and Innovation

On the following pages we present the high-quality RosenbergHSD® connectors developed in our Automotive Business Area to fulfill the tough requirements of the automotive industry.

Rosenberger Global Network	4
Quality & Environment	6
Competencies & Technology	8
Research & Development	10
Rosenberger Automotive	12
RosenbergerHSD® Product Overview	14
RosenbergerHSD® Number Codes	16
RosenbergerHSD® Codings	18
RosenbergerHSD® Technical Data	24
RosenbergerHSD® Connectors	26
PCB Connectors – Wave Soldering	26
PCB Connectors – Pin-in-Paste	27
Cable Connectors	30
Cable Connectors – Waterproof	32
RosenbergerHSD®+ Power Pin Connectors	34
RosenbergerHSD®t Technical Data	38
RosenbergerHSD®t Connectors	40
Cable Connectors	41
Waterproof Connectors	42
Test Components & Tools	44
Cable Assemblies	46
Technical References	58
Index	90



The Rosenberger online catalog contains the current RosenbergerHSD® product range with specific details, including data sheets, assembly instructions, and panel piercings.

[www.rosenberger.com/ok/hsd](http://www.rosenberger.com/ok/hsd)



# Rosenberger Global Network

Rosenberger is one of the world's leading manufacturers of impedance controlled and optical connectivity solutions. It provides connectivity solutions in high-frequency, high-voltage, and fiber-optic technology for mobile communication networks, data centers, test & measurement applications, automotive electronics, as well as high-voltage contact systems, medical electronics or aerospace engineering.

A global network of R&D, manufacturing and assembly locations provides innovation, optimized cost structure and excellent customer services world-wide.

## Contacts Automotive

### Headquarters

#### **Rosenberger**

Rosenberger Hochfrequenztechnik GmbH & Co. KG  
Hauptstraße 1 | 83413 Fridolfing  
P.O. Box 1260 | 84526 Tittmoning  
Germany  
Phone +49 8684 18-0  
info@rosenberger.com  
www.rosenberger.com

### Sales Automotive

#### **Europe**

##### **Germany**

Rosenberger Hochfrequenztechnik  
GmbH & Co. KG  
Hauptstraße 1  
83413 Fridolfing  
Germany  
Phone + 49 8684 18 1694  
automotive@rosenberger.com

##### **France**

Rosenberger Automotive France  
43 Rue de Belfort  
25200 Montbéliard  
France  
Phone + 33 9 87 71 67 67  
Mobile + 33 7 87 50 51 59  
automotive.france@rosenberger.com

##### **Italy**

Rosenberger Italia Srl  
Via Torri Bianche 7 - Piano 7  
20871 Vimercate (MI)  
Italy  
Phone + 39 039 96 30306  
info-italia@rosenberger.com

##### **Spain**

Rosenberger Telecom, S.A.  
C/Lozoya nº2, nave 18 -  
P.I. Ventorro del Cano  
28925 Alcorcón - Madrid  
Spain  
Phone + 34 91 352 8352  
Fax + 34 91 352 9813  
rosenberger@rosenberger.es

##### **Sweden**

Rosenberger Sverige AB  
Fågelsångsvägen 7B  
18642 Vallentuna  
Sweden  
Phone + 46 8 636 2600  
info@rosenberger.se

##### **United Kingdom**

Rosenberger UK Ltd.  
York House, Cottingley Business Park  
Bradford, BD16 1PE  
England  
United Kingdom  
Phone + 44 7980 730423  
automotive.uk@rosenberger.com

#### **North America**

##### **USA**

Rosenberger Automotive USA  
Fairlane Office Center  
4 Parklane Boulevard, Suite 307  
Dearborn, MI 48126  
United States of America  
Phone + 1 734 673 4131  
Phone + 1 248 259 5750  
automotive.usa@rosenberger.com

##### **USA - Non-Automotive Applications**

Rosenberger North America  
PO Box 309, 309 Colonial Drive  
Akron, PA 17501  
United States of America  
Phone + 1 717 859 8900  
info@rosenbergerna.com





The Rosenberger headquarters, located in Fridolfing in the southeast part of Bavaria, Germany, is the global center for our activities.

## South America

### Brazil

Rosenberger Domex Telecom Ltda.  
 Cabletech Avenue, 601  
 Guamirim  
 CEP 12295-230  
 BR-Cacapava - São Paulo  
 Brazil  
 Phone + 55 12 3221 8500  
 Fax + 55 12 3221 8543  
 vendas@rosenbergerdomex.com.br

### Chile

Rosenberger Sudamérica Ltda.  
 Aldunate 1961,  
 Santiago 836-1195  
 Chile  
 Phone + 56 2 3 67 11 70  
 Fax + 56 2 3 67 12 78  
 rosenberger@rosenberger.cl

## Asia

### China, Asia, Australia

Rosenberger  
 Asia Pacific Electronic Co., Ltd.  
 No. 3, Anxiang Road, Block B  
 Tianzhu Airport Industrial Zone  
 Beijing 101300  
 PR China  
 Phone + 86 10 80 48 19 95  
 Fax + 86 10 80 48 24 38  
 info@rosenberger.com.cn

### Japan

Rosenberger Automotive Japan, LLC.  
 KITOKI 3F, 8-5 Nihonbashikabuto-cho,  
 Chuo-ku  
 103-0026 Tokyo  
 Japan  
 Phone + 81 3 5860 9440  
 automotive.japan@rosenberger.com

## Korea

Rosenberger Automotive Korea  
 #1104, ACE Gwanggyo Tower 3  
 77, Changnyong-daero 256beon-gil,  
 Yeongtong-gu, Suwon-si, Gyeonggi-do,  
 16229  
 Republic of Korea  
 Phone + 82 70 7779 2236  
 Mobile + 82 10 4729 6194  
 automotive.korea@rosenberger.com

## India

Rosenberger Interconnect India Private  
 Limited  
 Plot No. 263, Sector 6  
 IMT Manesar, Gurugram  
 Haryana-122050  
 India  
 Phone +91 832 6686600  
 contact-rin@rosenberger.com

# Quality & Environment

The quality of our products, solutions and services is an essential part of our corporate strategy.

Ensuring the optimum quality of products and services and taking responsibility for our environment are fundamental elements of Rosenberger's corporate philosophy. Our quality philosophy does not just cover the optimization of parts and products, but also the continuous improvement of all company processes: from product development, planning, procurement, production, sales, logistics right through to environmental policy. To summarize, we want to offer maximum benefits for our customers all over the world.

We aim to act in an environmentally conscious manner, use materials economically, protect natural resources, recycle, and ensure energy efficiency.

As we have continuously improved our processes and consistently applied our quality management systems, we have been awarded many certificates.

Rosenberger has won a number of prestigious quality awards and prizes from several renowned customers and organizations for implementing its quality and environmental objectives.

## IMDS System

Rosenberger is registered with the IMDS system (Internationales MaterialDatenSystem der Automobilindustrie) since 2001. The products are fed systematically into the IMDS system.

[www.mdsystem.com](http://www.mdsystem.com)





#### Certificates

- IATF 16949
- DIN EN 9100
- ISO 9001
- ISO 14001
- DaKKs accreditation according to DIN EN ISO 17025

# Competencies & Technology

Rosenberger's mission is to be a leader when it comes to innovation and technology within its business segments.

The ongoing focus on cost management and process optimization complements our commitment to the increasingly stringent requirements for delivering products of the highest quality. Effective research & development, the very latest manufacturing technologies, the highest possible levels of efficiency in production processes, and continuous improvement of process automation make up Rosenberger's core competencies.





## Research & Development

Science-based high frequency know-how enables us to continuously improve existing products and to design innovative products and solutions whether standard or customer specific. Numerous patents are proof of Rosenberger's leadership as a creative and innovative partner.

## Production

By manufacturing everything in house and using state of-the-art manufacturing technologies, Rosenberger can continue to develop and optimize key manufacturing technologies – turned parts production, stamped & formed technology, injection molding technology. Manufacturing everything in house ensures a high degree of flexibility, and continuous quality controls, and means that newly designed products can be produced in the required quantities.

## Surface Treating Technology

Our components can be electroplated quickly and flexibly in our own in-house electroplating facilities, regardless of whether this is to provide corrosion protection, optimized conductivity, or other technical and physical characteristics. Environmental protection is another key factor which must be taken into account when coating surfaces.

## Joining Technology

Rosenberger operates manufacturing and assembly locations around the world – fully automated assembly centers and customer-oriented cable assembly locations offer global support and local sourcing.

## Injection Molding

We use the very latest machinery and methods, as well as special materials and components to ensure the precision and durability of our tools and products. Rosenberger is able to process all available high-performance plastics.

## EMC and RF Design

The increasing amount of electrical systems in hybrid and/or self-driven-vehicles increases the probability that electrical currents will interact with one another. To reduce unwanted effects, such as a high bit error rate, good shielding is needed. In addition, in unshielded systems with differential transmission technology, EMC is even more important. Furthermore, even if your transmission line is unaffected by the environment, the loss of signal quality caused by reflections or cable attenuation has to be minimized.

To analyze the transmission behavior, FEM and circuit simulation tools are used. Different system parameters, such as characteristic impedance, transmission and reflection coefficient, crosstalk and screening attenuation can be determined and optimized by simulation.

As a result, high frequency signals with high signal-to-noise ratio and high transmission form the basis for implementing efficient modulation schemes for ever-increasing data rates.

## Mechanical and Thermal Design

Due to strict safety standards for hybrid/electrical engines and autonomous driving, the mechanical and thermal requirements have increased considerably in recent years.

Mechanical FEM calculations are performed for high retention forces or high coding efficiency at the connector plastic housing. Investigations into the physics of an electrical contact (e.g., electrical resistance or fretting) enable us to design contact springs with optimized contact forces and an electrically stable contact resistance over their entire lifetime, taking into account all tolerances, for example.

Knowledge about the resistance of a contact is the key when it comes to simulating power loss and heating of the contact system. This makes it possible to achieve mechanical robustness, high efficiency, and minimal heating of the connector even quicker.

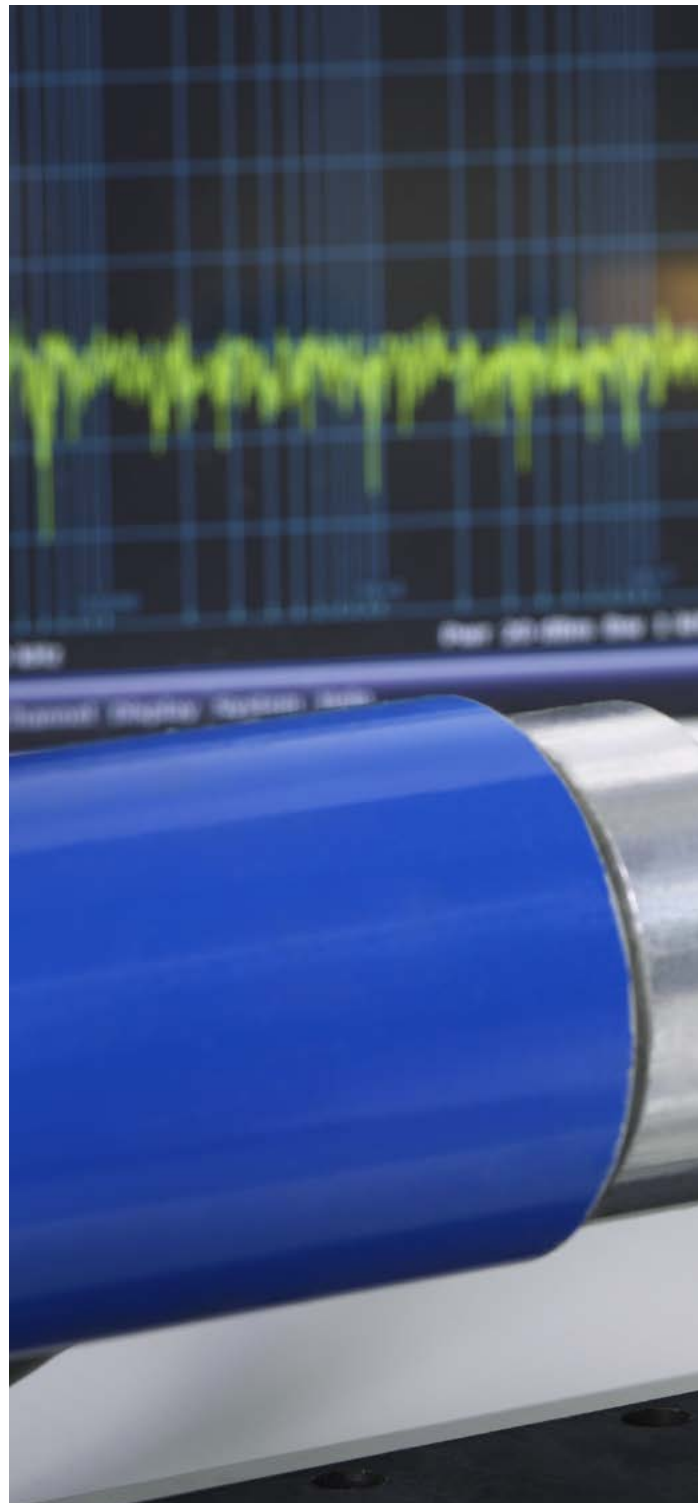

# Research & Development

One of the basic requirements of automotive contact systems is to create a robust electrical and mechanical design in a very small installation space. When it comes to achieving this, simulation-based component development is the state of the art.

Specialists from different engineering sciences support all departments during the complete product lifetime. Finite element (FEM) calculations are used to get the products on the market quickly and keep the development costs down, especially for early concepts.



# Rosenberger Automotive

At Rosenberger, we firmly believe in developing technology for the future. We are currently working on products and solutions that will shape our lives in the future.

We want to get faster and smarter in what we do and how we do it. Car driver assistance systems, connected car technology, electromobility, infotainment systems – Rosenberger is extremely committed to designing innovative connector systems for future automotive electronics.

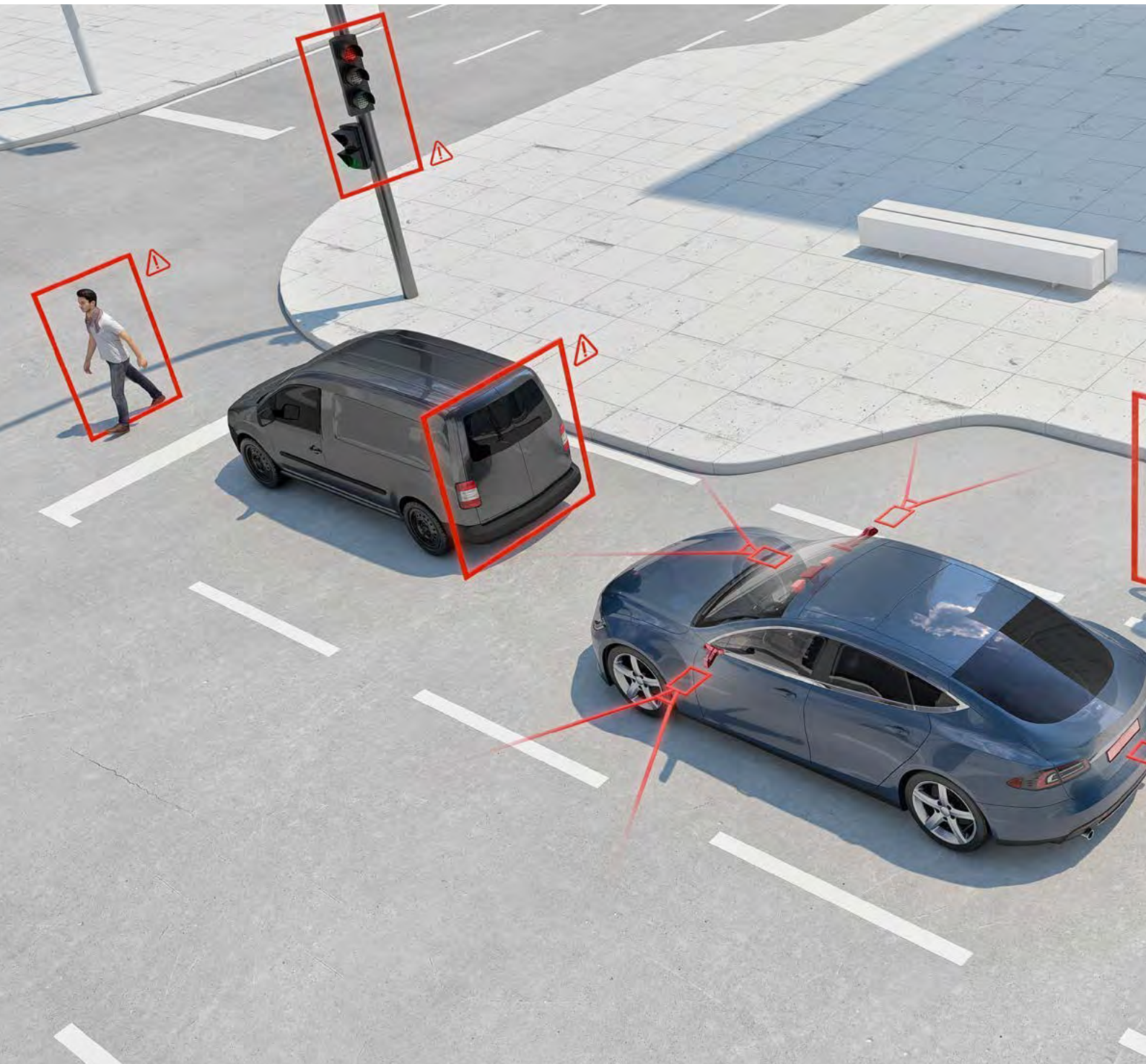

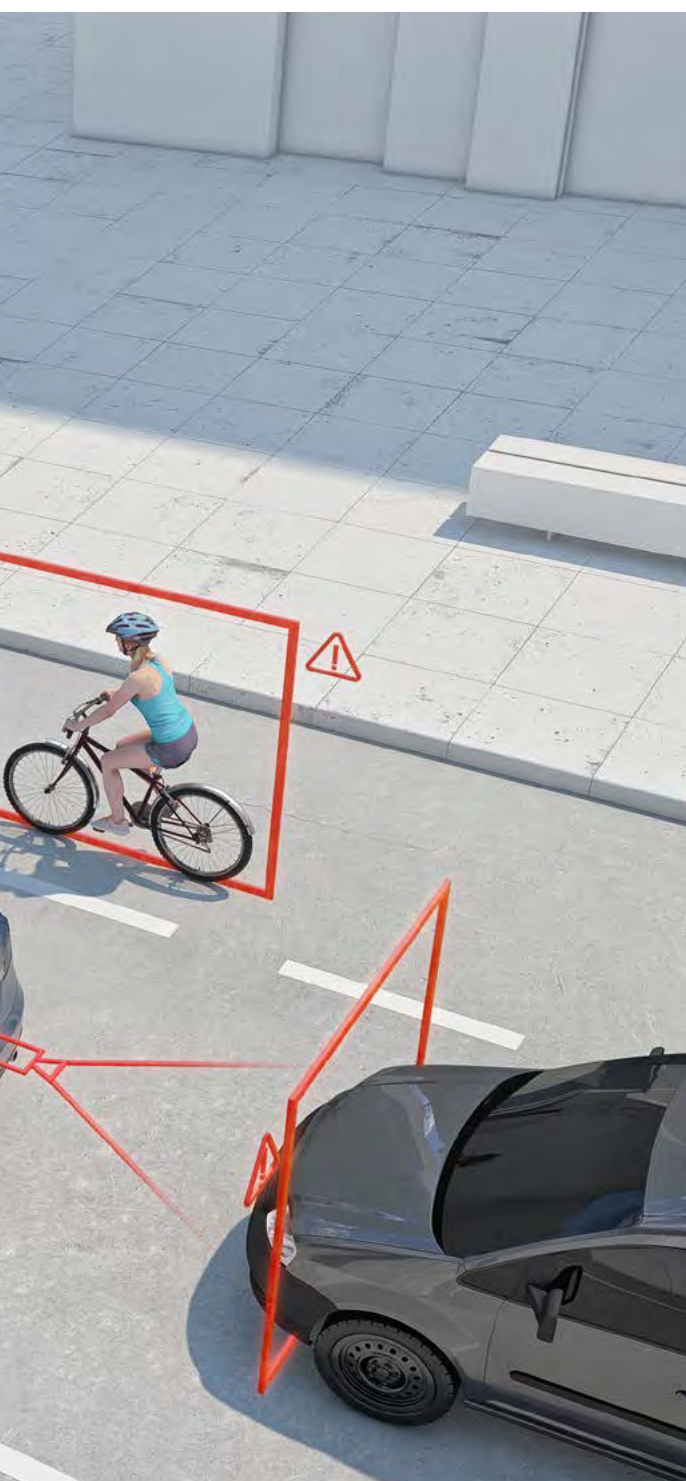

In 2000, Rosenberger started working in the automotive sector, designing and producing customized and standard products for these specific markets.

Rosenberger Automotive is a specialist development partner when it comes to integrating connector designs and customer-specific solutions with the highest quality and best performance – while continuing to meet customer price targets.

The contact systems have been specially designed to fulfill the tough requirements of the automotive industry. From the beginning, Rosenberger has developed a close and open relationship with its customers.

The priority in the most automotive applications, such as autonomous driving and driver assistance systems, is to ensure safety. It is necessary to determine exact positions, continuously calculate routes, and detect and classify objects. High data volumes from several cameras, various sensors, and navigation sources must be combined and transported for this purpose – in real time.

#### Application Areas

- Autonomous Driving
- Driver Assistance Systems
- Navigation
- Infotainment
- Fond-Entertainment
- Internet & Mobile Communication
- Next Generation WLAN: "WiGig" (Wireless Gigabit)

# RosenbergerHSD<sup>®</sup> Product Overview

Rosenberger has developed a homogeneous impedance-controlled interconnect system for High-Speed Data (RosenbergerHSD<sup>®</sup>) applications. This is a high-performance digital system for low-voltage differential signals which prevents interference from crosstalk and external sources. RosenbergerHSD<sup>®</sup> is a 100  $\Omega$  fully-shielded interconnect system that can use shielded twisted quad cables.

## Product Range

Cable and PCB connectors, cable assemblies, water-proof types:

- RosenbergerHSD<sup>®</sup>
- RosenbergerHSD<sup>®</sup>double 8 mm
- RosenbergerHSD<sup>®</sup>double 12.7 mm
- RosenbergerHSD<sup>®</sup>+2 types
- RosenbergerHSD<sup>®</sup>+4 types
- RosenbergerHSD<sup>®</sup>+8 types
- RosenbergerHSD<sup>®</sup>t types

## Mechanical Properties

- Primary and secondary lock
- Crimp connection
- Insertion funnel on jack inner conductors
- Plug pins protected by plastic domes
- High cable retention force
- High coding efficiency (different codings to eliminate misconnections are available on the plastic housing)
- No contact pin damage possible
- Scoop proof

## Applications

- Automotive electronics
- Telecom industries, e.g. radio base stations
- Digital infotainment electronics
- Digital symmetrical networks
- USB 1.0, 2.0, 3.0
- LVDS
- Ethernet
- IEEE 1394 (Firewire)
- APiX<sup>®</sup>
- CAN (Controller Area Network)
- MHL<sup>™</sup> (Mobile High-Definition Link)
- PCIe
- FPD-Link
- GMSL
- GVIF

## RosenbergerHSD<sup>®</sup> Connectors

The RosenbergerHSD<sup>®</sup> interconnect system is designed for the automotive market, e.g., LVDS camera, USB, and IEEE 1394 applications. The RosenbergerHSD<sup>®</sup> system features mechanical keying, latching, color code options, and a minimum size to satisfy global automotive requirements.



## RosenbergerHSD®+2, +4, +8 Connectors

RosenbergerHSD®+2, +4, +8 (on request) power pin connectors – further variants with additional pins (MQS contacts) for power supply purposes.



## RosenbergerHSD®t Connectors

RosenbergerHSD®t connectors using just one data pair, they are available in two versions to suit shielded as well as unshielded twisted pair cables.

Featuring the well-known piece parts of the standard RosenbergerHSD® system they are very costefficient high-speed data connectors. The RosenbergerHSD®t are used in Ethernet applications and fulfill the very high requirements of the automotive industry.



# RosenbergerHSD® Number Codes

D4	K	1	0	A –	1	xx	A5 –	y		
									Coding	Direction
									A Jet black / Graphite black	A Cable down, left, right
									B Cream white	B Cable down, left, right
									C Signal blue / Light blue	C Cable down, left, right
									D Claret violet	D Cable down, left, right
									E Leaf green / May green	E Cable down, left, right
									F Nut brown	F Cable down, left, right
									Z Water blue (neutral coding for cable down, left, right)	Z Cable down, left, right
									G Blue grey	G Cable up
									H Heather violet	H Cable up
									J Beige	J Cable up
									K Curry	K Cable up
									L Yellow green	L Cable up
									M Pastel orange	M Cable up
									O Light green (neutral coding for cable up)	O Cable up
									y Placeholder for required coding	y
									Plating	
									01-Z9 Cable group	
									00 Blank	
									0M Surface mount device	
									xx Blank cable group	
									1 Crimp	
									4 PCB mounting	
									Successive number	
									0 Standard cable down	
									U Cable up	
									L Cable left	
									R Cable right	
									1 Straight connector	
									2 Right Angle connector	
									K Female jack	
									S Male plug	
									W Tools	
									Z Plastic housings and accessories	
									Connector series	
									D4 RosenbergerHSD®	
									D2 RosenbergerHSD®t	
									99 Special products power pin (RosenbergerHSD®+2, +4, +8)	

## RosenbergerHSD® Cable Groups

Cable Group	Impedance	Cable Type
D5	100 Ω	e.g. G&G K6750, X6656, LEONI Dacar® 535, 535-2, 636, 636-2
AF	90 ± 15 Ω	e.g. G&G X6238, LEONI Dacar® 566
AU	100 Ω	e.g. G&G X9207

## RosenbergerHSD®t Cable Group

Cable Group	Impedance	Cable Type
D9	100 Ω	e.g. LEONI Dacar® 686-3
AQ	100 Ω	e.g. G&G 2Speed® 132, LEONI Dacar® 676

## RosenbergerHSD® Plating Code

## Outer Contact

Code	Plating	Symbol	Layer thickness	Magnetic properties
A	Nickel	Ni	3.00 µm	
L	AuroDur®	Au	0.15 µm	non magnetic

## Center Contact

Code	Plating	Symbol	Layer thickness	Magnetic properties
5	AuroDur®	Au	0.15 µm	non magnetic

The used platings of outer and center contacts of Rosenberger connectors can be identified by each part number.

Example:

D4S23L-40MA5-y

Plating outer contact: Nickel (A)

Plating center contact: AuroDur® (5)

## AuroDur® – The Rosenberger Standard Plating for Gold Surfaces

AuroDur® plating is the standard gold surface for all Rosenberger connector series.

AuroDur® has been developed by the engineering and metallurgical team at Rosenberger, well-experienced in developing electroplating standard and customized surfaces.

The AuroDur® surface consists of a thin gold layer on a non-magnetic, chemically deposited layer of nickel: min. 2 µm Ni, 0.15 µm Au

AuroDur® gold plating fully satisfies the high mechanical and electrical demands of radio frequency connectors. In contrast to conventional platings, essential characteristics are improved.

## Properties:

- High abrasion and corrosion resistance
- Excellent intermodulation
- Low contact resistance
- Very good solderability
- Optimal distribution of layer thickness
- RoHS conform

# RosenbergerHSD<sup>®</sup> Codings

Coding RosenbergerHSD<sup>®</sup>, HSD<sup>®t</sup> (Cable down, left, right)  
 HSD<sup>®+2</sup>, HSD<sup>®+4</sup> (Cable down, right)

Coding	Jack	Plug	Color / RAL-No. (similar)
A			Jet black / 9005
B			Cream white / 9001
C			Signal blue / 5005
D			Claret violet / 4004
E			Leaf green / 6002
F			Nut brown / 8011
Z (neutral coding, only for this table)			Water blue / 5021

Availability of the specific coding on request. Colors of the plastic housings are in accordance with the listed RAL colors, minor color differences due to manufacturing are possible.

## Definition Cable Exit down, left, right

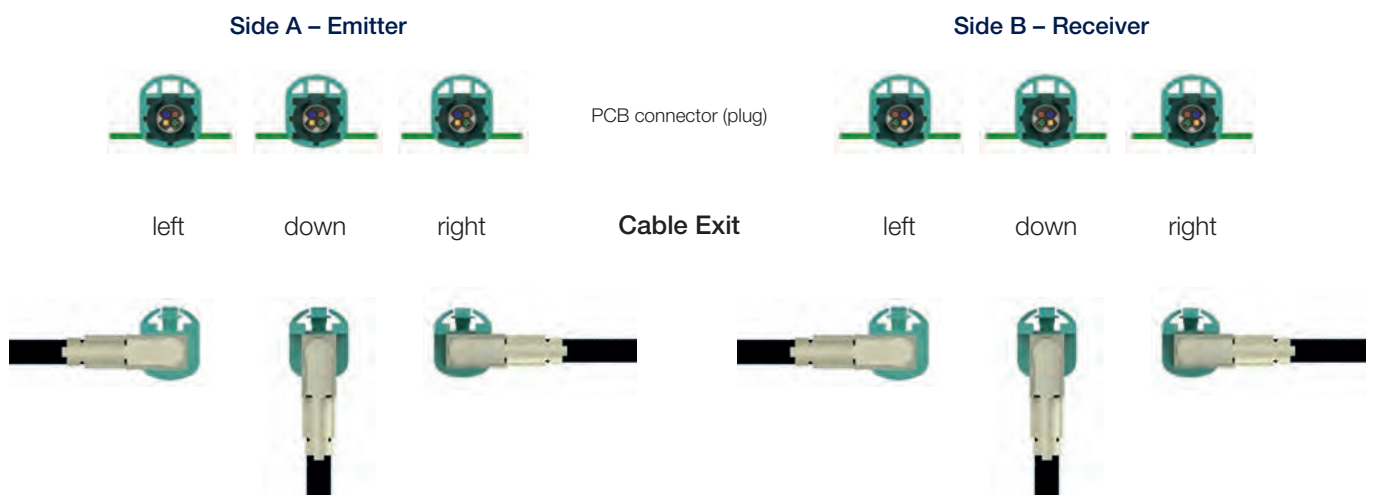

Coding RosenbergerHSD®, HSD®t (Cable up)  
 HSD®+2, HSD®+4 (Cable up, left)

Coding	Jack	Plug	Color / RAL-No. (similar)
G			Blue gray / 7031
H			Heather violet / 4003
J			Beige / 1001
K			Curry / 1027
L			Yellow green / 6018
M			Pastel orange / 2003
O (neutral coding, only for this table)			Light green / 6027

Availability of the specific coding on request. Colors of the plastic housings are in accordance with the listed RAL colors, minor color differences due to manufacturing are possible.

Definition Cable Exit up

Side A – Emitter

Side B – Receiver



up

Cable Exit

up



PCB connector (plug)



## Coding RosenbergerHSD® double 8 mm male

Coding	Jack	Plug	Color / RAL-No. (similar)
A			Jet black / 9005 
B			Cream white / 9001 
C			Signal blue / 5005 
D			Claret violet / 4004 
E			Leaf green / 6002 
F			Nut brown / 8011 
Z (neutral coding, only for this table)			Water blue / 5021 









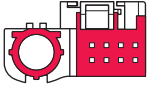
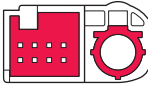

Availability of the specific coding on request. Colors of the plastic housings are in accordance with the listed RAL colors, minor color differences due to manufacturing are possible.

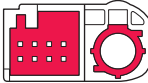
Coding RosenbergerHSD® double 12.7 mm male

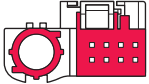
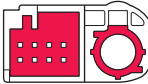
Coding	Jack	Plug	Color / RAL-No. (similar)
A (A+B)			Graphite black / 9011
B (B+A)			Cream white / 9001
C (C+D)			Light blue / 5012
D (D+C)			Claret violet / 4004
E (E+F)			May green / 6017
F (F+E)			Nut brown / 8011
Z (Z+Z) (neutral coding, only for this table)			Water blue / 5021

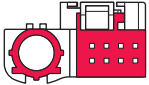
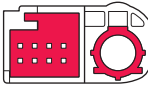
Availability of the specific coding on request. Colors of the plastic housings are in accordance with the listed RAL colors, minor color differences due to manufacturing are possible.

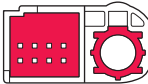
## Coding RosenbergerHSD®+8 male

Coding	Jack	Plug	Color / RAL-No. (similar)
A			Graphite black / 9011 
B			Cream white/natural / 9001 
C			Light blue / 5012 
D			Claret violet / 4004 
Z (neutral coding, only for this table)			Water blue / 5021 

Availability of the specific coding on request. Colors of the plastic housings are in accordance with the listed RAL colors, minor color differences due to manufacturing are possible.

Interface Dimensions RosenbergerHSD®

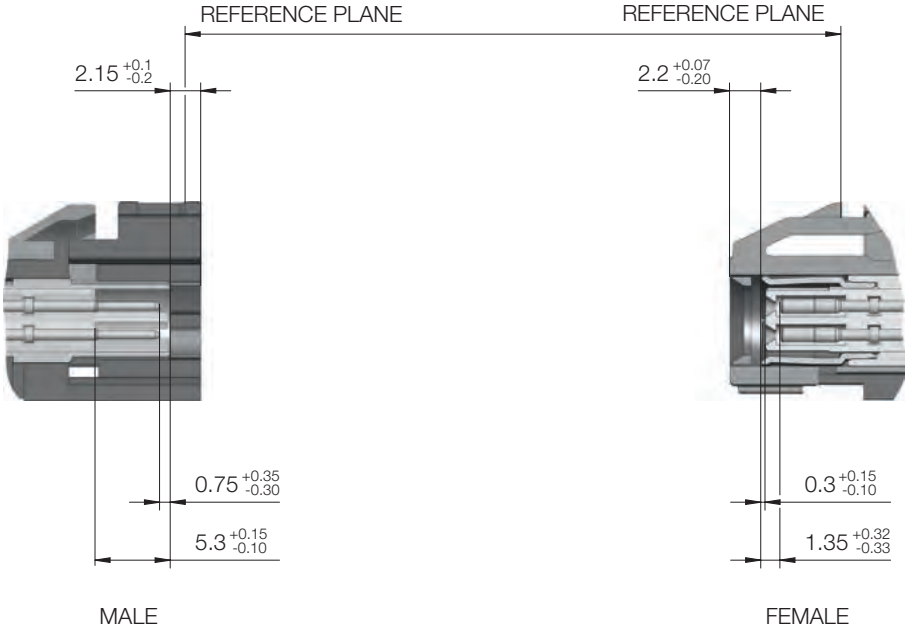

Pinning RosenbergerHSD®

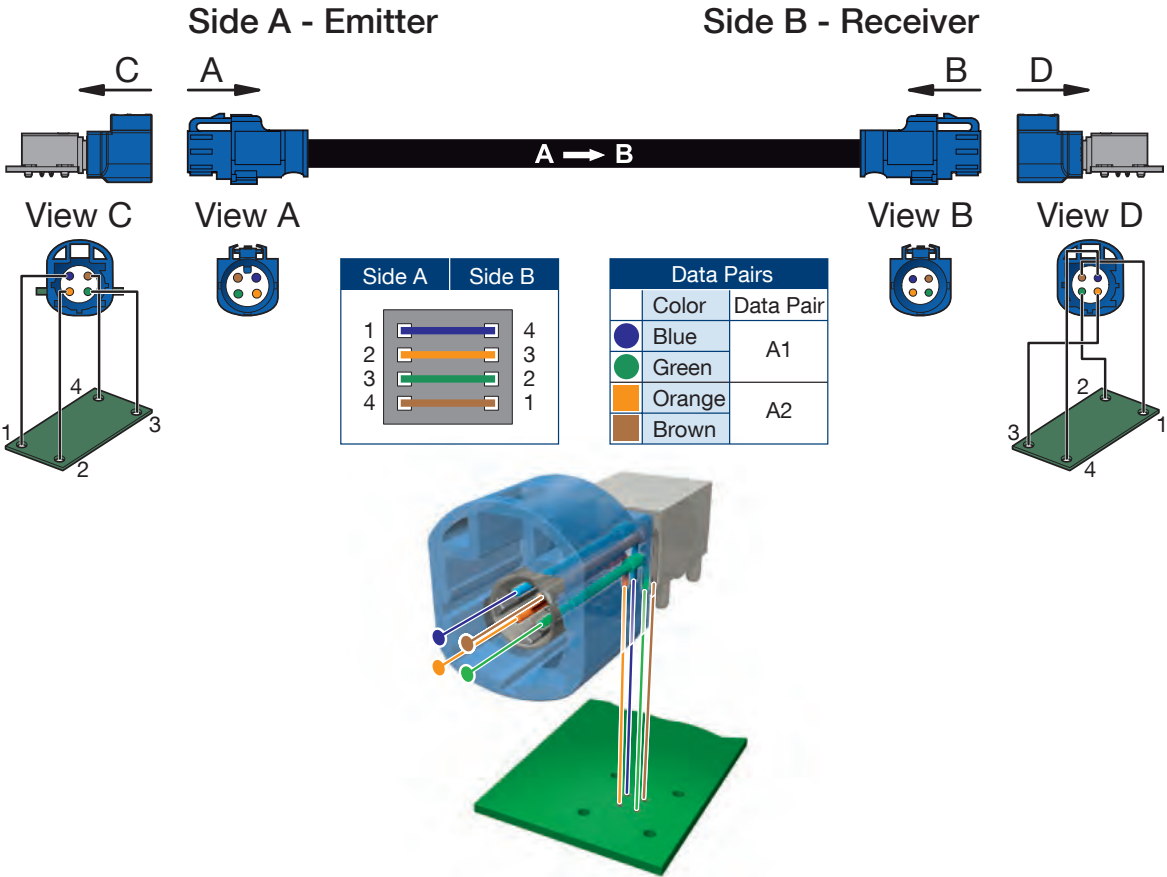

Pinning according Rosenberger norm RN\_053-01

# RosenbergerHSD® Technical Data

## Technical Data RosenbergerHSD® (Code D4)

### Applicable Standards

Interface according to	RosenbergerHSD®: RN_059-01 RosenbergerHSD®waterproof: RN-063_01 RosenbergerHSD®double 8 mm: RN_059-02 RosenbergerHSD®double 12.7 mm: RN_059-03 RosenbergerHSD®+2: RN_066-01 RosenbergerHSD®+4: RN_066-03 RosenbergerHSD®+8: RN_066-02
Quality tested according to	Rosenberger Norm: RN_061-01

### Electrical Data

Impedance	100 Ω
Frequency range depending on cable type	DC to 6 GHz
Return loss	≥ 20 dB, DC to 1 GHz ≥ 17 dB, 1 GHz to 2 GHz
Insertion loss	≤ 0.1 dB, DC to 2 GHz
Skew (between signal contacts) Straight connectors Right angle connectors	≤ 5 ps ≤ 25 ps
Near end crosstalk	≤ - 30 dB, DC to 1 GHz
Far end crosstalk	≤ - 35 dB, DC to 1 GHz
Insulation resistance	≥ 1 x 10 <sup>3</sup> MΩ
Signal contact resistance	≤ 10 mΩ
Outer contact resistance	≤ 7.5 mΩ
Test voltage	250 V rms
Working voltage	60 V rms
Contact current depending on cable type	≤ 3 A DC @ 85 °C ambient temperature
Coupling attenuation	≥ 75 dB, DC to 1 GHz ≥ 65 dB, 1 GHz to 2 GHz

### Mechanical Data

Mating cycles (standard, non waterproof)	≥ 25
Mating cycles (waterproof)	≥ 5
Engagement force	≤ 30 N
Engagement force waterproof	≤ 40 N
Disengagement force	≥ 5 N
Retention force latch	≥ 110 N
Retention force primary lock	≥ 80 N
Retention force secondary lock	≥ 60 N
Polarization feature effectiveness	≥ 80 N

## Environmental Data

Temperature range	-40 °C to +105 °C
Thermal shock	IEC 60068-2-14
Vibration	IEC 60068-2-64
Mechanical shock	IEC 60068-2-27
Temperature and humidity	USCAR 2-4 5.6.2
Dry heat	IEC 60068-2-2
Max. soldering temperature	IEC 60068-2-58, group 3 & 4

## Materials

Outer contact	CuZn, CuSn (Brass, Bronze), or equivalent
Signal contacts	CuZn, CuSn (Brass, Bronze), or equivalent
Dielectric	PA, LCP, or equivalent
Gasket	Silicone, Rubber, or equivalent
Crimping ferrule	CuSn (Bronze), or equivalent
Plastic housings and secondary lock	PA, PBT, or equivalent

## Platings

Outer contact	AuroDur®, Nickel, Tin
Signal contacts	AuroDur®

Rosenberger connectors fulfill in principle the indicated data of the Technical Data. Individual values of connectors may deviate depending upon application, design, type of cable, assembly method and execution. Specific data sheets for particular products can be provided on request from your Rosenberger sales partner.





# RosenbergerHSD® Connectors

## PCB Connectors – Wave Soldering

### Straight Plug, Single

Rosenberger No.	Remarks	Panel Piercing / PCB Layout	Coding RosenbergerHSD®	Packing Unit	Product
D4S10A-400L5-y	Wave soldering 4 signal pins	MB 214	A, B, C, D, E, F, Z	125 tape & reel	

### Right Angle Plug, Single

Rosenberger No.	Remarks	Panel Piercing / PCB Layout	Coding RosenbergerHSD®	Packing Unit	Product
D4S20G-400A5-y	Wave soldering 4 signal pins	MB 261	A, B, C, D, E, F, Z	800 blister 175 tape & reel	
D4S2UG-400A5-y	Wave soldering 4 signal pins connector only mateable with jack, cable up	MB 261	<b>G, H, J, K, L, M, O</b>	800 blister 200 tape & reel	
D4S20Y-400A5-y	Wave soldering 4 signal pins spring basket feature for EMC shielding connector only	MB 322	A, B, C, D, E, F, Z	50 blister	
D4S2UY-400A5-y	Wave soldering 4 signal pins spring basket feature for EMC shielding connector only mateable with jack, cable up	MB 640	<b>G, H, J, K, L, M, O</b>	220 tape & reel	
D4S24D-400A5-y	Wave soldering 4 signal pins waterproof	MB 261, MB 770	A, B, C, D, E, F, Z	25 blister	



### Right Angle Plug, Double 12.7 mm

Rosenberger No.	Remarks	Panel Piercing / PCB Layout	Coding RosenbergerHSD® double 12.7 mm	Packing Unit	Product
D4S20P-400A5-y	Wave soldering 2 x 4 signal pins	MB 359	A, B, C, D, E, F, Z	30 blister	

y: Please fill-in required coding, availability of the specific coding on request

## PCB Connectors – Pin-in-Paste

## Straight Plug, Single

Rosenberger No.	Remarks	Panel Piercing / PCB Layout	Coding RosenbergerHSD®	Packing Unit	Product
D4S10E-40MA5-y	Pin-in-paste 4 signal pins	MB 759	A, B, C, D, E, F, Z	150 tape & reel	
D4S12H-40MA5-y	Pin-in-paste 4 signal pins	MB 285	A, B, C, D, E, F, Z	150 tape & reel	
D4S14D-40MA5-y	Pin-in-paste 4 signal pins waterproof	MB 285	A, B, C, D, E, F, Z	80 tape & reel	

## Right Angle Plug, Single

Rosenberger No.	Remarks	Panel Piercing / PCB Layout	Coding RosenbergerHSD®	Packing Unit	Product
D4S23L-40MA5-y	Pin-in-paste 4 signal pins frequency DC to 2 GHz	MB 656	A, B, C, D, E, F, Z	200 tape & reel	
D4S23M-40MA5-y	Pin-in-paste 4 signal pins frequency DC to 10 GHz	MB 680	A, B, C, D, E, F, Z	200 tape & reel	
D4S2UL-40MA5-y	Pin-in-paste 4 signal pins connector only mateable with jack, cable up	MB 215	<b>G, H, J, K, L, M, O</b>	200 tape & reel	
D4S20Y-40MA5-y	Pin-in-paste 4 signal pins spring basket feature for EMC shielding connector only	MB 322	A, B, C, D, E, F, Z	190 tape & reel	
D4S2UY-40MA5-y	Pin-in-paste 4 signal pins spring basket feature for EMC shielding connector only mateable with jack cable up	MB 322	<b>G, H, J, K, L, M, O</b>	220 tape & reel	
D4S2UQ-40MA5-y	Pin-in-paste 4 signal pins spring feature for EMC shielding connector only mateable with cable jack, cable up	MB 215	<b>G, H, J, K, L, M, O</b>	150 tape & reel	

y: Please fill-in required coding, availability of the specific coding on request

## PCB Connectors – Pin-in-Paste

### Straight Plug, Double 8 mm

Rosenberger No.	Remarks	Panel Piercing	Coding RosenbergerHSD® double 8 mm	Packing Unit	Product
D4S10P-40MA5-y	Pin-in-paste 2 x 4 signal pins on request	MB 500	A, B, C, D, E, F, Z	150 tape & reel	

### Right Angle Plug, Double 8 mm

Rosenberger No.	Remarks	Panel Piercing	Coding RosenbergerHSD® double 8 mm	Packing Unit	Product
D4S20W-40MA5-y	Pin-in-paste 2 x 4 signal pins	MB 427	A, B, C, D, E, F, Z	135 tape & reel	

y: Please fill-in required coding, availability of the specific coding on request

## PCB Connectors – Pin-in-Paste

### Straight Plug, Double 12.7 mm

Rosenberger No.	Remarks	Panel Piercing / PCB Layout	Coding RosenbergerHSD® double 12.7 mm	Packing Unit	Product
D4S10V-40MA5-y	Pin-in-paste 2 x 4 signal pins	MB 411	A, B, C, D, E, F, Z	200 tape & reel	



### Right Angle Plug, Double 12.7 mm

Rosenberger No.	Remarks	Panel Piercing / PCB Layout	Coding RosenbergerHSD® double 12.7 mm	Packing Unit	Product
D4S21J-40MA5-y	Pin-in-paste 2 x 4 signal pins	MB 353	A, B, C, D, E, F, Z	200 tape & reel	





y: Please fill-in required coding, availability of the specific coding on request

## Cable Connectors

### Straight Jack, Single

Rosenberger No.	Remarks	Cable	Assembly Instruction	Coding RosenbergerHSD®	Packing Unit	Product
D4K10A-1D5A5-y	4 signal pins	e.g. Dacar 535, Dacar 636 4-pole	D4 V007	A, B, C, D, E, F, Z	on request	
D4K1UA-1D5A5-y	4 signal pins	e.g. Dacar 535, Dacar 636 4-pole	D4 V007	<b>G, H, J, K, L, M, O</b>	on request	

### Right Angle Jack, Single

Rosenberger No.	Remarks	Cable	Assembly Instruction	Coding RosenbergerHSD®	Packing Unit	Product
D4K20E-1D5A5-y	4 signal pins cable down	e.g. Dacar 535, Dacar 636 4-pole	D4 V037	A, B, C, D, E, F, Z	on request	
D4K2LE-1D5A5-y	4 signal pins cable left	e.g. Dacar 535, Dacar 636 4-pole	D4 V037	A, B, C, D, E, F, Z	on request	
D4K2RE-1D5A5-y	4 signal pins cable right	e.g. Dacar 535, Dacar 636 4-pole	D4 V037	A, B, C, D, E, F, Z	on request	
D4K2UE-1D5A5-y	4 signal pins cable up	e.g. Dacar 535, Dacar 636 4-pole	D4 V037	<b>G, H, J, K, L, M, O</b>	on request	

### Straight Plug, Single

Rosenberger No.	Remarks	Cable	Assembly Instruction	Coding RosenbergerHSD®	Packing Unit	Product
D4S10A-1D5A5-y	4 signal pins	e.g. Dacar 535, Dacar 636 4-pole	D4 V008	A, B, C, D, E, F, Z	on request	

y: Please fill-in required coding, availability of the specific coding on request

## Straight Jack, Double 8 mm

Rosenberger No.	Remarks	Cable	Assembly Instruction	Coding RosenbergerHSD® double 8 mm	Packing Unit	Product
D4K10C-1D5A5-y	2 x 4 signal pins on request	e.g. Dacar 535, Dacar 636 4-pole	on request	A, B, C, D, E, F, Z	on request	

## Right Angle Jack, Double 8 mm

Rosenberger No.	Remarks	Cable	Assembly Instruction	Coding RosenbergerHSD® double 8 mm	Packing Unit	Product
D4K20C-1D5A5-y	2 x 4 signal pins on request	e.g. Dacar 535, Dacar 636 4-pole	D4 V028	A, B, C, D, E, F, Z	on request	

## Straight Jack, Double 12.7 mm

Rosenberger No.	Remarks	Cable	Assembly Instruction	Coding RosenbergerHSD® double 12.7 mm	Packing Unit	Product
D4K10D-1D5A5-y	2 x 4 signal pins	e.g. Dacar 535, Dacar 636 4-pole	on request	A, B, C, D, E, F, Z	on request	

## Right Angle Jack, Double 12.7 mm

Rosenberger No.	Remarks	Cable	Assembly Instruction	Coding RosenbergerHSD® double 12.7 mm	Packing Unit	Product
D4K20B-1D5A5-y	2 x 4 signal pins	e.g. Dacar 535, Dacar 636 4-pole	D4 V037	A, B, C, D, E, F, Z	on request	

y: Please fill-in required coding, availability of the specific coding on request

# RosenbergerHSD® Connectors Waterproof

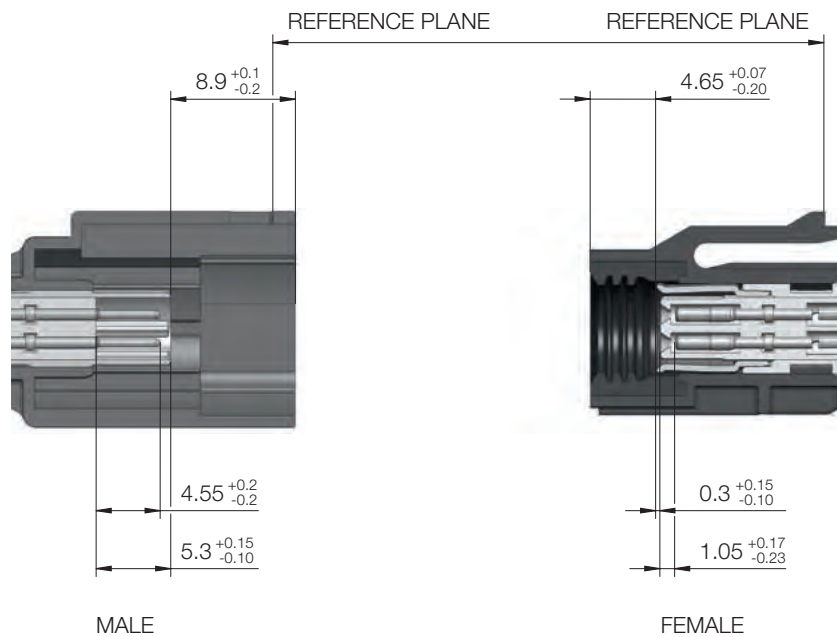

Mated waterproof RosenbergerHSD® connectors are suitable for outdoor use in the most demanding environments. The connectors are classified and tested according to DIN40050 IPX9K. Limited mating cycles up to 5.

## Interface Dimensions RosenbergerHSD® Waterproof





## PCB Connectors – Waterproof

### PCB Connectors, Single, Waterproof



Rosenberger No.	Remarks	Panel Piercing / PCB Layout	Coding RosenbergerHSD®	Packing Unit	Product
D4S14D-40MA5-y	Waterproof pin-in-paste 4 signal pins	MB 285	A, B, C, D, E, F, Z	80 tape & reel	
D4S24D-400A5-y	Waterproof wave soldering 4 signal pins	MB 261, MB 770	A, B, C, D, E, F, Z	25 blister	

## Cable Connectors – Waterproof

### Straight Jack, Single, Waterproof

Rosenberger No.	Remarks	Cable	Assembly Instruction	Coding RosenbergerHSD®	Packing Unit	Product
D4K14A-1D5A5-y	Waterproof 4 signal pins	e.g. Dacar 535, Dacar 636 4-pole	D4 V020	A, B, C, D, E, F, Z	on request	
D4K14C-1D5A5-y	Waterproof 4 signal pins short version	e.g. Dacar 535, Dacar 636 4-pole	D4 V036	A, B, C, D, E, F, Z	on request	

### Right Angle Jack, Single, Waterproof

Rosenberger No.	Remarks	Cable	Assembly Instruction	Coding RosenbergerHSD®	Packing Unit	Product
D4K25A-1D5A5-y	Waterproof 4 signal pins cable down	e.g. Dacar 535, Dacar 636 4-pole	D4 V038	A, B, C, D, E, F, Z	on request	
D4K25L-1D5A5-y	Waterproof 4 signal pins cable left	e.g. Dacar 535, Dacar 636 4-pole	D4 V038	A, B, C, D, E, F, Z	on request	
D4K25R-1D5A5-y	Waterproof 4 signal pins cable right	e.g. Dacar 535, Dacar 636 4-pole	D4 V038	A, B, C, D, E, F, Z	on request	

### Straight Plug, Single, Waterproof

Rosenberger No.	Remarks	Cable	Assembly Instruction	Coding RosenbergerHSD®	Packing Unit	Product
D4S14A-1D5A5-y	Waterproof 4 signal pins	e.g. Dacar 535, Dacar 636 4-pole	D4 V021	A, B, C, D, E, F, Z	on request	

y: Please fill-in required coding, availability of the specific coding on request

# RosenbergerHSD<sup>®</sup>+2 Power Pin Connectors

RosenbergerHSD<sup>®</sup>+2, +4, +8 (on request) power pin connectors – further variants with additional pins (MQS contacts) for power supply purposes.

## PCB Connectors – Pin-in-Paste

### Straight Plug, Single

Rosenberger No.	Remarks	Panel Piercing / PCB Layout	Coding RosenbergerHSD <sup>®</sup> +2	Packing Unit	Product
99S10R-40MA5-y	Pin-in-paste 4 signal pins 2 power pins	MB 728	A, B, C, D, E, F, Z	125 tape & reel	

### Right Angle Plug, Single

Rosenberger No.	Remarks	Panel Piercing / PCB Layout	Coding RosenbergerHSD <sup>®</sup> +2	Packing Unit	Product
99S23F-40MA5-y	Pin-in-paste 4 signal pins 2 power pins	MB 664	A, B, C, D, E, F, Z	170 tape & reel	

y: Please fill-in required coding, availability of the specific coding on request

## Cable Connectors

### Straight Jack, Single

Rosenberger No.	Remarks	Cable	Assembly Instruction	Coding RosenbergerHSD <sup>®</sup> +2	Packing Unit	Product
99K11D-1D5A5-y	4 signal pins 2 power pins	e.g. Dacar 535, Dacar 636 4-pole	D4 V030	A, B, C, D, E, F, Z	on request	

### Right Angle Jack, Single

Rosenberger No.	Remarks	Cable	Assembly Instruction	Coding RosenbergerHSD <sup>®</sup> +2	Packing Unit	Product
99K20K-1D5A5-y	4 signal pins 2 power pins cable down	e.g. Dacar 535, Dacar 636 4-pole	D4 V037	A, B, C, D, E, F, Z	on request	
99K2LK-1D5A5-y	4 signal pins 2 power pins cable left	e.g. Dacar 535, Dacar 636 4-pole	D4 V037	A, B, C, D, E, F, Z	on request	
99K2RK-1D5A5-y	4 signal pins 2 power pins cable right	e.g. Dacar 535, Dacar 636 4-pole	D4 V037	A, B, C, D, E, F, Z	on request	
99K2UK-1D5A5-y	4 signal pins 2 power pins cable up	e.g. Dacar 535, Dacar 636 4-pole	D4 V037	<b>G, H, J, K, L, M, O</b>	on request	

### Straight Plug, Single

Rosenberger No.	Remarks	Cable	Assembly Instruction	Coding RosenbergerHSD <sup>®</sup> +2	Packing Unit	Product
99S16D-1D5A5-y	4 signal pins 2 power pins with slot positioning clip	e.g. Dacar 535, Dacar 636 4-pole	D4 V008	A, B, C, D, E, F, Z	on request	

y: Please fill-in required coding, availability of the specific coding on request

# RosenbergerHSD<sup>®</sup>+4 Power Pin Connectors

## PCB Connectors – Pin-in-Paste

### Straight Plug, Single

Rosenberger No.	Remarks	Panel Piercing / PCB Layout	Coding RosenbergerHSD <sup>®</sup> +4	Packing Unit	Product
99S10L-40MA5-y	Pin-in-paste 4 signal pins 4 power pins	MB 518, MB 698	A, B, C, D, E, F, Z	150 tape & reel	

### Right Angle Plug, Single

Rosenberger No.	Remarks	Panel Piercing / PCB Layout	Coding RosenbergerHSD <sup>®</sup> +4	Packing Unit	Product
99S21L-40MA5-y	Pin-in-paste 4 signal pins 4 power pins	MB 619	A, B, C, D, E, F, Z	160 tape & reel	

## Cable Connectors

### Right Angle Jack, Single

Rosenberger No.	Remarks	Cable	Assembly Instruction	Coding RosenbergerHSD <sup>®</sup> +4	Packing Unit	Product
99K2LL-1D5A5-y	4 signal pins 4 power pins	e.g. Dacar 535, Dacar 636 4-pole	on request	A, B, C, D, E, F, Z	on request	

y: Please fill-in required coding, availability of the specific coding on request

# RosenbergerHSD®+8 Power Pin Connectors

## PCB Connectors – Pin-in-Paste

### Right Angle Plug, Single

Rosenberger No.	Remarks	Panel Piercing / PCB Layout	Coding RosenbergerHSD®+8	Packing Unit	Product
99S219-40MA5-y	Pin-in-paste 4 signal pins 8 power pins cable down	MB 651	A, B, C, D, E, F, Z	200 tape & reel	

## Cable Connectors

### Straight Jack, Single

Rosenberger No.	Remarks	Cable	Assembly Instruction	Coding RosenbergerHSD®+8	Packing Unit	Product
99K15A-1D5A5-y	4 signal pins 8 power pins on request	e.g. Dacar 535, Dacar 636 4-pole	99 V010	A, B, C, D, E, F, Z	on request	
99K15B-1D5A5-y	4 signal pins 8 power pins on request	e.g. Dacar 535, Dacar 636 4-pole	99 V010	A, B, C, D, E, F, Z	on request	

### Straight Plug, Single

Rosenberger No.	Remarks	Cable	Assembly Instruction	Coding RosenbergerHSD®+8	Packing Unit	Product
99S15A-1D5A5-y	4 signal pins 8 power pins on request	e.g. Dacar 535, Dacar 636 4-pole	D4 V033	A, B, C, D, E, F, Z	on request	

y: Please fill-in required coding, availability of the specific coding on request

# RosenbergerHSD<sup>®t</sup> Technical Data

## Technical Data RosenbergerHSD<sup>®t</sup> (Code D2)

### Applicable Standards

Interface according to	RosenbergerHSD <sup>®t</sup> : RN_119-01 RosenbergerHSD <sup>®t</sup> waterproof: RN_119-04
Quality tested according to	Rosenberger Norm: RN_061-01

### Electrical Data

Impedance	100 Ω
Frequency range depending on cable type	DC to 1 GHz
Return loss	$\geq \begin{cases} 38 & 1 \leq f < 75 \\ 20 - 20 \log\left(\frac{f}{600}\right) & 75 \leq f \leq 600 \end{cases} dB^*$
Insertion loss	$\leq (0.01\sqrt{f}) dB^*$
Mode conversion loss	$\geq \begin{cases} 55 & 10 \leq f \leq 80 \\ 77 - 11.51 \log(f) & 80 < f \leq 600 \end{cases} dB^*$
Skew (between signal contacts) Straight connectors Right angle connectors	$\leq 5$ ps $\leq 25$ ps
Near end crosstalk	$\leq -30$ dB, DC to 100 MHz
Far end crosstalk	$\leq -35$ dB, DC to 100 MHz
Insulation resistance	$\geq 1 \times 10^3$ MΩ
Signal contact resistance	$\leq 10$ mΩ
Test voltage	250 V rms
Working voltage	60 V rms
Contact current depending on cable type	$\leq 3$ A DC @ 85 °C ambient temperature

\* f in MHz

### Mechanical Data

Mating cycles (standard, non waterproof)	$\geq 25$
Mating cycles (waterproof)	$\geq 5$
Engagement force	$\leq 30$ N
Engagement force waterproof	$\leq 40$ N
Disengagement force	$\geq 5$ N
Retention force latch	$\geq 110$ N
Retention force primary lock	$\geq 80$ N
Retention force secondary lock	$\geq 60$ N
Polarization feature effectiveness	$\geq 80$ N
Cable torsion depending on cable type	$\geq 20$ Ncm

## Environmental Data

Temperature range	-40 °C to +105 °C
Thermal shock	IEC 60068-2-14
Vibration	IEC 60068-2-64
Mechanical shock	IEC 60068-2-27
Temperature and humidity	USCAR 2-4 5.6.2
Dry heat	IEC 60068-2-2
Max. soldering temperature	IEC 60068-2-58, group 3 & 4

## Materials

Signal contacts	CuZn, CuSn (Brass, Bronze), or equivalent
Dielectric	PA, LCP, or equivalent
Gasket	Silicone, Rubber, or equivalent
Crimping ferrule	CuSn (Bronze), or equivalent
Plastic housings and secondary lock	PA, PBT, or equivalent

## Platings

Signal contacts	AuroDur®
-----------------	----------

Rosenberger connectors fulfill in principle the indicated data of the Technical Data. Individual values of connectors may deviate depending upon application, design, type of cable, assembly method and execution. Specific data sheets for particular products can be provided on request from your Rosenberger sales partner.

# RosenbergerHSD<sup>®t</sup> Connectors

RosenbergerHSD<sup>®t</sup> connectors are mechanically based on standard Rosenberger<sup>®</sup>HSD design, but they are using just one data pair. Featuring the well-known piece parts of the standard RosenbergerHSD<sup>®</sup> system they are very cost-efficient high-speed data connectors. The RosenbergerHSD<sup>®t</sup> are used in Ethernet applications.

## Interface Dimensions RosenbergerHSD<sup>®t</sup>

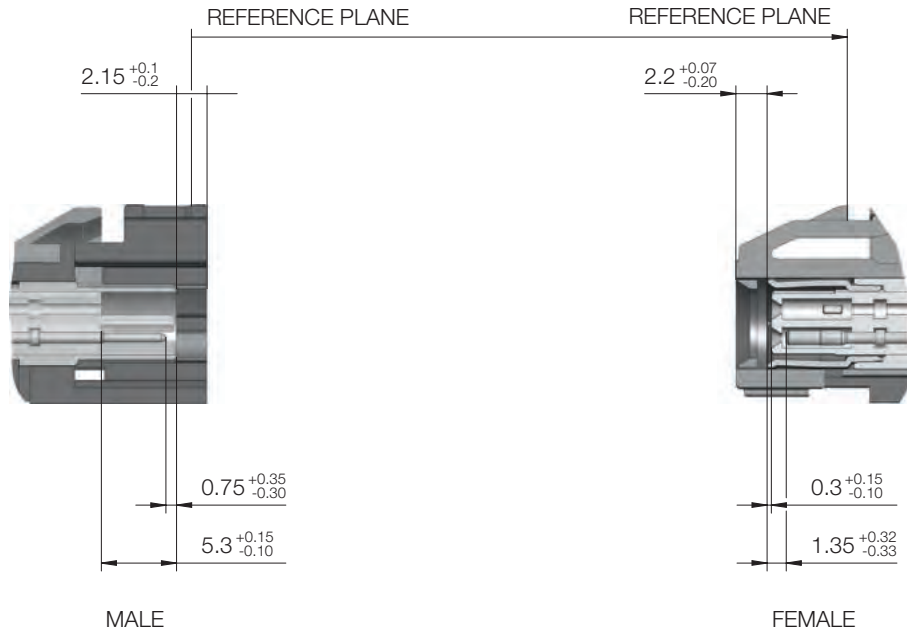

## Pinning RosenbergerHSD<sup>®t</sup>

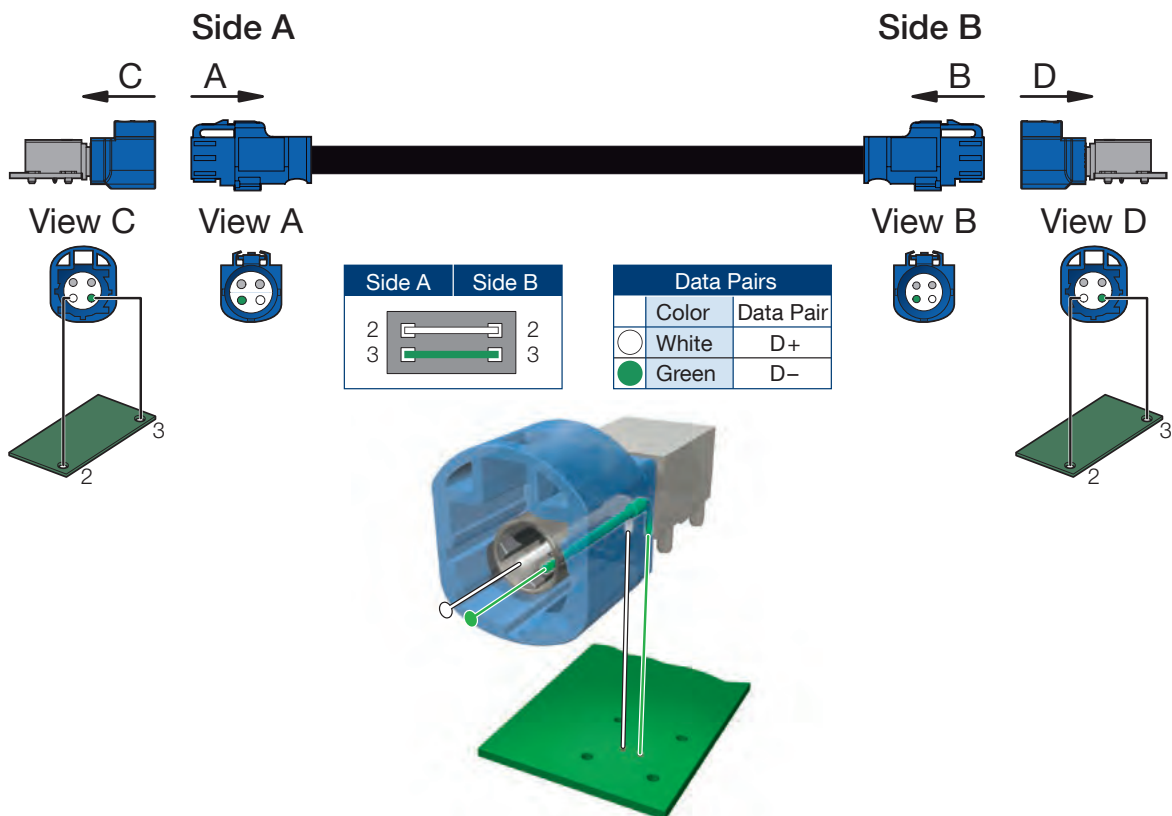

Pinning according to Rosenberger norm RN\_119-11

## Cable Connectors

### Straight Jack, Single

Rosenberger No.	Remarks	Cable	Assembly Instruction	Coding RosenbergerHSD®t	Packing Unit	Product
D2K10A-1D9A5-y	2 signal pins	LEONI Dacar 686-3	D2 V001	A, B, C, D, E, F, Z	on request	
D2K10A-1AQA5-y	2 signal pins	G&G 2Speed® 132	D2 V003	A, B, C, D, E, F, Z	on request	

### Right Angle Jack, Single

Rosenberger No.	Remarks	Cable	Assembly Instruction	Coding RosenbergerHSD®t	Packing Unit	Product
D2K20A-1D9A5-y	2 signal pins cable down	LEONI Dacar 686-3	D2 V007	A, B, C, D, E, F, Z	on request	

### Straight Plug, Single

Rosenberger No.	Remarks	Cable	Assembly Instruction	Coding RosenbergerHSD®t	Packing Unit	Product
D2S10A-1D9A5-y	2 signal pins	LEONI Dacar 686-3	D2 V002	A, B, C, D, E, F, Z	on request	
D2S10A-1AQA5-y	2 signal pins	G&G 2Speed® 132	D2 V004	A, B, C, D, E, F, Z	on request	

y: Please fill-in required coding, availability of the specific coding on request

# RosenbergerHSD<sup>®</sup>t Connectors Waterproof

Mated waterproof RosenbergerHSD<sup>®</sup>t connectors are suitable for outdoor use in the most demanding environments. The connectors are classified and tested according to DIN40050 IPX9K. Limited mating cycles up to 5.

## Interface Dimensions RosenbergerHSD<sup>®</sup>t Waterproof

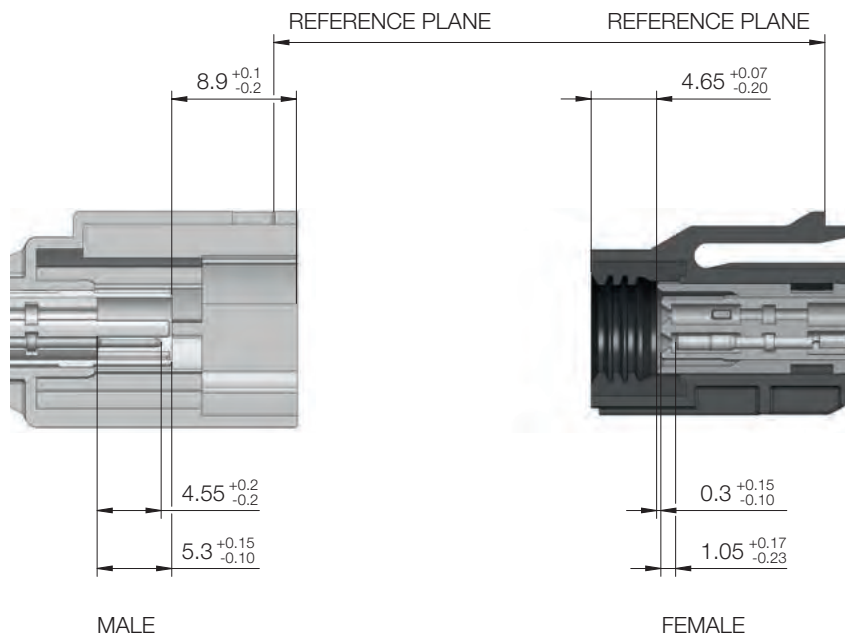

## Waterproof Connectors

### Straight Jack, Single, Waterproof

Rosenberger No.	Remarks	Cable	Assembly Instruction	Coding RosenbergerHSD®t	Packing Unit	Product
D2K14A-1D9A5-y	Waterproof 2 signal pins	LEONI Dacar 686-3	D2 V005	A, B, C, D, E, F, Z	on request	

### Right Angle Jack, Single, Waterproof

Rosenberger No.	Remarks	Cable	Assembly Instruction	Coding RosenbergerHSD®t	Packing Unit	Product
D2K25A-1D9A5-y	Waterproof 2 signal pins cable down	LEONI Dacar 686-3	D2 V011	A, B, C, D, E, F, Z	on request	

### Straight Plug, Single, Waterproof

Rosenberger No.	Remarks	Cable	Assembly Instruction	Coding RosenbergerHSD®t	Packing Unit	Product
D2S14A-1D9A5-y	Waterproof 2 signal pins	LEONI Dacar 686-3	D2 V006	A, B, C, D, E, F, Z	on request	

y: Please fill-in required coding, availability of the specific coding on request

# Test Components & Tools

## Adaptor – Equalizer RosenbergerHSD®

Rosenberger No.	Remarks	Coding RosenbergerHSD®	Packing Unit	Product
D4S1EQ-S01A5-yy	RosenbergerHSD® male – male Impedance 100 Ω Frequency range DC to 1 GHz Return loss ≥ 15 dB, DC to 500 MHz ≥ 10 dB, 500 MHz to 1 GHz Insertion loss ≤ 8.5 dB typ. @ DC ≤ 4.0 dB typ. @ 100 MHz ≤ 1.3 dB typ. @ 250 MHz ≤ 0.6 dB typ. @ 500 MHz ≤ 1.0 dB typ. @ 1.0 GHz Skew ≤ 40 ps Test voltage 50 V rms Working voltage 50 V rms Power current ≤ 0.3 A DC RF-leakage ≥ 65 dB, DC to 1 GHz (IEC 62153-4-7) ≥ 60 dB, 1 GHz to 2 GHz Improvement to Loss budget ≥ 12 dB @ 1.0 GHz Mating cycles ≤ 25	ZA, AF, BF, CF, DF, EF	1	

yy: Please fill-in required coding, availability of the specific coding on request

## Adaptor RosenbergerHSD®

Rosenberger No.	Remarks	Coding	Packing Unit	Product
D4K10A-K00A5-Z	RosenbergerHSD® female – female Impedance 100 Ω Frequency range DC to 6 GHz Return loss ≥ 20 dB, DC to 2 GHz Insertion loss ≤ 0.2 dB, DC to 2 GHz Skew ≤ 5 ps Nearend crosstalk ≤ -30 dB, DC to 1 GHz Farend crosstalk ≤ -35 dB, DC to 1 GHz Insulation resistance ≥ 1 x 10 <sup>3</sup> MΩ Signal contact resistance ≤ 10 mΩ Outer contact resistance ≤ 7.5 mΩ Test voltage 250 V rms Working voltage 100 V rms Differential shielding eff. ≥ 75 dB, DC to 1 GHz ≥ 65 dB, 1 GHz to 2 GHz	Z	1	

Test PC-Board RosenbergerHSD® – SMA

Rosenberger No.	Remarks	Packing Unit	Product
PCB-L1501-SB	RosenbergerHSD® male – SMA female (4x) Impedance 100 Ω Frequency range DC to 6 GHz Return loss ≥ 20 dB, DC to 2 GHz Insertion loss ≤ 0.3 dB, DC to 2 GHz Skew ≤ 5 ps Nearend crosstalk ≤ -30 dB, DC to 1 GHz Farend crosstalk ≤ -35 dB, DC to 1 GHz Insulation resistance ≥ 1 x 10 <sup>3</sup> MΩ Signal contact resistance ≤ 10 mΩ Outer contact resistance ≤ 7.5 mΩ Test voltage 250 V rms Working voltage 100 V rms  Test PC-Boards for electrical evaluations are available on request	1	

Repair Tool Kit RosenbergerHSD®

Rosenberger No.	Remarks	Packing Unit	Product
D4W006-SET	Complete tool kit incl. following content	1	
59W010-000	Basic tool small		
59W011-000	Basic tool large		
D4K101-1D5/40Z	Crimp sleeves for replacement, 250 pcs		
D4W001-000	Repair tool for replacing RosenbergerHSD® right angle housings		
D4W002-000	Repair tool for replacing RosenbergerHSD® waterproof housings		
D4W003-000	Crimping tool for RosenbergerHSD® crimp sleeves		
D4W004-000	Tool for fixing RosenbergerHSD® center contacts into the dielectric		
D4W006-000	Cable stripping tool		
D4W007-000	Crimping tool for RosenbergerHSD® center contacts		
D4W008-000	Crimping tool for RosenbergerHSD® outer contacts		

Repair Tool Kit RosenbergerHSD®

Rosenberger No.	Remarks	Packing Unit	Product
D4W0A6-SET	Complete tool kit incl. following content	1	
D4W0A3-1D5	Crimping tool for straight center contacts		
D4W0A6-1D5	Stripping tool for cable jacket		
D4W0A8-1D5	Crimping tool for support sleeves		
D4W0B6-1D5	Stripping tool for cable conductors		

# Cable Assemblies

Rosenberger offers a comprehensive range of standard cable assemblies as well as customized solutions for high-speed data transmissions.







Cable variants with 0.14 mm<sup>2</sup> and 0.5 mm<sup>2</sup> center contact sections are used. There are semi- and fully-shielded cable variants for RosenbergerHSD<sup>®</sup> system as well shielded cables for the RosenbergerHSD<sup>®t</sup> connectors available.

Customer-specific versions on request, please feel free to contact us.

## Rosenberger Number Code – Cable Assemblies RosenbergerHSD<sup>®</sup>/HSD<sup>®t</sup>

L	xx-	101-	xxxx-	-y-y	(_ flex)
					add if flexible cable
					Coding Side A and B
					A, B, C, D, E, F, Z, G, H, J, K, L, M, O
					y Placeholder for required coding
					Length in mm
					Successive number,
					Include assembled connectors,
					for details please see data sheet
					Cable group
					D5 e.g. G&G K6750, LEONI Dacar <sup>®</sup> 535, 535-2 (flex), 636, 636-2 (flex)
					D9 e.g. LEONI Dacar 686-3
					AF e.g. G&G X6238, LEONI Dacar <sup>®</sup> 566
					AQ e.g. G&G 2Speed <sup>®</sup> 132, LEONI Dacar 676
					AU e.g. G&G X9207
					Cable assembly

Procedure for the Selection of the Appropriate Cable Assemblies – Example

<p>1. Allocate to the PCB connectors the regarding Side A and B.</p>	<p><b>Side A - Ermitter</b></p> 	<p><b>Side B - Receiver</b></p> 
<p>2. Choose mating connector, plug or jack. 3. Choose orientation, straight or right angle (90°).</p>	<p>Jack 90°</p> 	<p>Jack 90°</p>
<p>4. Allocate to each side the cable exit.</p>	<p>Cable Exit right</p> 	<p>Cable Exit left</p> 
<p>5. Find the matching descriptions in the columns "Side A" and "Side B" on the following pages.</p>	<p>Side A, Jack, 90°, cable left</p> 	<p>Side B, Jack, 90°, cable right</p>

Example: Rosenberger No. LD5-228-xxxx-y-y



### Cable Assemblies RosenbergerHSD®





Rosenberger No.	Remarks	Cable Group	Side A	Side B	Product
LD5-101-xxxx-y-y LAF-101-xxxx-y-y	xxxx: length in mm y-y: coding side A/B	D5 AF	Jack, straight A, B, C, D, E, F, Z	Jack, straight A, B, C, D, E, F, Z	
LD5-102-xxxx-y-y LAF-102-xxxx-y-y	xxxx: length in mm y-y: coding side A/B	D5 AF	Jack, straight A, B, C, D, E, F, Z	Plug, straight A, B, C, D, E, F, Z	
LD5-103-xxxx-y-y LAF-103-xxxx-y-y	xxxx: length in mm y-y: coding side A/B	D5 AF	Plug, straight A, B, C, D, E, F, Z	Jack, straight A, B, C, D, E, F, Z	
LD5-104-xxxx-y-y LAF-104-xxxx-y-y	xxxx: length in mm y-y: coding side A/B	D5 AF	Plug, straight A, B, C, D, E, F, Z	Plug, straight A, B, C, D, E, F, Z	

### Cable Assemblies RosenbergerHSD®t

Rosenberger No.	Remarks	Cable Group	Side A	Side B	
LD9-101-xxxx-y-y	xxxx: length in mm y-y: coding side A/B	D9	Jack, straight A, B, C, D, E, F, Z	Jack, straight A, B, C, D, E, F, Z	
LD9-102-xxxx-y-y	xxxx: length in mm y-y: coding side A/B	D9	Jack, straight A, B, C, D, E, F, Z	Plug, straight A, B, C, D, E, F, Z	
LD9-103-xxxx-y-y	xxxx: length in mm y-y: coding side A/B	D9	Plug, straight A, B, C, D, E, F, Z	Jack, straight A, B, C, D, E, F, Z	
LD9-104-xxxx-y-y	xxxx: length in mm y-y: coding side A/B	D9	Plug, straight A, B, C, D, E, F, Z	Plug, straight A, B, C, D, E, F, Z	



## Cable Assemblies RosenbergerHSD® Waterproof

Rosenberger No.	Remarks	Cable Group	Side A	Side B	Product
LD5-105-xxxx-y-y	xxxx: length in mm y-y: coding side A/B waterproof	D5	Jack, straight A, B, C, D, E, F, Z	Jack, straight A, B, C, D, E, F, Z	
LD5-106-xxxx-y-y	xxxx: length in mm y-y: coding side A/B waterproof	D5	Jack, straight A, B, C, D, E, F, Z	Plug, straight A, B, C, D, E, F, Z	
LD5-107-xxxx-y-y	xxxx: length in mm y-y: coding side A/B waterproof	D5	Plug, straight A, B, C, D, E, F, Z	Jack, straight A, B, C, D, E, F, Z	
LD5-108-xxxx-y-y	xxxx: length in mm y-y: coding side A/B waterproof	D5	Plug, straight A, B, C, D, E, F, Z	Plug, straight A, B, C, D, E, F, Z	

## Cable Assemblies RosenbergerHSD®t Waterproof

Rosenberger No.	Remarks	Cable Group	Side A	Side B	
LD9-105-xxxx-y-y	xxxx: length in mm y-y: coding side A/B waterproof	D9	Jack, straight A, B, C, D, E, F, Z	Jack, straight A, B, C, D, E, F, Z	
LD9-106-xxxx-y-y	xxxx: length in mm y-y: coding side A/B waterproof	D9	Jack, straight A, B, C, D, E, F, Z	Plug, straight A, B, C, D, E, F, Z	
LD9-107-xxxx-y-y	xxxx: length in mm y-y: coding side A/B waterproof	D9	Plug, straight A, B, C, D, E, F, Z	Jack, straight A, B, C, D, E, F, Z	
LD9-108-xxxx-y-y	xxxx: length in mm y-y: coding side A/B waterproof	D9	Plug, straight A, B, C, D, E, F, Z	Plug, straight A, B, C, D, E, F, Z	



### Cable Assemblies RosenbergerHSD®

Rosenberger No.	Remarks	Cable Group	Side A	Side B	Product
LD5-201-xxxx-y-y LAF-201-xxxx-y-y	xxxx: length in mm y-y: coding side A/B	D5 AF	Jack, straight A, B, C, D, E, F, Z	Jack, 90° cable down A, B, C, D, E, F, Z	
LD5-202-xxxx-y-y LAF-202-xxxx-y-y	xxxx: length in mm y-y: coding side A/B side B: only mateable with plugs, <b>cable up</b>	D5 AF	Jack, straight A, B, C, D, E, F, Z	Jack, 90° <b>cable up</b> G, H, J, K, L, M, O	
LD5-203-xxxx-y-y LAF-203-xxxx-y-y	xxxx: length in mm y-y: coding side A/B	D5 AF	Jack, straight A, B, C, D, E, F, Z	Jack, 90° cable left A, B, C, D, E, F, Z	
LD5-204-xxxx-y-y LAF-204-xxxx-y-y	xxxx: length in mm y-y: coding side A/B	D5 AF	Jack, straight A, B, C, D, E, F, Z	Jack, 90° cable right A, B, C, D, E, F, Z	

### Cable Assemblies RosenbergerHSD®t

Rosenberger No.	Remarks	Cable Group	Side A	Side B	
LD9-201-xxxx-y-y	xxxx: length in mm y-y: coding side A/B	D9	Jack, straight A, B, C, D, E, F, Z	Jack, 90° cable down A, B, C, D, E, F, Z	
LD9-202-xxxx-y-y	xxxx: length in mm y-y: coding side A/B side B: only mateable with plugs, <b>cable up</b>	D9	Jack, straight A, B, C, D, E, F, Z	Jack, 90° <b>cable up</b> G, H, J, K, L, M, O	
LD9-203-xxxx-y-y	xxxx: length in mm y-y: coding side A/B	D9	Jack, straight A, B, C, D, E, F, Z	Jack, 90° cable left A, B, C, D, E, F, Z	



Cable Assemblies RosenbergerHSD®

Rosenberger No.	Remarks	Cable Group	Side A	Side B	Product
LD5-205-xxxx-y-y LAF-205-xxxx-y-y	xxxx: length in mm y-y: coding side A/B	D5 AF	Plug, straight A, B, C, D, E, F, Z	Jack, 90° cable down A, B, C, D, E, F, Z	
LD5-206-xxxx-y-y LAF-206-xxxx-y-y	xxxx: length in mm y-y: coding side A/B side B: only mateable with plugs, <b>cable up</b>	D5 AF	Plug, straight A, B, C, D, E, F, Z	Jack, 90° <b>cable up</b> G, H, J, K, L, M, O	
LD5-207-xxxx-y-y LAF-207-xxxx-y-y	xxxx: length in mm y-y: coding side A/B	D5 AF	Plug, straight A, B, C, D, E, F, Z	Jack, 90° cable left A, B, C, D, E, F, Z	
LD5-208-xxxx-y-y LAF-208-xxxx-y-y	xxxx: length in mm y-y: coding side A/B	D5 AF	Plug, straight A, B, C, D, E, F, Z	Jack, 90° cable right A, B, C, D, E, F, Z	

Cable Assemblies RosenbergerHSD®t

Rosenberger No.	Remarks	Cable Group	Side A	Side B	
LD9-205-xxxx-y-y	xxxx: length in mm y-y: coding side A/B	D9	Plug, straight A, B, C, D, E, F, Z	Jack, 90° cable down A, B, C, D, E, F, Z	
LD9-206-xxxx-y-y	xxxx: length in mm y-y: coding side A/B side B: only mateable with plugs, <b>cable up</b>	D9	Plug, straight A, B, C, D, E, F, Z	Jack, 90° <b>cable up</b> G, H, J, K, L, M, O	



### Cable Assemblies RosenbergerHSD®

Rosenberger No.	Remarks	Cable Group	Side A	Side B	Product
LD5-209-xxxx-y-y LAF-209-xxxx-y-y	xxxx: length in mm y-y: coding side A/B	D5 AF	Jack, 90° cable down A, B, C, D, E, F, Z	Jack, straight A, B, C, D, E, F, Z	
LD5-210-xxxx-y-y LAF-210-xxxx-y-y	xxxx: length in mm y-y: coding side A/B side A: only mateable with plugs, <b>cable up</b>	D5 AF	Jack, 90° <b>cable up</b> G, H, J, K, L, M, O	Jack, straight A, B, C, D, E, F, Z	
LD5-211-xxxx-y-y LAF-211-xxxx-y-y	xxxx: length in mm y-y: coding side A/B	D5 AF	Jack, 90° cable right A, B, C, D, E, F, Z	Jack, straight A, B, C, D, E, F, Z	
LD5-212-xxxx-y-y LAF-212-xxxx-y-y	xxxx: length in mm y-y: coding side A/B	D5 AF	Jack, 90° cable left A, B, C, D, E, F, Z	Jack, straight A, B, C, D, E, F, Z	

### Cable Assemblies RosenbergerHSD®t

Rosenberger No.	Remarks	Cable Group	Side A	Side B	
LD9-209-xxxx-y-y	xxxx: length in mm y-y: coding side A/B	D9	Jack, 90° cable down A, B, C, D, E, F, Z	Jack, straight A, B, C, D, E, F, Z	
LD9-210-xxxx-y-y	xxxx: length in mm y-y: coding side A/B side A: only mateable with plugs, <b>cable up</b>	D9	Jack, 90° <b>cable up</b> G, H, J, K, L, M, O	Jack, straight A, B, C, D, E, F, Z	



Cable Assemblies RosenbergerHSD®





Rosenberger No.	Remarks	Cable Group	Side A	Side B	Product
LD5-213-xxxx-y-y LAF-213-xxxx-y-y	xxxx: length in mm y-y: coding side A/B	D5 AF	Jack, 90° cable down A, B, C, D, E, F, Z	Plug, straight A, B, C, D, E, F, Z	
LD5-214-xxxx-y-y LAF-214-xxxx-y-y	xxxx: length in mm y-y: coding side A/B side A: only mateable with plugs, <b>cable up</b>	D5 AF	Jack, 90° <b>cable up</b> G, H, J, K, L, M, O	Plug, straight A, B, C, D, E, F, Z	
LD5-215-xxxx-y-y LAF-215-xxxx-y-y	xxxx: length in mm y-y: coding side A/B	D5 AF	Jack, 90° cable right A, B, C, D, E, F, Z	Plug, straight A, B, C, D, E, F, Z	
LD5-216-xxxx-y-y LAF-216-xxxx-y-y	xxxx: length in mm y-y: coding side A/B	D5 AF	Jack, 90° cable left A, B, C, D, E, F, Z	Plug, straight A, B, C, D, E, F, Z	

Cable Assemblies RosenbergerHSD®t

Rosenberger No.	Remarks	Cable Group	Side A	Side B	
LD9-213-xxxx-y-y	xxxx: length in mm y-y: coding side A/B	D9	Jack, 90° cable down A, B, C, D, E, F, Z	Plug, straight A, B, C, D, E, F, Z	
LD9-214-xxxx-y-y	xxxx: length in mm y-y: coding side A/B side A: only mateable with plugs, <b>cable up</b>	D9	Jack, 90° <b>cable up</b> G, H, J, K, L, M, O	Plug, straight A, B, C, D, E, F, Z	



### Cable Assemblies RosenbergerHSD®





Rosenberger No.	Remarks	Cable Group	Side A	Side B	Product
LD5-217-xxxx-y-y LAF-217-xxxx-y-y	xxxx: length in mm y-y: coding side A/B	D5 AF	Jack, 90° cable down A, B, C, D, E, F, Z	Jack, 90° cable down A, B, C, D, E, F, Z	
LD5-218-xxxx-y-y LAF-218-xxxx-y-y	xxxx: length in mm y-y: coding side A/B side A: only mateable with plugs, <b>cable up</b>	D5 AF	Jack, 90° <b>cable up</b> <b>G, H, J, K, L, M, O</b>	Jack, 90° cable down A, B, C, D, E, F, Z	
LD5-219-xxxx-y-y LAF-219-xxxx-y-y	xxxx: length in mm y-y: coding side A/B	D5 AF	Jack, 90° cable right A, B, C, D, E, F, Z	Jack, 90° cable down A, B, C, D, E, F, Z	
LD5-220-xxxx-y-y LAF-220-xxxx-y-y	xxxx: length in mm y-y: coding side A/B	D5 AF	Jack, 90° cable left A, B, C, D, E, F, Z	Jack, 90° cable down A, B, C, D, E, F, Z	

### Cable Assemblies RosenbergerHSD®t

Rosenberger No.	Remarks	Cable Group	Side A	Side B	
LD9-217-xxxx-y-y	xxxx: length in mm y-y: coding side A/B	D9	Jack, 90° cable down A, B, C, D, E, F, Z	Jack, 90° cable down A, B, C, D, E, F, Z	
LD9-218-xxxx-y-y	xxxx: length in mm y-y: coding side A/B side A: only mateable with plugs, <b>cable up</b>	D9	Jack, 90° <b>cable up</b> <b>G, H, J, K, L, M, O</b>	Jack, 90° cable down A, B, C, D, E, F, Z	



Cable Assemblies RosenbergerHSD®

Rosenberger No.	Remarks	Cable Group	Side A	Side B	Product
LD5-221-xxxx-y-y LAF-221-xxxx-y-y	xxxx: length in mm y-y: coding side A/B side B: only mateable with plugs, <b>cable up</b>	D5 AF	Jack, 90° cable down A, B, C, D, E, F, Z	Jack, 90° <b>cable up</b> G, H, J, K, L, M, O	
LD5-222-xxxx-y-y LAF-222-xxxx-y-y	xxxx: length in mm y-y: coding side A/B: only mateable with plugs, <b>cable up</b>	D5 AF	Jack, 90° <b>cable up</b> G, H, J, K, L, M, O	Jack, 90° <b>cable up</b> G, H, J, K, L, M, O	
LD5-223-xxxx-y-y LAF-223-xxxx-y-y	xxxx: length in mm y-y: coding side A/B side B: only mateable with plugs, <b>cable up</b>	D5 AF	Jack, 90° cable right A, B, C, D, E, F, Z	Jack, 90° <b>cable up</b> G, H, J, K, L, M, O	
LD5-224-xxxx-y-y LAF-224-xxxx-y-y	xxxx: length in mm y-y: coding side A/B side B: only mateable with plugs, <b>cable up</b>	D5 AF	Jack, 90° cable left A, B, C, D, E, F, Z	Jack, 90° <b>cable up</b> G, H, J, K, L, M, O	

Cable Assemblies RosenbergerHSD®t

Rosenberger No.	Remarks	Cable Group	Side A	Side B	
LD9-221-xxxx-y-y	xxxx: length in mm y-y: coding side A/B side B: only mateable with plugs, <b>cable up</b>	D9	Jack, 90° cable down A, B, C, D, E, F, Z	Jack, 90° <b>cable up</b> G, H, J, K, L, M, O	
LD9-222-xxxx-y-y	xxxx: length in mm y-y: coding side A/B: only mateable with plugs, <b>cable up</b>	D9	Jack, 90° <b>cable up</b> G, H, J, K, L, M, O	Jack, 90° <b>cable up</b> G, H, J, K, L, M, O	



Cable Assemblies RosenbergerHSD®

Rosenberger No.	Remarks	Cable Group	Side A	Side B	Product
LD5-225-xxxx-y-y LAF-225-xxxx-y-y	xxxx: length in mm y-y: coding side A/B	D5 AF	Jack, 90° cable down A, B, C, D, E, F, Z	Jack, 90° cable right A, B, C, D, E, F, Z	
LD5-226-xxxx-y-y LAF-226-xxxx-y-y	xxxx: length in mm y-y: coding side A/B side A: only mateable with plugs, <b>cable up</b>	D5 AF	Jack, 90° <b>cable up</b> <b>G, H, J, K, L, M, O</b>	Jack, 90° cable right A, B, C, D, E, F, Z	
LD5-227-xxxx-y-y LAF-227-xxxx-y-y	xxxx: length in mm y-y: coding side A/B	D5 AF	Jack, 90° cable right A, B, C, D, E, F, Z	Jack, 90° cable right A, B, C, D, E, F, Z	
LD5-228-xxxx-y-y LAF-228-xxxx-y-y	xxxx: length in mm y-y: coding side A/B	D5 AF	Jack, 90° cable left A, B, C, D, E, F, Z	Jack, 90° cable right A, B, C, D, E, F, Z	



Cable Assemblies RosenbergerHSD®

Rosenberger No.	Remarks	Cable Group	Side A	Side B	Product
LD5-229-xxxx-y-y LAF-229-xxxx-y-y	xxxx: length in mm y-y: coding side A/B	D5 AF	Jack, 90° cable down A, B, C, D, E, F, Z	Jack, 90° cable left A, B, C, D, E, F, Z	
LD5-230-xxxx-y-y LAF-230-xxxx-y-y	xxxx: length in mm y-y: coding side A/B side A: only mateable with plugs, <b>cable up</b>	D5 AF	Jack, 90° <b>cable up</b> <b>G, H, J, K, L, M, O</b>	Jack, 90° cable left A, B, C, D, E, F, Z	
LD5-231-xxxx-y-y LAF-231-xxxx-y-y	xxxx: length in mm y-y: coding side A/B	D5 AF	Jack, 90° cable right A, B, C, D, E, F, Z	Jack, 90° cable left A, B, C, D, E, F, Z	
LD5-232-xxxx-y-y LAF-232-xxxx-y-y	xxxx: length in mm y-y: coding side A/B	D5 AF	Jack, 90° cable left A, B, C, D, E, F, Z	Jack, 90° cable left A, B, C, D, E, F, Z	

# Technical References

## The RosenbergerHSD® Concept – Data Transmission on Copper Cables

The RosenbergerHSD® system for transmission of low and high bit rate data streams is based on the star-quad principle and was originally developed for the automotive industry. The system provides two differential signal pairs decoupled from each other. The graph below illustrates an overview of applicable protocols. Furthermore, the control signals from bus systems (LIN, CAN) can be integrated, so that an individual RosenbergerHSD® cable allows transmitting several signals in a type of "Micro-Cable-Harness" Configuration, including (remote) power supply. When combined with high-quality copper conductor cables, the RosenbergerHSD® system is compliant to the highest mechanical and electrical requirements of the automotive industry.

The electromagnetic compatibility (EMC), which is of particular relevance due to the large number of neighboring communication systems in the automotive industry is provided by a high degree of shielding efficiency. Additionally, partly and fully unshielded solutions are available, where the relevant transmission characteristics are compliant even with the most stringent cost requirements.

Since 2006, when leading car manufacturers defined the High-Speed-Data (HSD) connector system together with Rosenberger based on the star-quad concept with 0.14 mm<sup>2</sup> (AWG26) cables, this open 100-Ω-system became the de facto standard for data transmission in vehicles.

This kind of topology saves costs, weight and precious space. Because of the large market share and the resulting increase in production volume the costs for the RosenbergerHSD®-system – consisting of PCB-interconnects and cable-assemblies – decreased immensely since the introduction. As for coaxial cables highly automated manufacturing and assembly processes guarantee a stable high quality.

The close collaboration with leading semiconductor-, cable manufacturers and fabricators allows an ongoing further development of the RosenbergerHSD® system through innovative solutions. Rosenberger takes high efforts in research and development on the basics of signal transmission (from PHY to PHY) regarding signal integrity und electromagnetic compatibility (EMC) including RF optimized signal paths in the PCB layout. Therefore, Rosenberger acts as a competent partner for customers throughout the product life cycle, starting with the concept and design-in phase.

With the introduction of RosenbergerHSD®t the selection kit has been expanded consistently towards automotive Ethernet solutions. Therewith there is now the possibility to introduce e.g. unshielded automotive Ethernet in cars based on 0.14 mm<sup>2</sup> (AWG26) cables with backward compatibility towards the screened RosenbergerHSD®t system.

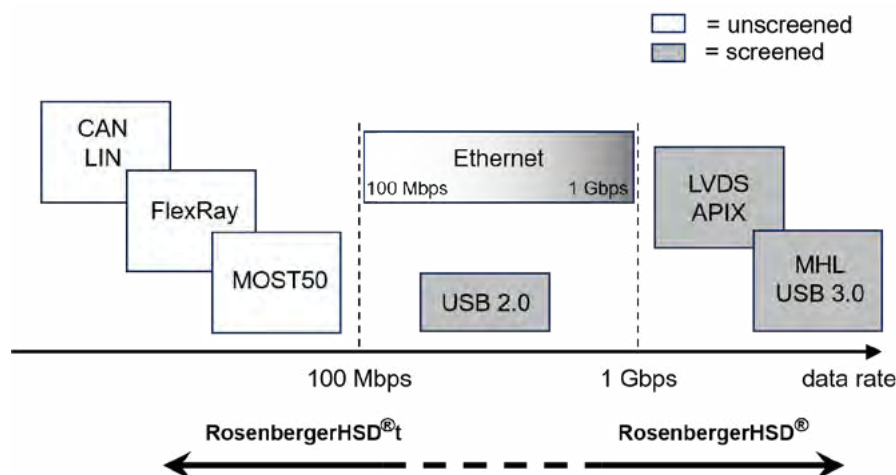

## RosenbergerHSD® Selection Kit

The so-called RosenbergerHSD® selection kit consists of different connector interfaces:

### RosenbergerHSD®

The standard RosenbergerHSD® has been established for years in the automotive industry. RosenbergerHSD® and RosenbergerHSD®t are mechanically compatible to each other.

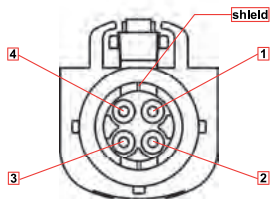

### RosenbergerHSD®double 8 mm, 12.7 mm

For high-speed transmissions such as USB 3.0, with the two star-quad cables, which can be connected in the tightest of installation spaces.

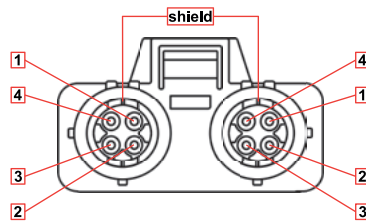
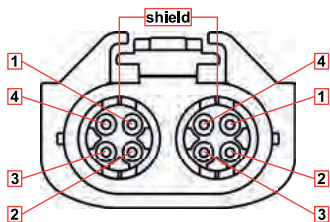

### RosenbergerHSD®+2, +4, +8

Variants with additional pins (MQS contacts) for power supply purposes.

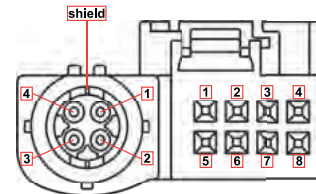
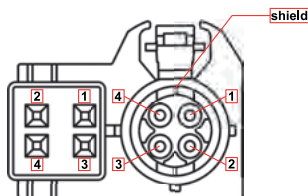
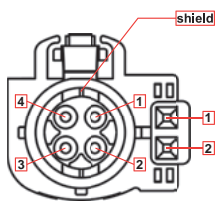

### RosenbergerHSD®t

RosenbergerHSD®t connectors are using just one data pair, they are available in two versions to suit shielded (STP) as well as unshielded (UTP) twisted pair cables.

Featuring the well-known piece parts of the standard RosenbergerHSD® system they are very cost efficient high-speed data connectors. The RosenbergerHSD®t are used in Ethernet applications and fulfill the very high requirements of the automotive industry.

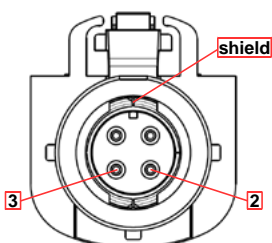

STP

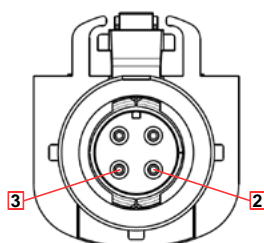

UTP

## Cables

The RosenbergerHSD® system facilitates combination of the most diverse cable types and different conductor cross-sections. Cable variants with 0.14 mm<sup>2</sup> and 0.5 mm<sup>2</sup> center contact cross-sections are used in conjunction with the RosenbergerHSD®.

For the standard RosenbergerHSD®, there are semi- and fully-shielded cable variants available. Semi-shielded variants feature only a single drain wire in some cases, but usually a foil shield. Fully-shielded cables are usually enclosed in a braided or helical shield. Furthermore, CAT qualifications to EN 50173 are performed with the cable links, whereby compliance to the limits for CAT5 respectively CAT6a is observed, depending on the cable configuration. In addition to compliance of the signal transmission properties to the CAT standard, the EMC performance, which is determined mainly by the cable, must be examined in detail.

If required, please ask for the suitable cables for your application, we will advise you.

### RosenbergerHSD® – Standard cable, shielded

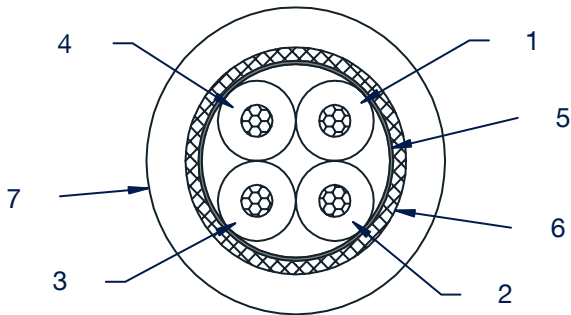

- 1-4 Conductor with insulation, stranded
- 5 Foil
- 6 Shield
- 7 Jacket

### RosenbergerHSD® – Flexible cable, shielded

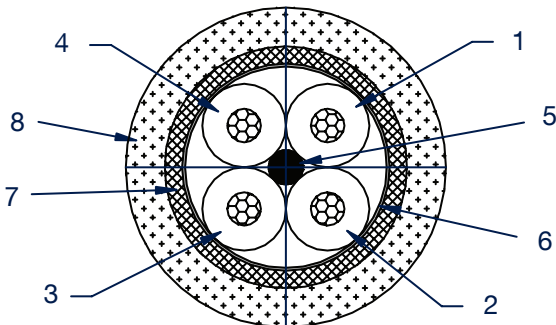

- 1-4 Conductor with insulation, stranded
- 5 Filler
- 6 Foil
- 7 Shield
- 8 Jacket

### RosenbergerHSD®t

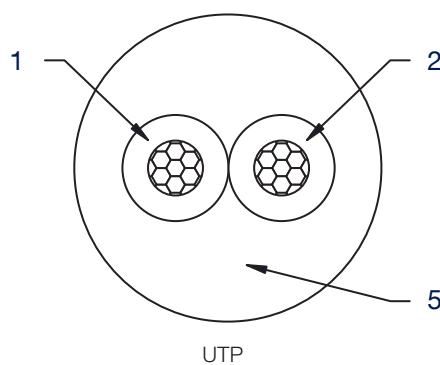
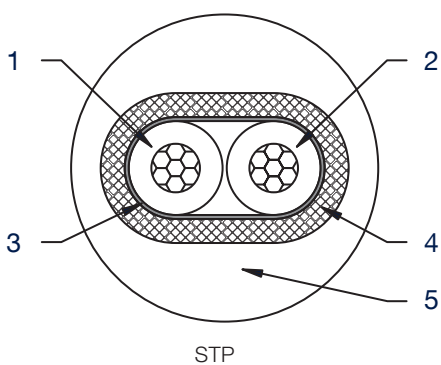

- 1-2 Conductor with insulation, stranded
- 3 Foil
- 4 Shield
- 5 Jacket

## The Cable Design – Arrangement of Two Differential Pairs

### From twisted-pair to star-quad

With a twisted pair, the conductors are twisted directly around each other. The greatest advantage of a twisted pair is that they mutually, and almost completely, cancel out the influence of external fields that might induce a voltage difference between both conductors. On the other hand also without the presence of an external field those common mode components are averaged out due to the twisting, that result for example from excitation by the asymmetric geometric position of the cable with respect to the neighboring ground conductors. These properties are of particular interest from the point of view of electromagnetic compatibility (EMC), as it is only possible to guarantee low interference from unshielded twisted-pair cables in this manner.

Considering not just one but two pairs, there are two different possibilities available to arrange the individual conductors. On the one hand, the pairs can be individually twisted and both twisted-pairs can be stranded yet again. This process is known as the Dieselhorst-Martin quad, and is mainly used for multi-pair earth cables. On the other hand, it is possible to directly strand the four individual conductors while observing the symmetry of the star-shaped cross-section configuration. The decisive benefits of the star-quad compared to Dieselhorst-Martin stranding is the simpler and more cost-effective production, the smaller external diameter and ability for an automated assembly process. This is why the RosenbergerHSD® system has been consistently designed for cables with star-shaped stranding of twin pairs.

### Star-quad topology

Two diagonally opposed conductors in the star-quad form a differential wire pair. In this way there is always a balanced pair on the virtual ground plane of what is the second pair. This results in high crosstalk attenuation, and at the same time the cable is as compact as possible. Maximum crosstalk attenuation is necessary for transmission of broadband datastreams on the two wire pairs independently of one another and without harmful interference between them. Depending on the demands for the shielding effectiveness of the cable assembly, both pairs in a star-quad can be

- enclosed by a common braided or helical shield in addition to a foil shielding (fully-shielded),
- equipped with just one foil shield with/without drain wire (semi-shielded) or
- fully unshielded.

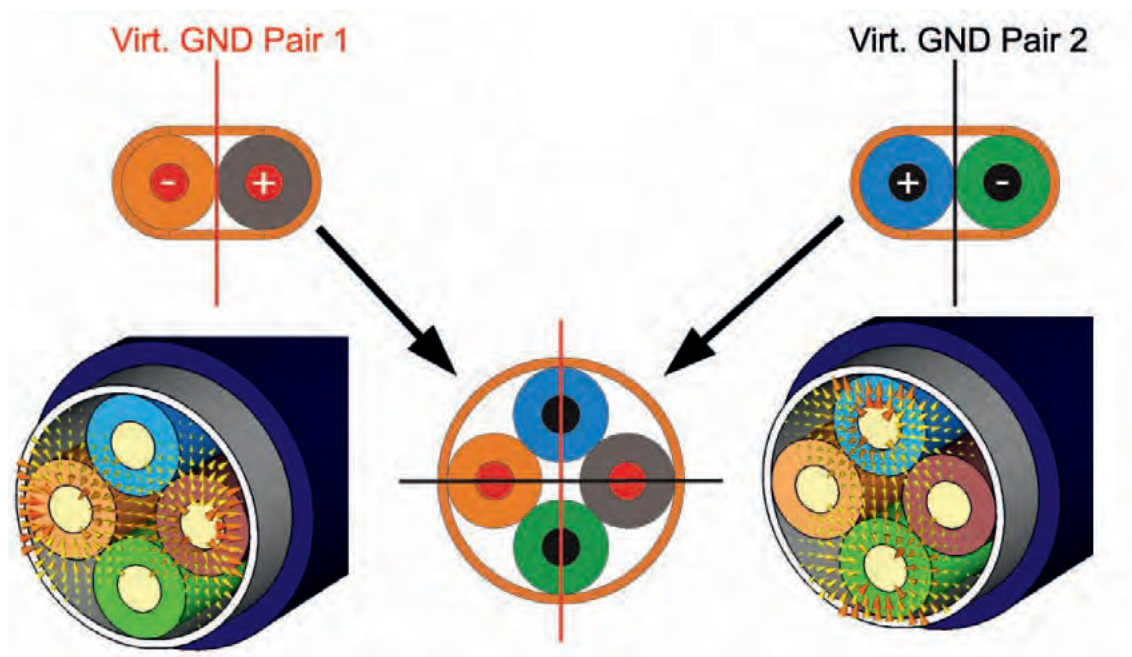

Arrangement of the conductors of two differential pairs in a shielded star-quad

## Power over HSD (PoH)

Power over HSD (PoH) is a concept for remote power supply, for example, to displays, cameras or similar devices. In addition to the data signal DC is transmitted on separate conductors in order to supply the terminal device with power. Using the RosenbergerHSD®+2 as an example, different current feed variants are shown.

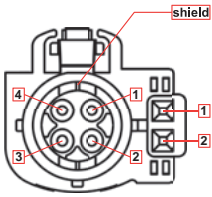

With a center conductor cross-section of  $0.14 \text{ mm}^2$  and the specific resistance for copper the resistance per unit length  $R'_{\text{cond}}$  is determined to approx.  $125 \text{ } \Omega/\text{km}$  for the center conductor. The value for the shield  $R'_{\text{screen}}$  is approx.  $20 \text{ } \Omega/\text{km}$ . This allows to calculate the resulting resistances per unit length for the following variants:

Version	Pin assignment (recommended)	Resistance load per unit length ( $\Omega/\text{km}$ )
1	Pin 2 Vcc, Pin 4 GND	$2 \times R'_{\text{cond}}$
2	Pin 2 Vcc, Pin 4 & Screen GND	$(R'_{\text{cond}} + R'_{\text{screen}} \parallel R'_{\text{cond}})^2$
3	Pin 2 Vcc, Screen GND	$(R'_{\text{cond}} + R'_{\text{screen}})$
4	Pin 2+4 Vcc, Screen GND	$(R'_{\text{cond}}/2 + R'_{\text{screen}})$
5	MQS Pin 1 Vcc, MQS Pin 2 GND	$2 \times R'_{\text{MQS}}$ (MQS conductor)

The values stated in the table are not specifically for  $0.14 \text{ mm}^2$ , as they can also be applied to  $0.35$  and  $0.5 \text{ mm}^2$  inner conductor cross-sections. The conductor resistance is proportional to the reciprocal value of the cross-section, i.e. for  $0.35 \text{ mm}^2$  the conductor resistance is reduced according to the ratio  $0.14/0.35$  to 40 % of the value for  $0.14 \text{ mm}^2$ . For  $0.5 \text{ mm}^2$  it results in a value of 28 %.

With known center conductor cross-section and cable lengths, the resulting series resistance for the current supply can be calculated. So the voltage drop respectively the power dissipation can be calculated for a given current.

If e.g. case 4 with a inner conductor cross-section of  $0.35 \text{ mm}^2$  and a current of 1 A is regarded, this results in a maximum permissible cable length for a voltage drop of 0.25 V as follows.

- Inner conductor resistance per unit length  $0.35 \text{ mm}^2$ :  
 $R'_{\text{cond}} = 0.4 \times 125 \text{ } \Omega/\text{km} = 50 \text{ } \Omega/\text{km}$
- Total resistance per unit length:  
 $R' = (R'_{\text{cond}}/2 + R'_{\text{screen}}) = 45 \text{ } \Omega/\text{km}$
- Maximum resistance:  
 $R_{\text{max}} = \Delta U/I = 0.25 \text{ } \Omega$
- Maximum length:  
 $l_{\text{max}} = R_{\text{max}}/R' = 5.55 \text{ m}$

<sup>2</sup>||" stands for parallel connection of resistors, i.e.  $X \parallel Y = (X \cdot Y)/(X + Y)$

## Power Supply on the Data Pair

In addition to the possibilities mentioned for separate power supply transmission, it is possible to allow the power supply to operate via the same pair when DC voltage free data transfer is considered. Here the separation of data and power supply is achieved by chokes and capacitors.

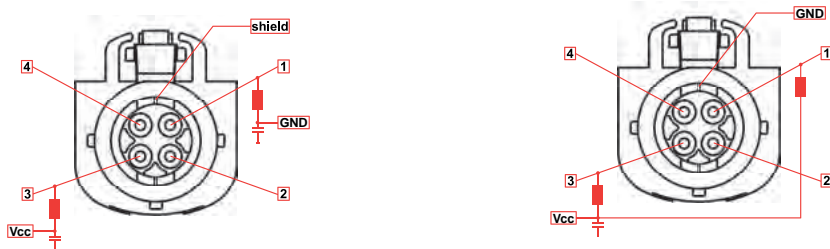

Power supply on the data pair

For higher currents, a pair can be used in parallel as a feed conductor and the shield as a return conductor. This is permissible when the powered end device is isolated with respect to ground. If GND and earth are NOT separate in the end device, the return currents are split on the end device in accordance to the resistances per unit length.

The decisive dimension for evaluation of the functionality is the screening attenuation, i.e. on fully-shielded variants this configuration with the shield is permissible as a return conductor and is functional in principle.

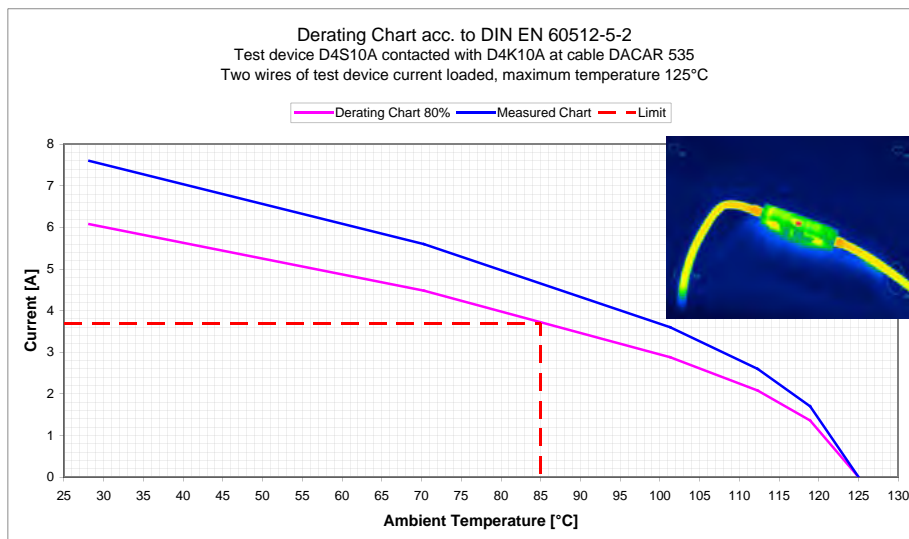

The graph above shows derating curve on RosenbergerHSD® cable inline connection.

For power supply transmission the derating curve must be examined. The curve (pink) is the maximum current load obtained by measurement (blue) at different ambient temperatures with a safety factor of 0.8 (refer to DIN EN 60512-5-2). This means the maximum permissible current can be calculated for every ambient temperature, where the test object does not exceed a temperature of 125 °C. For instance, the maximum permissible ambient temperature of 85 °C results from the current specification of the end user of 3.7 A.

Since version 1 (see page 58) with the biggest resistance has been tested with this derating it can be assumed that all other configurations have an even bigger current carrying capacity.

## Applications and Protocols

Modern vehicles comprise a variety of complex networks and bus systems, providing a large number of security and comfort functions. By combining data and supply power on one single cable, RosenbergerHSD® follows the philosophy of being the most versatile physical data transportation medium within the automotive environment today. Within certain limits it furthermore allows combining different protocols on the same line, forming a "Micro-Cable-Harness"s (e.g. LVDS and CAN). These intelligent configurations help to significantly reduce space, weight, complexity and costs of the cabling harness.

Within this chapter RosenbergerHSD® and RosenbergerHSD®t pinning configurations for frequently used applications and protocols are shown. These pinning configurations are recommendations for the cable "A" and "B"-side and therefore describe the whole data link from device to device. Please consider that several protocols that transmit data unidirectional on a differential pair require a crossing of the pins (e.g. TX+ has to be linked to RX+ on the other side) while bidirectional transmission on one differential pair will link "same" pins (e.g. D+ is linked to D+ on the other side).

### APIX®

APIX® is a high-speed digital serial link for display and camera point-to-point applications. It can provide a bandwidth of up to 3 Gbps in downstream direction over one data pair. The second data pair is used for transmission in upstream direction with lower data rate.

Application	Version	RosenbergerHSD® Side A				RosenbergerHSD® Side B			
		Pin 1	Pin 2	Pin 3	Pin 4	Pin 1	Pin 2	Pin 3	Pin 4
1 x APIX® (2) (3)	RosenbergerHSD®	SDOUT-	SDIN+	SDOUT+	SDIN-	SDOUT-	SDIN+	SDOUT+	SDIN-

### CAN (Controller Area Network)

The RosenbergerHSD® star-quad system allows to transmit CAN Bus data and to provide supply power to a remote device via a single cable. The system can run over RosenbergerHSD® as well as RosenbergerHSD®t.

Application	Version	RosenbergerHSD® Side A				RosenbergerHSD® Side B			
		Pin 1	Pin 2	Pin 3	Pin 4	Pin 1	Pin 2	Pin 3	Pin 4
1 x CAN	RosenbergerHSD®	CAN-L		CAN-H			CAN-H		CAN-L
1 x CAN + Supply Power	RosenbergerHSD®	CAN-L	Vcc	CAN-H	GND	GND	CAN-H	Vcc	CAN-L
1 x CAN	RosenbergerHSD®t		CAN-L	CAN-H			CAN-L	CAN-H	

### LVDS

RosenbergerHSD® is well known to be dedicated to automotive Low Voltage Differential Signal (LVDS) transmission. Due to optimized electrical performance, the system has proven to operate reliably even in the gigabit range. Minimized crosstalk allows running two high-speed data streams or data and supply power on only one cable.

Application	Version	RosenbergerHSD® Side A				RosenbergerHSD® Side B			
		Pin 1	Pin 2	Pin 3	Pin 4	Pin 1	Pin 2	Pin 3	Pin 4
1 x LVDS	RosenbergerHSD®	D+		D-			D-		D+
2 x LVDS	RosenbergerHSD®	D1+	D2-	D1-	D2+	D2+	D1-	D2-	D1+
1 x LVDS + Supply Power	RosenbergerHSD®	DATA+	Vcc	DATA-	GND	GND	DATA-	Vcc	DATA+
1 x LVDS	RosenbergerHSD®t		D+	D-			D+	D-	

### IEEE 802.3 (Ethernet)

A large number of Ethernet protocols are supported by the RosenbergerHSD® system. This ranges from the long existing 100BASE-TX standard using two data pairs to the latest single pair Ethernet (SPE) standards.

RosenbergerHSD® connectors are designed to meet the CAT6a requirements according to IEC 60603-7-51 and OPEN Alliance TC9 STP for RosenbergerHSD® and RosenbergerHSD®t connectors. This ensures the customer to be well prepared for current and future automotive Ethernet applications without the need to change the connector interface. SPE covers the data rates 10BASE-T1, 100BASE-T1 and 1000BASE-T1. If you intend to run multi-gigabit Ethernet according to 2.5/5/10GBASE-T1 please get in contact Rosenberger to discuss the options.

To take full advantage of the star quad system, a SPE link can be combined with DC for remote power supply of devices, e.g. cameras. This significantly reduces cost and complexity of the wiring harness.

Application	Version	RosenbergerHSD® Side A				RosenbergerHSD® Side B			
		Pin 1	Pin 2	Pin 3	Pin 4	Pin 1	Pin 2	Pin 3	Pin 4
1 x 100 BASE-TX	RosenbergerHSD®	TX+	RX-	TX-	RX+	TX+	RX-	TX-	RX+
1 x SPE	RosenbergerHSD®	D+		D-			D-		D+
2 x SPE	RosenbergerHSD®	D1+	D2-	D1-	D2+	D2+	D1-	D2-	D1+
1 x SPE + Supply Power	RosenbergerHSD®	D+	Vcc	D-	GND	GND	D-	Vcc	D+
1 x SPE	RosenbergerHSD®t		D+	D-			D+	D-	

Setting up an Ethernet link according to 1000BASE-T standard is also possible by means of a RosenbergerHSD® double connector. Therefore it is necessary to use two RosenbergerHSD® cables in parallel.

Application	Version	RosenbergerHSD® Side A				RosenbergerHSD® Side B			
		Pin 1	Pin 2	Pin 3	Pin 4	Pin 1	Pin 2	Pin 3	Pin 4
1 x 1000BASE-T	RosenbergerHSD® double	D1+	D2-	D1-	D2+	D2+	D1-	D2-	D1+
		Pin 5	Pin 6	Pin 7	Pin 8	Pin 5	Pin 6	Pin 7	Pin 8
		D3+	D4-	D3-	D4+	D4+	D3-	D4-	D3+

### IEEE 1394 (Firewire)

RosenbergerHSD® is well suited for multimedia IEEE 1394 links. It is designed to transport video and audio with high bandwidth and assured quality of service.

Application	Version	RosenbergerHSD® Side A				RosenbergerHSD® Side B			
		Pin 1	Pin 2	Pin 3	Pin 4	Pin 1	Pin 2	Pin 3	Pin 4
IEEE 1394 (Firewire)	RosenbergerHSD®	TPA+	TPB-	TPA-	TPB+	TPA+	TPB-	TPA-	TPB+

## USB 1.0 and 2.0

Today RosenbergerHSD® is the prevailing media to build up USB links within automotive environment. It supports USB 2.0 in Hi-Speed mode with data rates up to 480 Mbps but also legacy USB 1.0.

USB links comprise one differential data pair for bidirectional communication and one pair of wires for power supply with Vcc +5 V and ground. For longer link length the DC voltage drop along the line must be considered. Therefore it is recommended to connect DC GND to the screen of the cabling, significantly reducing the resistance of the loop. This can be further reduced by using both wires of the power supply wire pair for Vcc, while GND is connected to the cable screen. In both cases configurations, the cable behaves like a coaxial line with inner and outer conductor. This means that the EMC properties of the link are still sufficient, as the screening attenuation of the cable is maintained. In addition cables with larger wire diameter are available, e.g. Dacar 566 or G&G X6238.

Application	Version	RosenbergerHSD® Side A				RosenbergerHSD® Side B			
		Pin 1	Pin 2	Pin 3	Pin 4	Pin 1	Pin 2	Pin 3	Pin 4
1 x USB 2.0 + Supply Power	RosenbergerHSD®	D+	Vcc	D-	GND	GND	D-	Vcc	D+
2 x USB 2.0 + Supply Power	RosenbergerHSD®	D1+	D2-	D1- MQS1 VCC	D2+ MQS- 2GND	D2+	D1-	D2- MQS1 Vcc	D1+ MQS2 GND

## USB 3.0

USB 3.0 is one of the most demanding protocols concerning the physical data channel properties, as its data rate is 5 Gbps (Gen 1). Setting up an USB 3.0 link requires a RosenbergerHSD® double connector. One cable carries the USB 2.0 portion of the link including Hi-Speed data and supply power. The second cable is dedicated to the Super Speed portion of USB 3.0.

Application	Version	RosenbergerHSD® Side A				RosenbergerHSD® Side B			
		Pin 1	Pin 2	Pin 3	Pin 4	Pin 1	Pin 2	Pin 3	Pin 4
1 x USB + Supply Power	RosenbergerHSD® double	DATA+	Vcc	DATA-	GND	GND	DATA-	Vcc	DATA+
		<b>Pin 5</b>	<b>Pin 6</b>	<b>Pin 7</b>	<b>Pin 8</b>	<b>Pin 5</b>	<b>Pin 6</b>	<b>Pin 7</b>	<b>Pin 8</b>
		SSTX+	SSRX-	SSTX-	SSRX+	SSTX+	SSRX-	SSTX-	SSRX+

This only represents a selection of protocols frequently transmitted over RosenbergerHSD®. A lot more protocols, for instance Displayport, Flexray, MHL and so on, can be transmitted over RosenbergerHSD® cable assemblies.

### Layout recommendations

On request, Rosenberger will provide layout recommendations of PCB connectors (footprints) for your specific board stack-up. Please contact the Rosenberger team in order to get an optimized footprint for your application.

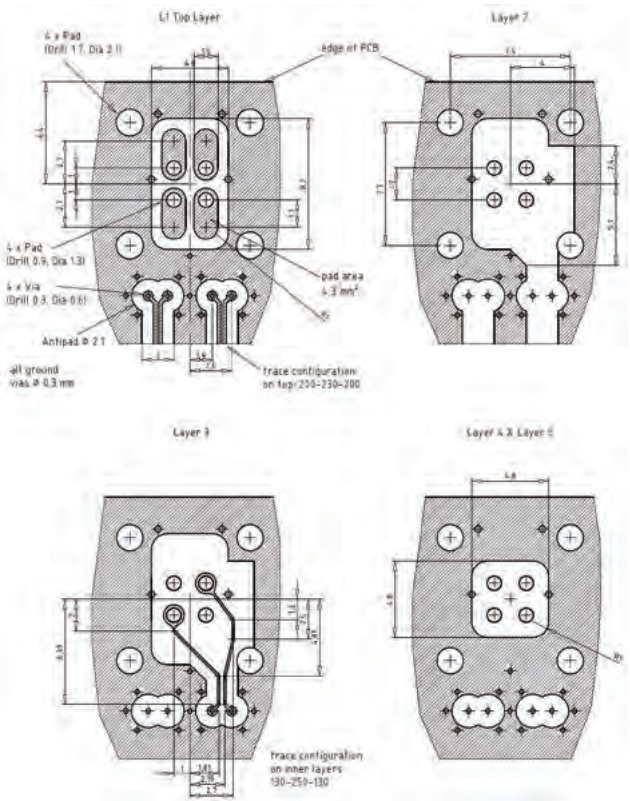
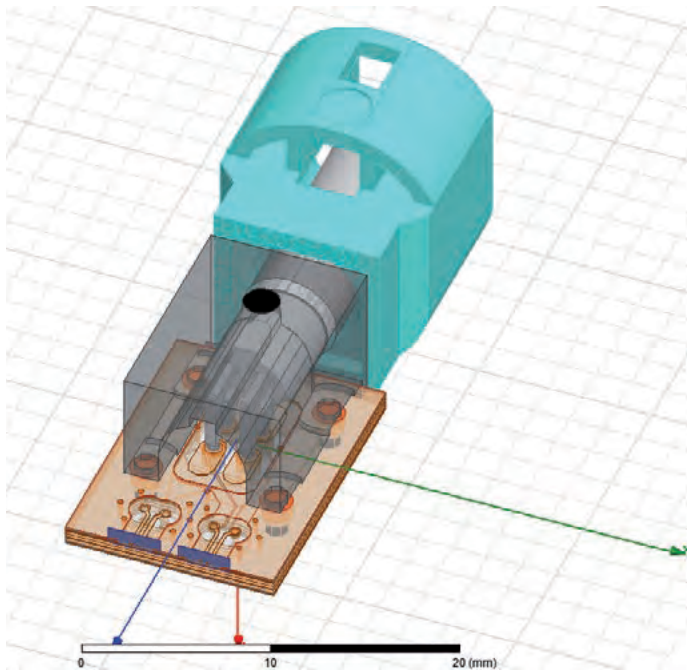

Excerpt of a layout recommendation for a 8-layer-board

Our layout recommendations are optimized regarding signal integrity with the help of 3D FEM simulations. Therefore, skew due to e.g. length differences of the signal pins, which is generated through the use of right angle connectors, is directly compensated by the footprint. Furthermore, we are able to give recommendations for the entire signal path on the board between PCB connector and PHY including coupling capacitors, ESD diodes, common-mode chokes, etc.

## The Principle of Differential Data Transmission

For communication on a line with only one signal conductor, information is transmitted in the form of the potential of the signal conductor referred to ground. This type of information transfer is very sensitive to shifts in ground potential, directly corrupting the communication.

On a balanced line, the communication is transmitted as a potential difference between two signal conductors. In this case, a change of the ground potential through static or dynamic ground currents has the same effect on both signal conductors and can be eliminated in the receiver. It will not influence the transmitted signal.

### Differential signal transfer

A symmetrical conductor structure with two signal conductors can be operated in a so-called common mode or differential mode (DM), refer to Figure 1. Common mode (CM) stands for a common phase (and amplitude) of the signal fed to the two conductors. In differential mode, the signals have a phase shift of  $180^\circ$ , therefore they are in phase opposition.

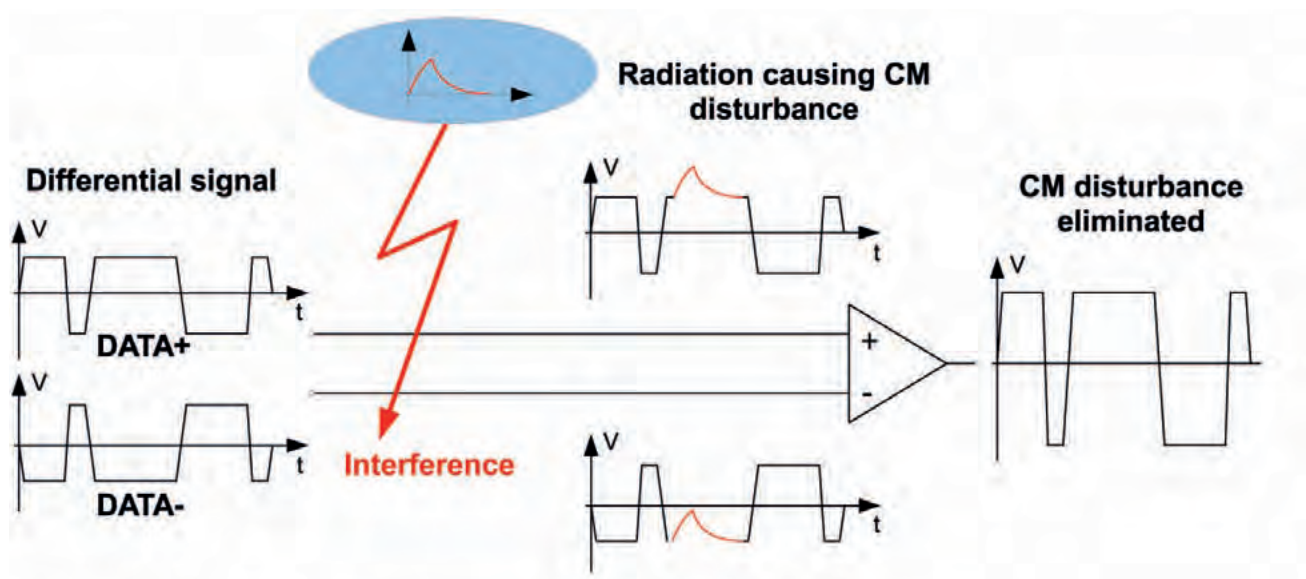

Figure 1: Differential signal transmission

## Common mode (CM) and Differential mode (DM) in detail

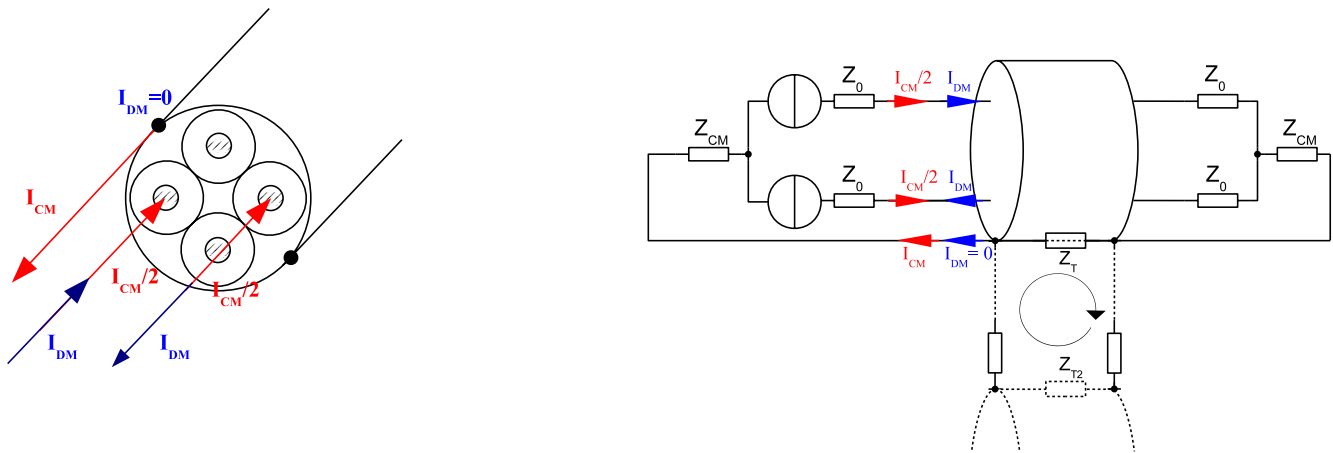

Figure 2: Current paths of Common mode (CM) and Differential mode (DM)

Figure 2 indicates the current direction when the conductor pair is in differential mode (blue) and common mode (red). It is possible to see in differential mode (DM) that one conductor is the feed conductor and the other is the return conductor, and that a return current does not flow on the shield. In common mode (CM), both conductors are more or less connected in parallel as feed conductors and the shield acts as the return conductor. Furthermore, the termination impedances  $Z_0$  of  $50 \Omega$  are shown at both ends of the conductors and the impedances for the CM termination  $Z_{CM}$  are indicated. In addition, the external coupling via the transfer impedance  $Z_T$  is indicated.

The DM waveguide impedance of the pair matches typically the series connection of the termination impedances, i.e.  $2 \times Z_0 = 100 \Omega$ , whereas on the other hand, the CM impedance of the pair should be the same as the parallel connection of the termination impedances  $Z_0$ . Due to coupling between the two inner conductors, this cable impedance is in practice larger than the theoretical value of  $Z_0/2 = 25 \Omega$ .

## Mixed Mode Scattering Parameters

For describing the behavior of 4-Ports for CM/DM excitation, the so-called mixed mode scattering parameters are used in accordance with Figure 3. For the transmission behavior of the pair in differential mode the parameters  $S_{DD21}$  and  $S_{CC21}$  are used. Asymmetry between both conductors of the pair leads to mode conversion. A purely differential signal on the input can, for example, contain a CM component due to different propagation delays on both conductors. This behaviour is described by the parameter  $S_{CD21}$ .

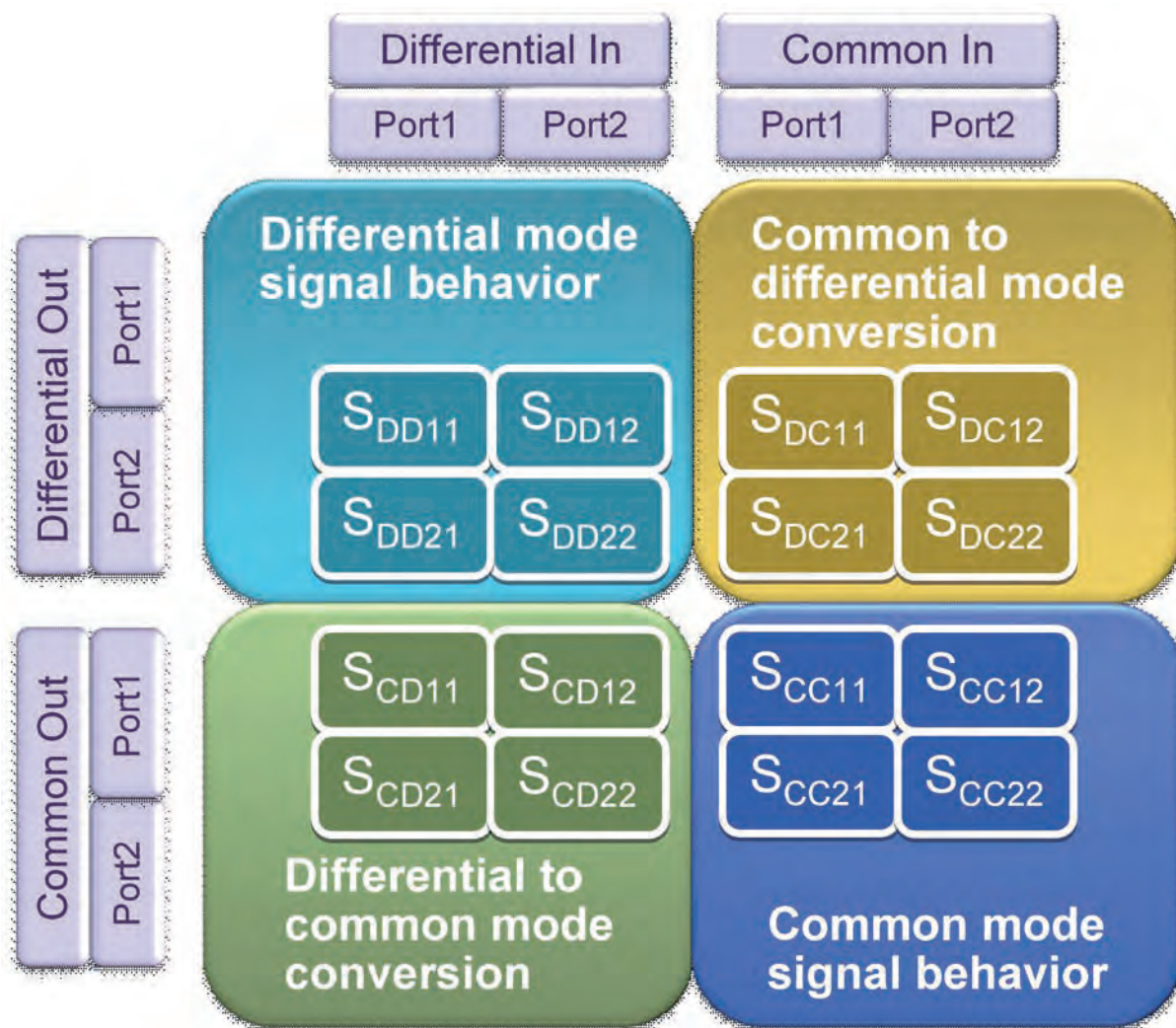

Figure 3: Mixed Mode scattering parameters

## Reflection/Transmission and Crosstalk Measurements

Furthermore, these 4-Port parameters can be used, in addition to the conventional measurement in reflection or transmission direction on the same pair, for the characterization of the crosstalk to the respective other pair on the near and far ends. Figure 4 shows the measurement configuration for reflection/transmission, FEXT<sup>3</sup> and NEXT<sup>4</sup> measurements. All connections not connected are terminated with 50 Ω.

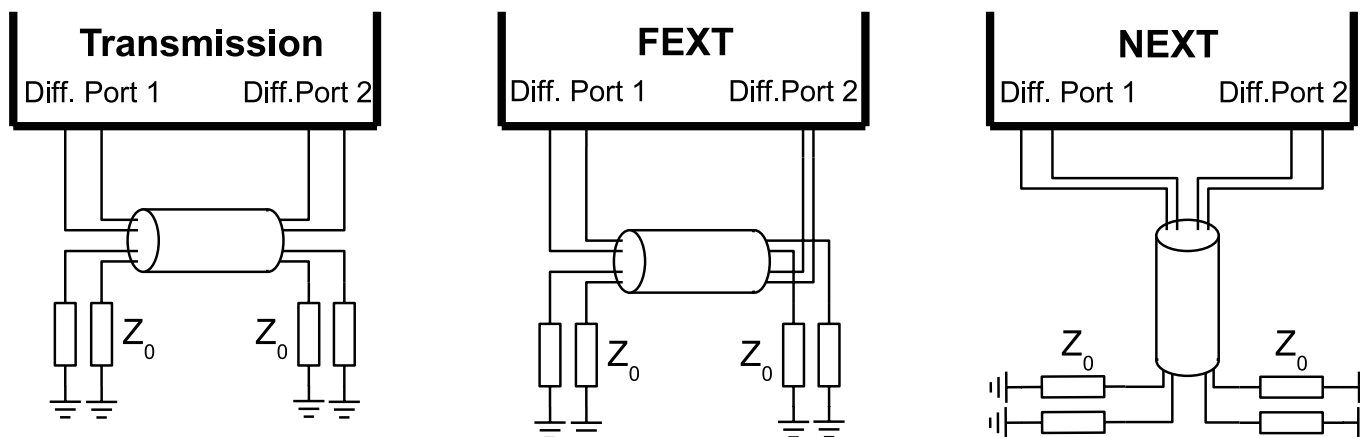

Figure 4: Setup for reflection/transmission measurements on the same pair and Crosstalk measurements to the neighboring pair

The most important measurement variables in terms of the scattering parameter representation for characterization of these properties are:

- Insertion loss ( $S_{DD21}$ )
- Return loss ( $S_{DD11}$ )
- Crosstalk ( $S_{DD21}$  NEXT and  $S_{DD21}$  FEXT)
- Mode conversion ( $S_{CD11}/S_{CD21}$ )
- Screening and coupling attenuation

<sup>3</sup>FEXT: far end crosstalk

<sup>4</sup>NEXT: near end crosstalk

## Design and Evaluation of a Data Link

The eye diagram as the measure of quality for the transmission path

Measurement of eye patterns is performed by a setup in which a source generates a known bit stream that is fed into a transmission channel. Once the signal has passed the channel, the eye, i.e. the pattern of the bit stream, is displayed and rated on the high-speed sampling oscilloscope. Hereby, the received data stream is segmented into individual bit intervals and superimposed. Refer to Figure 5, which shows the key parameters, which significantly affect the quality of the received eye, the eye height and the eye width. The determination occurs within an unit interval. For laboratory measurements, a data stream is generally approximated by a PRBS<sup>5</sup> signal. This results in various bit sequences, which cause different rising and falling edges after passing through the cable. A "1010" sequence exhibits a different behavior of the cable than a sequence of zeros followed by a change to a "1" due to the low-pass characteristic of the cable.

With the help of eye diagrams signal characteristics of transmission channels are already evaluated in the design development phase. In this way, you ensure that not just the RosenbergerHSD<sup>®</sup> system itself, but also that the entire channel including the cable has excellent electrical transmission properties and meets the highest industrial demands.

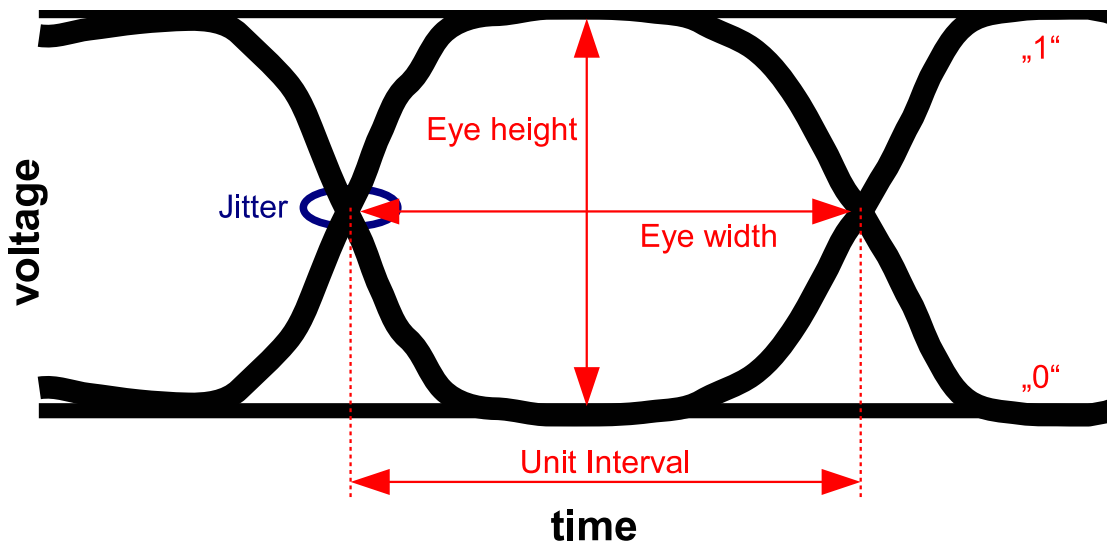

Figure 5: Measurement variables of the eye diagram

<sup>5</sup>PRBS: pseudo random bit sequence

System simulations – The modern method of link evaluation

In the workflow of a system simulation, various software tools are used in combination at Rosenberger, which in total enable the transition from frequency domain (measured/simulated S-parameters) to the simulation of a complete transmission channel in the time domain (eye pattern diagram).

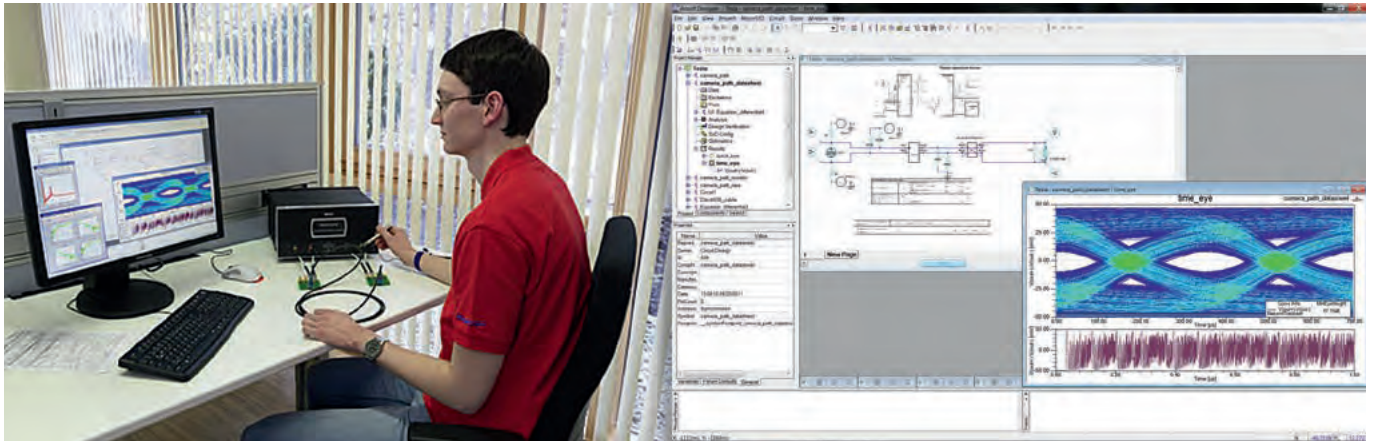

Figure 6: System simulation

The electrical properties of a cable measured with vector network analyzers (VNA) and stored as scattering parameters serve as the basis for the system simulation. In addition to the definition of a source and a sink, and thus the definition of the data stream to be transferred, an arbitrary number of measured cables can be connected and the eye pattern can be generated within minutes without physical measurement of the entire assembly.

The simulation setup has been verified based on several physical measurements. As shown in Figure 7, the simulation has a very good correlation with the measurement.

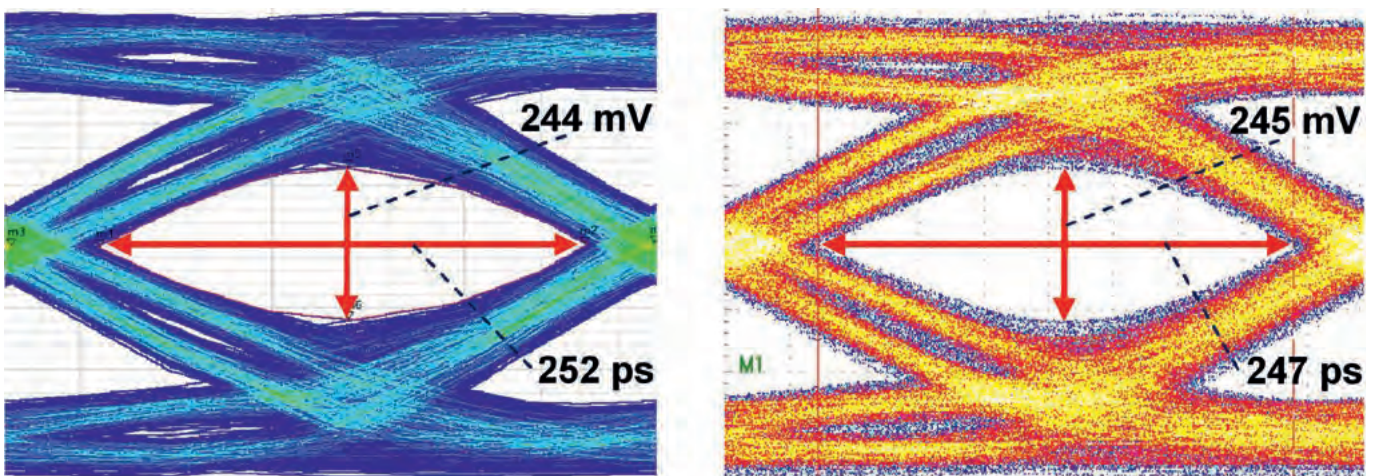

Figure 7: Simulation (left) and measurement (right) of eye pattern diagrams

### Bit rate vs. symbol rate

When transmitting data via a channel, a difference must be drawn between the bit rate and symbol rate. On the one hand, the bit rate describes the throughput of data through the channel per second. On the other hand, the symbol rate describes how this bit rate is achieved by an encoding scheme on signal level. Only with a non-modulated signal in the base band (or NRZ<sup>6</sup>) does the symbol rate correspond to the bit rate. By encoding the symbol rate can be reduced at a constant bit rate. As well reduced are the requirements for the transmission channel regarding the spectral bandwidth. With a pure pulse amplitude modulation PAM (without an additional phase modulation), the fundamental wave is always half the symbol rate, as exactly two symbols fit in a period.

This should be made clearer using the 1000BASE-T Ethernet transmission standard as an example. Four channels are used simultaneously to achieve a bit rate of 1000 Mbps, which is 250 Mbps per channel. The encoding procedure used is PAM5, i.e. an amplitude modulation with the five levels, namely -1, -0.5, 0, 0.5, 1 is applied. Behind four of five symbols (except "0") you will find 2 data bits. This calculates to a symbol rate of 125 Mbaud (125 M symbols/s\*2 bit/symbol = 250 Mbps). A fundamental wave of 62.5 MHz results from the symbol rate.

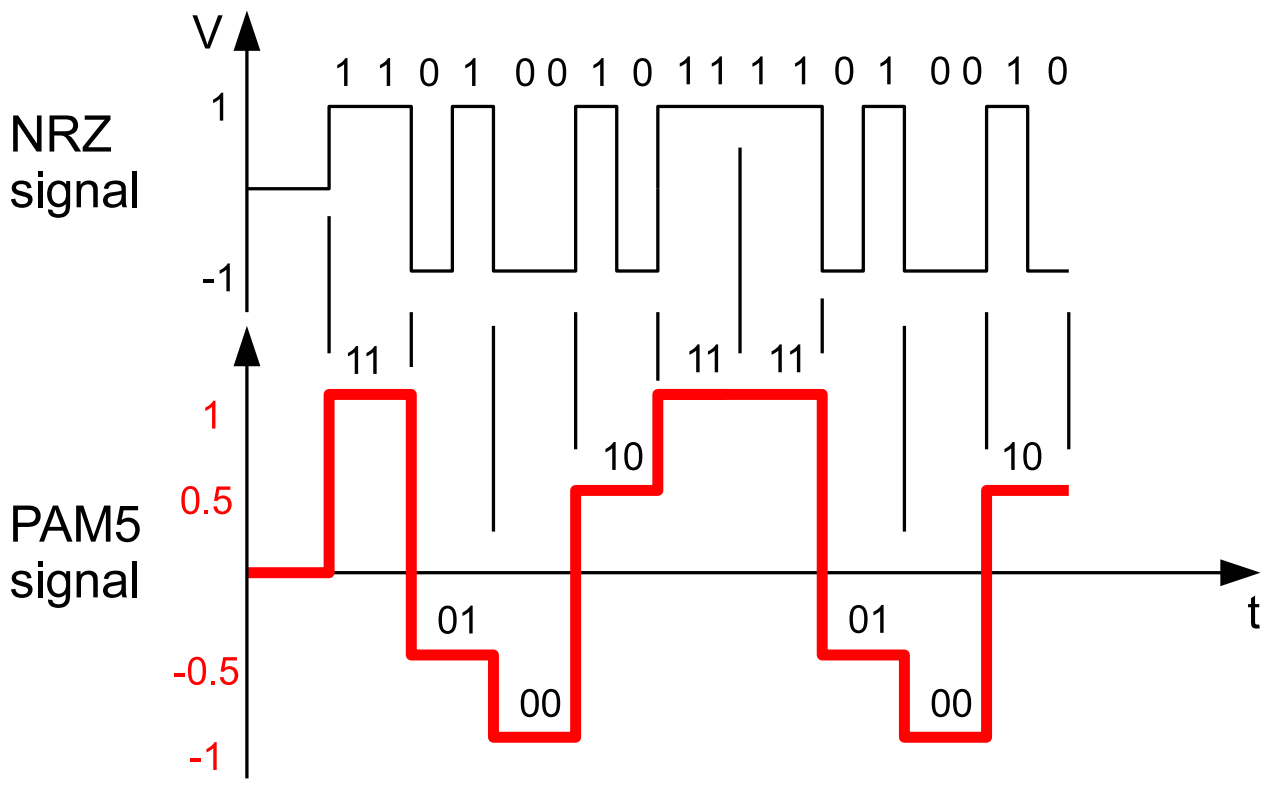

Figure 8: Encoding scheme of a PAM5 signal

<sup>6</sup>NRZ: Non Return to Zero – simplest form of coding a binary signal with 2 inverted voltage levels

## Spectrum of the data stream

In order to highlight the benefits of an encoding of the data stream, a look at the spectrum of various data signals should help. For this, a pseudo-random bit stream (PRBS) with a length of 15 bits was generated and this was encoded as shown in Figure 8 on the one hand to a NRZ and on the other to a PAM5.

In Figure 9, the envelope of the amplitude spectrum is shown over the frequency normalized to the bit rate in Hz ( $f/f_{\text{bit}}$ ). The envelope of a NRZ signal always features a  $(\sin(x)/x)$  progression in the frequency range. In comparison, the spectrum of a PAM5 is compressed and the first zero in the spectrum occurs at half the frequency due to the halving of the symbol rate.

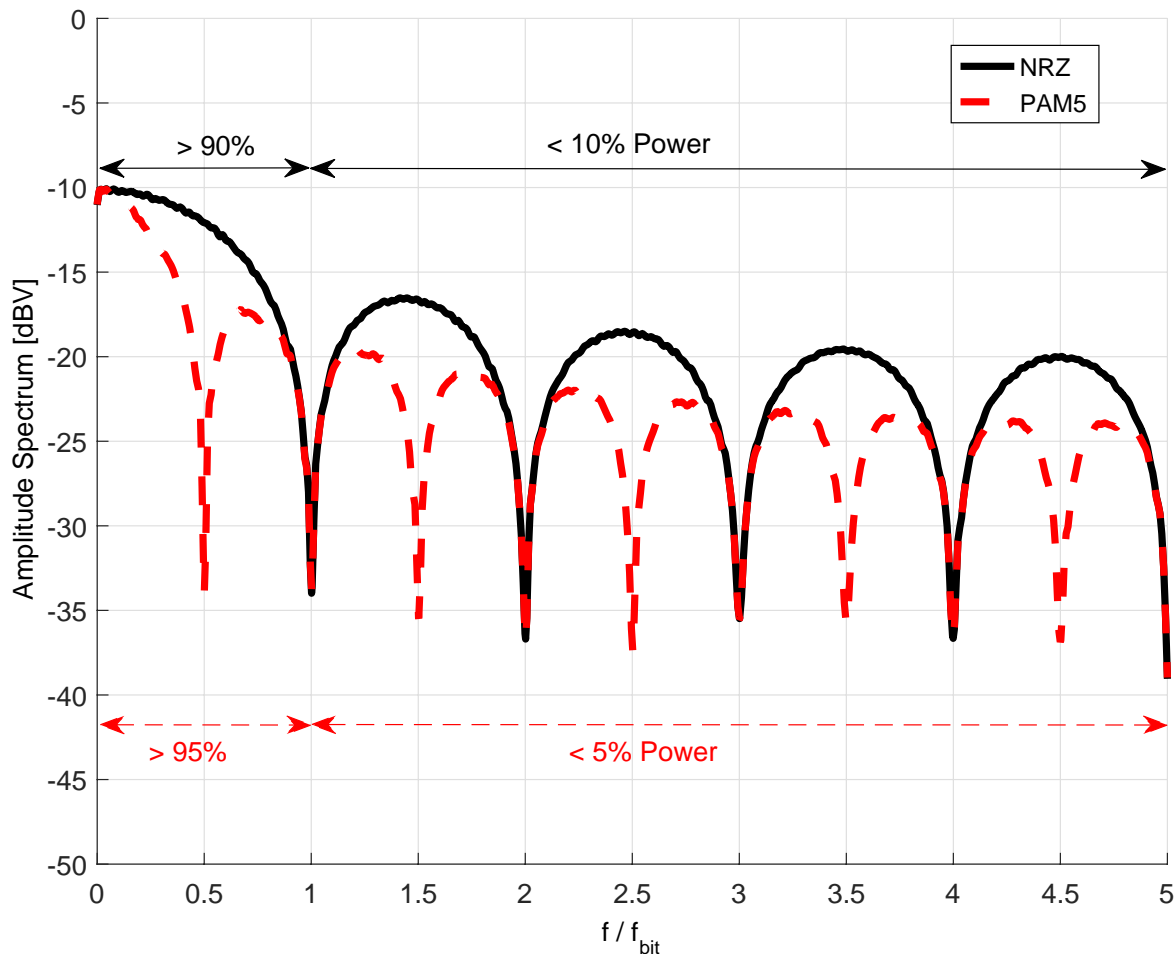

Figure 9: The envelope of the spectral power density of two encoding schemes (NRZ vs. PAM5)

The observation of the spectral distribution of the signal power indicates that with NRZ encoding min. 90 % of the overall energy of the data sequence can be found in the main lobe ( $0 < f/f_{\text{bit}} < 1$ ). Accordingly, all side lobes ( $f/f_{\text{bit}} > 1$ ) only contain max. 10 % of the signal power in total.

This leads to the assumption that all frequency components with large powers (from DC up to the first zero at the symbol rate) have a large influence on the form of the eye pattern diagram and thus on the quality of the transmission. In contrast the transmission of the spectral content of the side lobes should have a significantly lower influence. Whether this assertion can be proven is examined in detail in the following sections.

## Required bandwidth of the transmission channel

A lower fundamental wave is for the good of the transmission, as a cable has a low-pass filter characteristic and thus lower frequencies are less attenuated than higher frequencies. This results in a time signal with flatter edges and an eye which is slightly less open the longer a cable gets. An estimation of the bandwidth required for a distinct symbol rate has been determined in accordance with a simulation setup, as shown in Figure 10. The setup forms a simple transmission system, where a PRBS source is connected via an "ideal cable"<sup>7</sup> and a 3rd order Bessel-Thomson low-pass filter, because of its constant group delay in the passband, with a signal sink. The low-pass filter with variable cut-off frequency  $f_0$  provides an adjustable bandwidth limitation of the transmission channel.

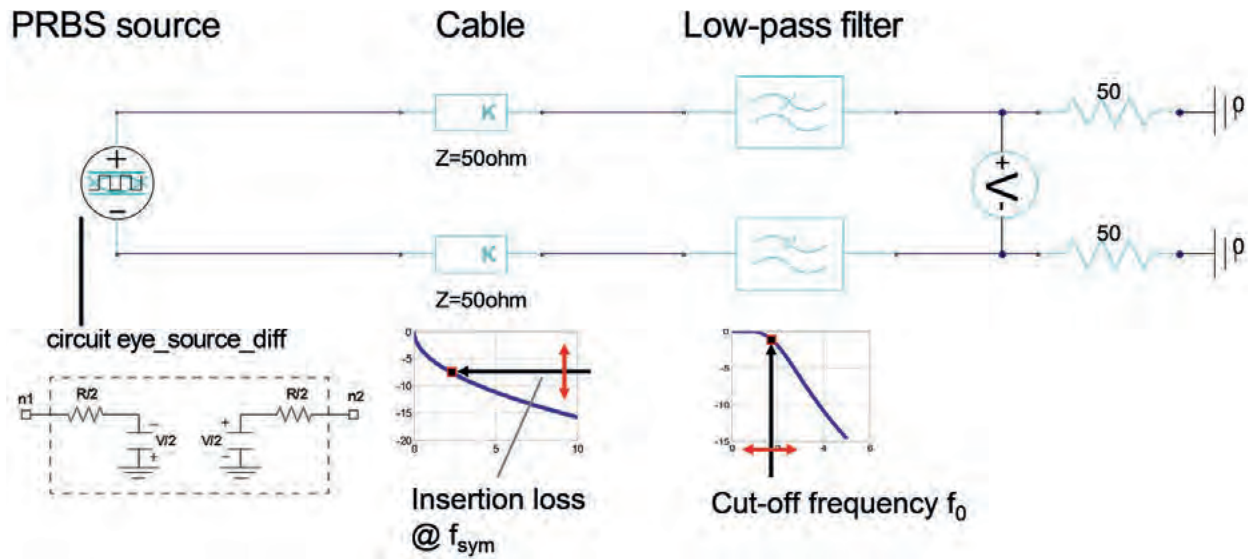

Figure 10: Simulation setup for the estimation of the required bandwidth of a data signal

Figure 11 shows the vertical eye opening in percent over the quotient of the low-pass filter's cut off frequency  $f_0$  and the frequency  $f_{sym}$  corresponding to the symbol rate in Hz. The black curve shows the eye opening with pure limitation of the bandwidth by the low-pass filter. With the blue, red and green curves, an additional cable attenuation of 5, 10 or 15 dB at  $f_{sym}$  was added, i.e. for example for 1 Gbaud and insertion loss of 5, 10 or 15 dB at  $f_{sym} = 1$  GHz.

As depicted, the maximal eye opening for this kind of bandwidth limitation is already achieved at a cut-off frequency of approx. three-fourths of the symbol rate in Hz ( $f_0/f_{sym} = 0.75$ ). Physically this means that the fundamental wave of a NRZ data signal (bit sequence 101010...) at  $f_{bit}/2$  must be transmitted. The transmission of harmonics of the fundamental wave plays an inferior role. With high-level encoding, as with PAM5, this means a reduction of the transmission properties of the channel even to  $0.375 \cdot f_{bit}$ . The reduction in the eye opening for  $f_0/f_{sym} < 1$  is significantly determined by the order of the low-pass filter. A higher filter order would ensure a higher bandwidth limitation and thus for a stronger reduction of the eye opening for cut-off frequencies  $f_0 < f_{sym}$ . Thus, by applying a setup as shown in Figure 10, the assumption is confirmed that primarily the main lobe of the spectrum is responsible for the data transmission and thus the opening of the eye.

<sup>7</sup>This "ideal cable" emulates the response of a decoupled differential pair with variable attenuation characteristic. The attenuation value at the frequency  $f_{sym}$  corresponding to the symbol rate in Hz can be explicitly given.

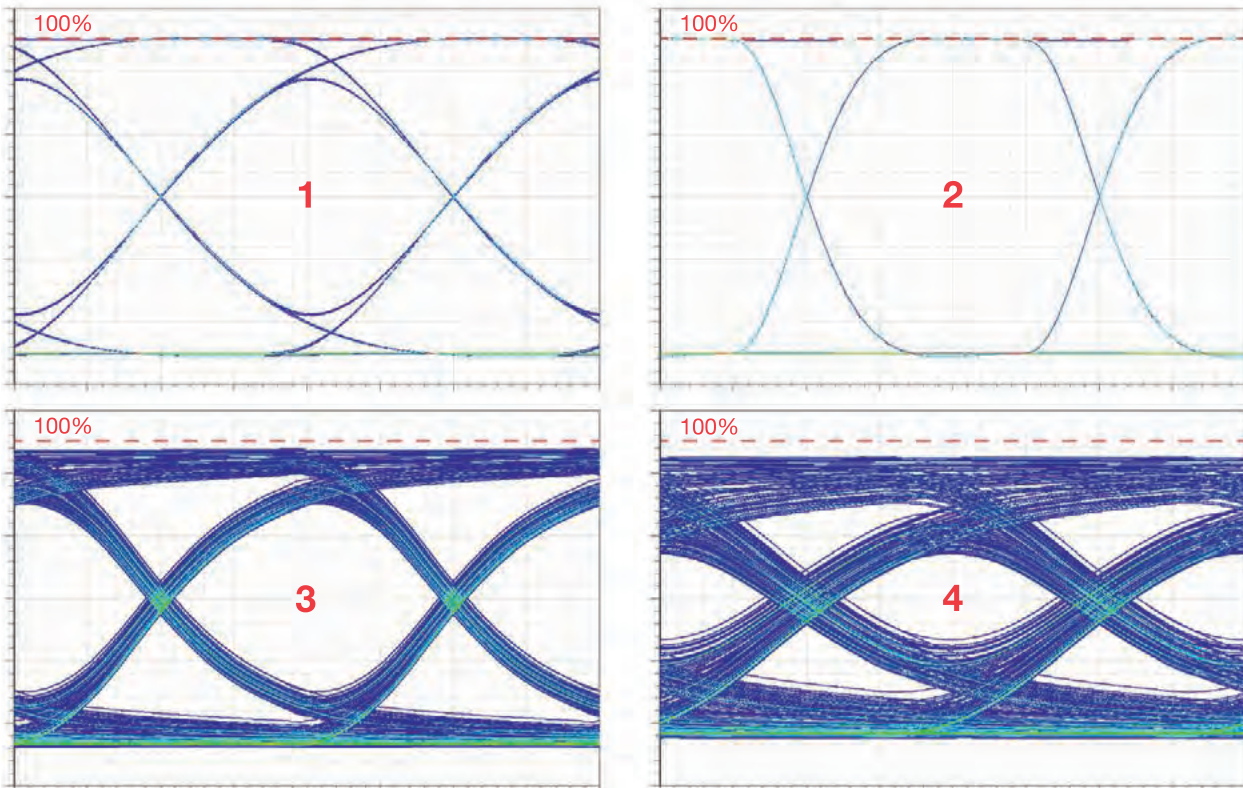
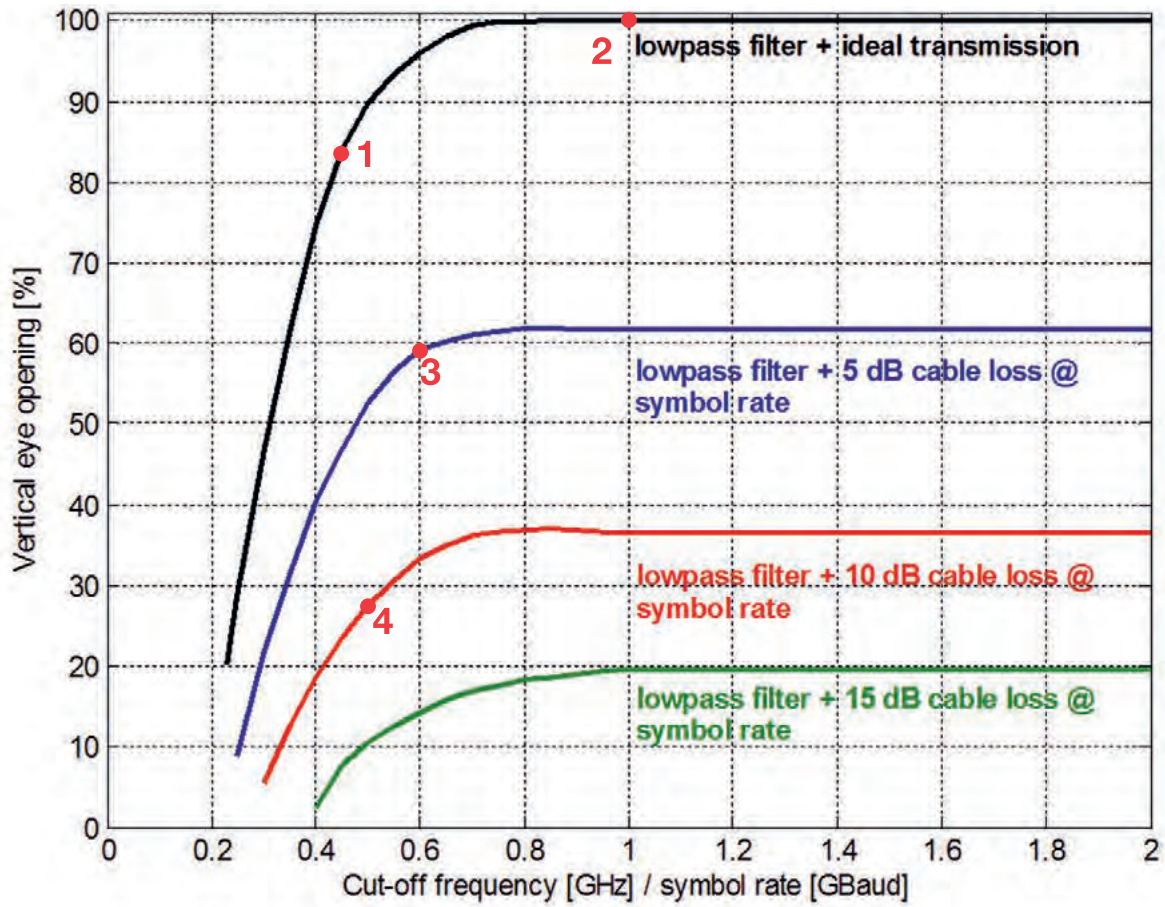

Figure 11: Eye opening at a limited channel bandwidth

## Maximum link length

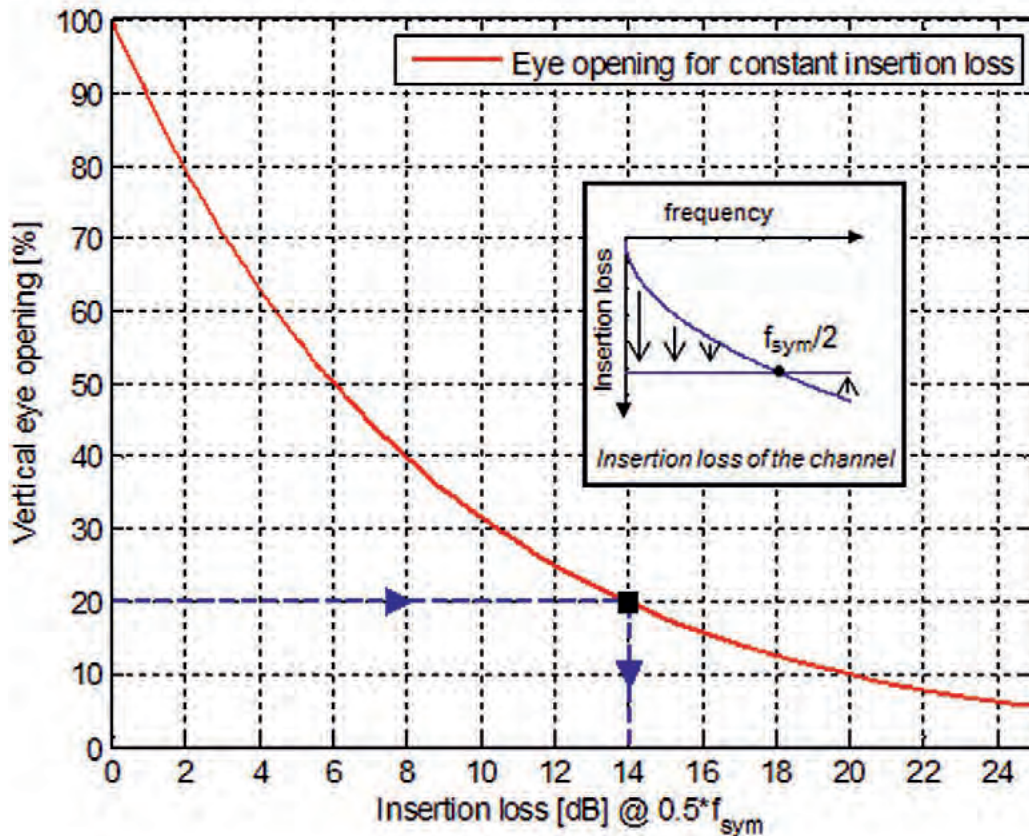

Figure 12: Eye opening via the insertion loss

For the case that there is no obligatory specification from the chip manufacturer regarding a certain transmission standard, Figure 12 helps estimating the maximum possible link length. Therefore, the following steps are necessary:

- With the cable datasheet: Determination of the attenuation budget of the link (new/aged) consisting of the influence of the cable, the connector/inlines and the PCB.
- With the chip datasheet: Determination of the voltage swing (max./typ./worst-case) between the transmitter amplitude and the height of the decision threshold at the receiver.

As a calculation example, the worst-case estimate for a fictive LVDS system (NRZ encoding) with 3 Gbps is used, with an amplitude of at least 500 mV on the output of the transmitter and a maximum decision threshold on the receiver input of 100 mV. This results in a required vertical eye opening of 20 %. This equals to a maximum permissible attenuation of 14 dB. Subtracting 1 dB insertion loss for the PCBs leaves an attenuation budget of 13 dB for the cable. According to the data sheet, the cable has an attenuation at  $0.5 \cdot f_{\text{sym}} = 1.5 \text{ GHz}$  of 1.3 dB/m (in new condition). Accordingly, the maximum link length is calculated to be 10 m. If it is also known to which extent the insertion loss of the cable material increases over aging as determined by environmental testing, the maximum link length can be estimated even for the aged case using Figure 12.

These estimations are only valid under the assumption that through equalization the frequency response of the channel can be completely flattened, i.e. there is constant attenuation over all frequencies. This condition, which is state-of-the-art, is sketched in Figure 12. Furthermore, this type of equalization is described in more detail in one of the following chapters. If the low-pass characteristic of the channel is not compensated, it may occur that the signal at the receiver chip is too much distorted because of ISI jitter.

### Crosstalk (FEXT/NEXT)

By combining the individual scattering parameters of Reflexion/Transmission, FEXT and NEXT measurements (compare to Figure 4), overall models of measured star-quad cables (here for example a LEONI Dacar® 535-2) can be achieved. Such a scattering parameter model is the basis for tests for the examination of the signal quality with crosstalk (FEXT/NEXT) according to Figure 13.

There a RosenbergerHSD®-Link with a PRBS signal (NRZ encoded) at 3 Gbps over 1 meter is shown, which is operated initially without noise on the second pair of wires. If a second data signal which operates as an interference (noise) signal for the first pair is put into operation, the favorable crosstalk behavior of the star-quad becomes evident. It is characterized by very minimal crosstalk on the near as well as the far end. This enables the transmission of a second independent data signal with 3 Gbps on the second pair without subjecting the eye pattern diagram to visible influences (Figure 13, above). Only the increase of the signal amplitude of the interference source by a factor of 10 (below) leads to a visible influence on the eye opening diagram on the first pair.

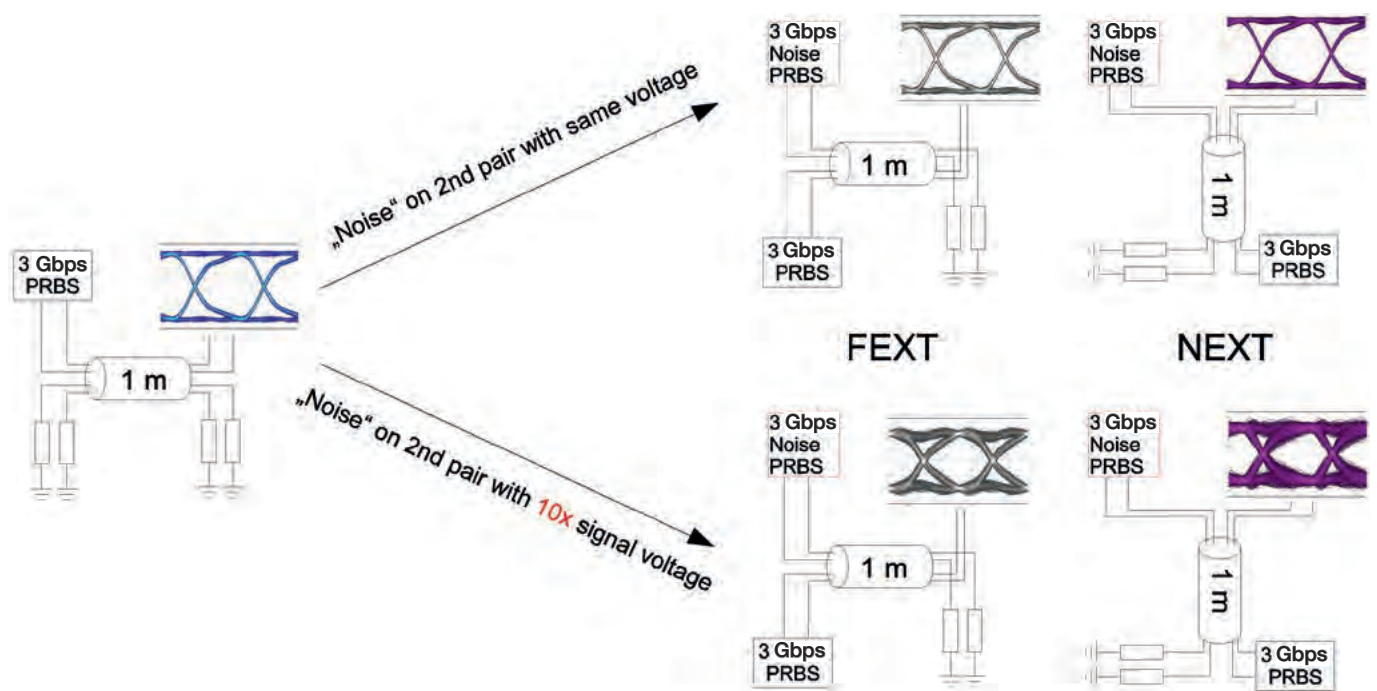

Figure 13: Influence of the eye opening diagram by crosstalk (FEXT/NEXT) of a separate data signal ("Noise") over 1 m cable length (measured) on an LVDS system @ 3 Gbps

### TDR<sup>8</sup>-measurement for determination of the impedance of the connector and the cable

With the aid of the TDR measurement method, the impedance level along a link can be represented over times and locations respectively. To avoid signal distortion due to multiple reflections between discontinuities, particularly in the area of the junction from the connector to the cable, the lowest possible divergence from the reference impedance of 100 Ω is to be achieved.

For evaluation of the typical impedance curve of the RosenbergerHSD<sup>®</sup> system, the rise time has been limited to 120 ps on a TDR oscilloscope. Using the relationship

$$\text{"Rise time x Band width = 0.35"}$$

it can be calculated to an approximate measurement bandwidth of 3 GHz. The measurement result is shown in Figure 14. The plot shows the impedance when running through an adaptor board and a section of a 10 m long LEONI Dacar<sup>®</sup> 535. Even with the shortest rise time of 120 ps, the divergences from the rated impedance of 100 Ω remains under 10 %. In the following section, it is evaluated if several discontinuities of this type have an effect on the transmission.

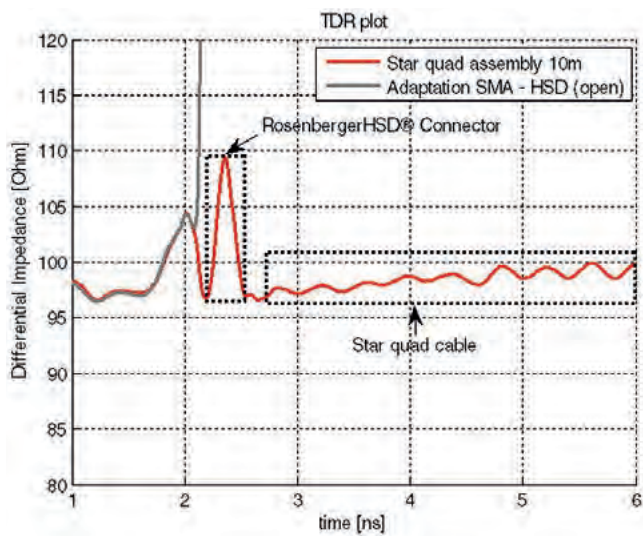

Figure 14: TDR plot of a star quad-cable

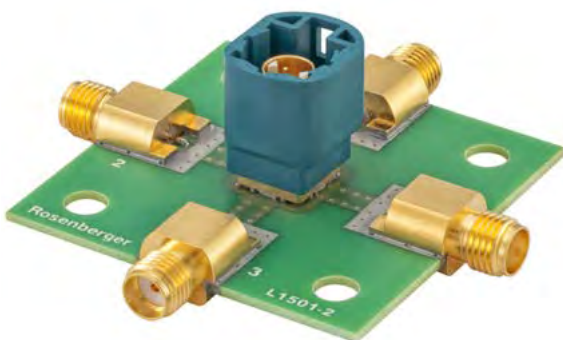

Figure 15: Adaption of SMA to RosenbergerHSD<sup>®</sup>, which is used for VNA and TDR measurements

<sup>8</sup>Time Domain Reflectometry – a procedure for determination of impedance curves over time due to reflections and running times in the test object

### Influence of the transmission behavior through several inlines

In the following test, a 10 m cable with a 10 m link cut into pieces, consisting of a total of five cable segments each of 2 m length are compared. The term "inline" here represents the additional couplings in the link, i.e. the link of five cable sections accordingly has four inlines.

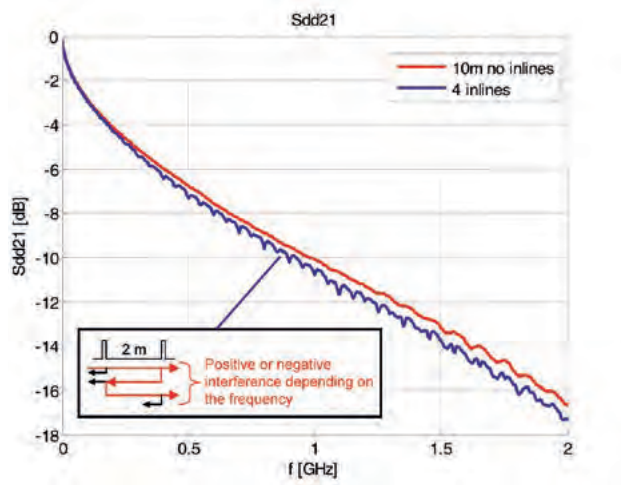

Figure 16: Insertion losses when using Inline

If the differential transmission is observed (Figure 16), a slight ripple is recognizable over frequency, which results from the reflections at these inline connectors. Due to the impact of multiple reflexions among the discontinuities, the transmission attenuation is slightly larger compared to the case without any inline. Additional eye pattern diagrams have been created in order to examine the influence on the transmission more closely. In Figure 17 it is clearly shown that with a data transmission of 3 Gbps over a link length of 10 m with four inlines that the eye pattern diagram is only affected insignificantly.

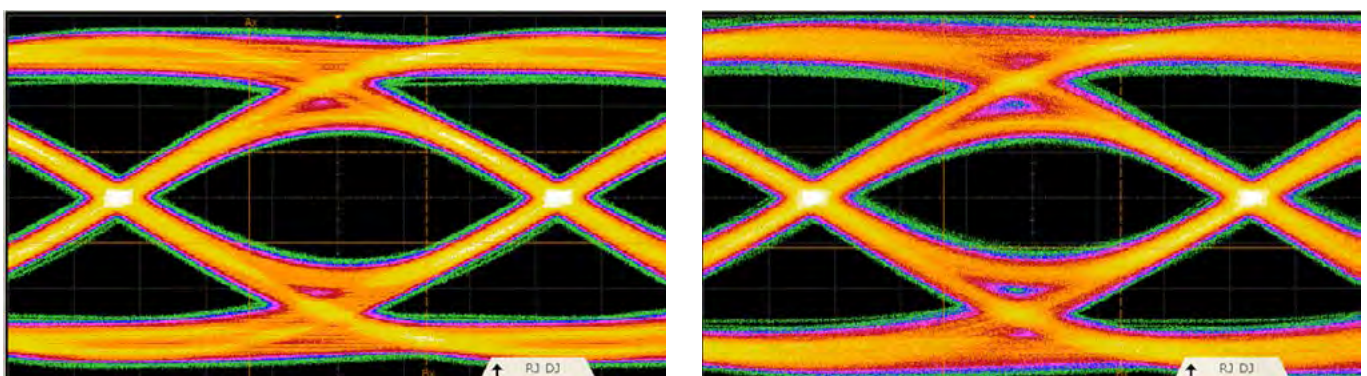

Figure 17: Eye diagram when transmitting 3 Gbps over 10 m – left: no inlines; right: 4 inlines (i.e. 5 x 2 m)

### Linearization of the frequency response

In this section, it is examined how the closing of the eye diagram can be counteracted. A measure of this kind can be undertaken passively (without amplification) as well as actively (with amplification). The objective in both cases is to compensate the rise in cable attenuation at high frequencies (low-pass response) with the assistance of an equalizer (with high-pass response). This is typically achieved by preemphasis and deemphasis implemented directly within the transmit and receive chipset.

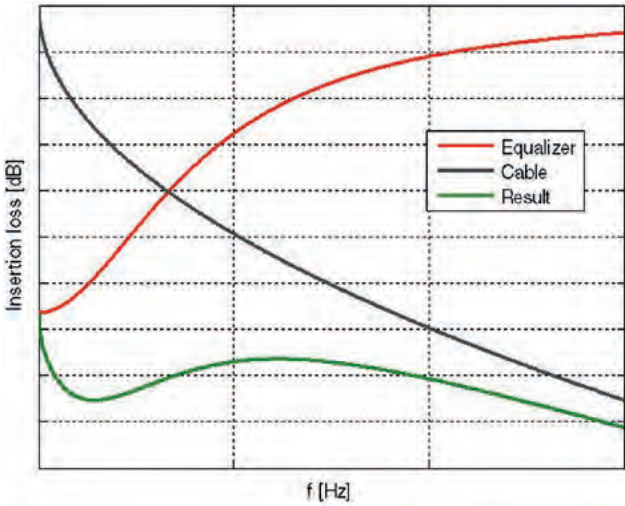

Figure 18: Insertion losses when a passive equalizer is used

In Figure 18, the principle shape of the differential insertion loss  $S_{DD21}$  is represented over frequency separately for a cable (gray) as well as for a passive equalizer (red). The green curve indicates the resulting transmission response after running through the cable and equalizer. The smoothing/linearization of the frequency response is clearly depicted. The effects on the eye pattern diagram can be seen in Figure 19. Even though the amplitude is somewhat attenuated, the opening of the eye it is clear to see through the passive linearization. Thus the maximal transmission length of a link can be increased for a certain data rate. Alternatively, an equalizer allows raising the maximum data rate at a fixed link length.

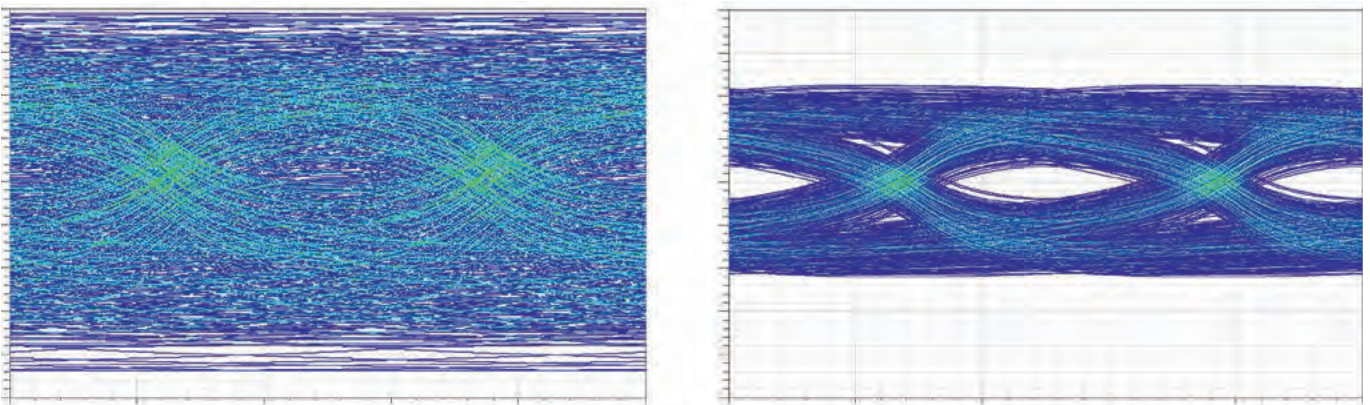

Figure 19: Eye opening with the use of a passive Equalizer (left "without", right "with Equalizer")

Using passive linearization in a test with a transmission rate of 800 Mbps and a cable with approx. 1.25 dB/m @ 1 GHz, the total length of approx. 13 meters could be increased to approx 25 meters. This corresponds to an increase of almost 100 %. Particularly with higher data rates such as e.g. 3 Gbps linearization measures are indispensable. Through active linearization, the maximum possible transmission length can be extended far more.

Propagation delay differences at higher data rates

Propagation delay differences within a differential pair can result due to the differing lengths of both conductors. This difference, also referred to as "intra-pair skew" can be determined with scattering parameter measurements based on increased mode conversion. Length differences become primarily evident at higher data rates, as here delay differences are in the range of the symbol length.



Figure 20: Pair length difference

The length difference causes the conversion from differential mode (DM) to common mode (CM). In Figure 21 you can see that for a frequency of 1.5 GHz 100 mm length difference (black curve), a complete conversion from DM to CM has occurred. A frequency of 1.5 GHz corresponds to a wavelength of 200 mm in air, i.e. 100 mm corresponds exactly to a 180° phase difference and thus the differential signal on the input will become a CM signal by the phase offset and thus the differential voltage on the output is equal to zero. Frequencies above 1.5 GHz may again show a better mode conversion behaviour since the phase shift increases towards 360°. However, this is harmful for data transmission, since the receiver then sees different bits on the two wires at a given time.

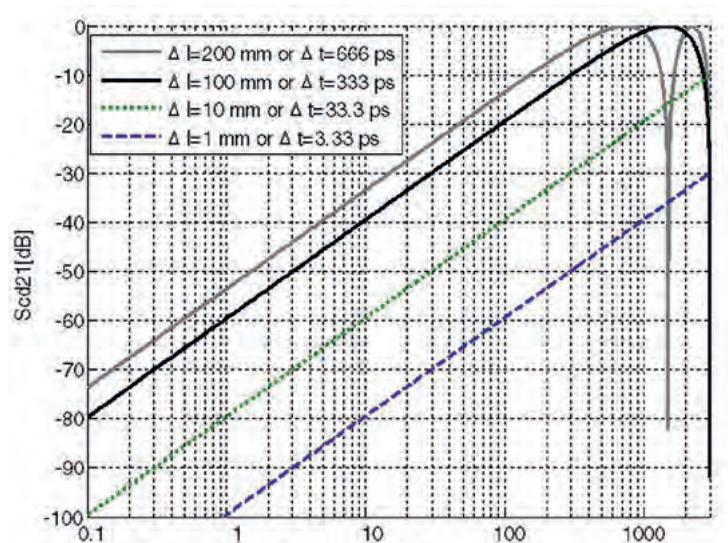

Figure 21: Mode conversion with differing conductor lengths

### Impact of propagation delay differences on the data transmission

If the differential data signal is now observed, a time offset between both conductors leads to closing of the eye and bit errors can result. Figure 22 shows the symbol length (in Unit Interval, abbr. UI) and the time offset through the longer delay on DATA- up to the output. You can see that the phase difference is no longer 180°, the edges no longer change synchronously and thus the maximum differential amplitude can only be achieved when both edge changes have occurred after one another. If the sampling occurs before the second delayed edge has changed completely, there is a reduced or no differential amplitude.

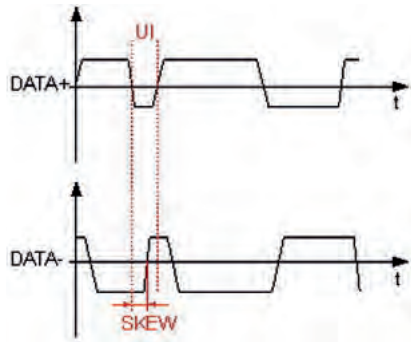

Figure 22: Skew on the differential data signal

The level to which the differential signal and thus the eye height is affected highly depends on the shape of the edge and a general relationship between the propagation delay difference with respect to the symbol duration and the eye opening cannot be derived. Figure 23 shows the simulation configuration with the introduced runtime difference on a conductor and measured scattering parameter set of a cable.

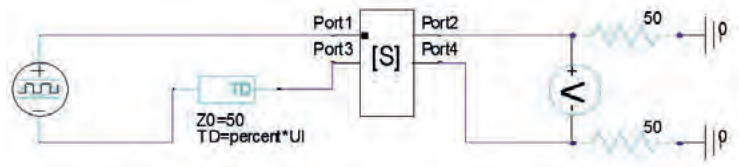

Figure 23: Circuit for simulation of run time differences

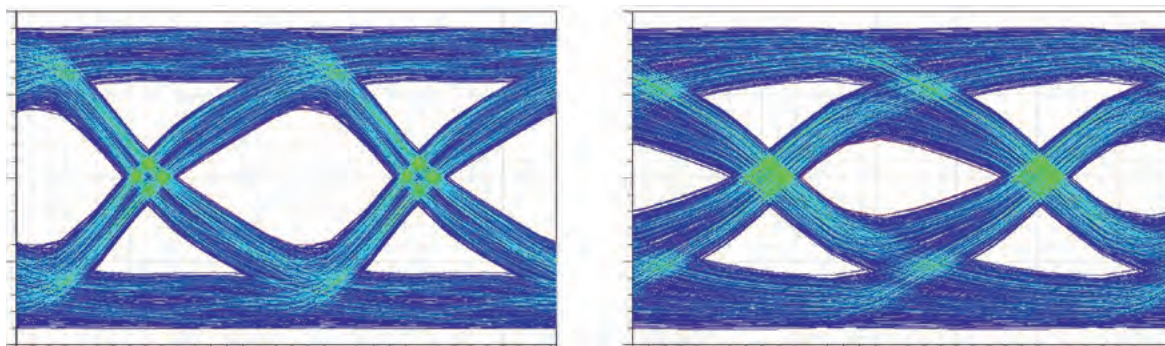

Figure 24: Data quality at 3 Gbps over 5 m without (left) and with 0.5 UI delay difference (right)

As an example, the eye diagram without and with 0.5 UI, i.e. 167 ps, runtime difference, is shown in Figure 24 over a 5 m cable at 3 Gbps. A reduced eye opening can be seen, however, the eye is still open even though the data signal on one conductor is delayed by half the symbol length.

Furthermore, compensation measures are possible that are undertaken in the receiver or the introduced runtime difference is counteracted directly in the transmission channel by compensation of the different lengths.

## EMC Aspects of Differential Signaling

As more and more electronic services are integrated into modern passenger cars, they may be considered as mobile infotainment platforms. Proper EMC-design is a very challenging aspect of the electronics system integration as high amplitude sources of noise have to be placed very close to sensitive broadcast, navigation and communication equipment. The key challenge of all EMC efforts is defined nicely within VDE 0870:

The term EMC describes the ability of an electrical equipment to work sufficiently within its electromagnetic environment without disturbing this environment, which also includes other equipment, in an impermissible way.

This means that every electronic system has to work reliably under worst case exposure to external electromagnetic interferers while self-emissions have to be sufficiently low in order to assure that no other system is impacted.

The susceptibility of the system to electromagnetic noise from an interferer is often measured according to ISO 11452-4 (BCI-test) or ISO 11452-5 (Stripline test). In both cases, the system is subject to a strong interfering signal. A set of test severity levels defines the amplitude of the interferer. The system has to work properly up to the predefined severity levels.

It is widely accepted in the automotive industry to measure emissions from an automotive electronic system according to CISPR 25. As is the case for susceptibility tests, the topology of the system under test (position, length, height above the ground plane) is defined in every detail. This is essential in order to ensure comparability between test results.



## EMC test standards at component level

Rosenberger put a significant amount of work in the answer to the question, what screening requirements are to be specified for each of the components in the link.

Figure 25 shows the situation on an abstract level: The entire system is operated transmitting and receiving data (left box). A certain amount of the signal is received in the test setup (right box). Following the approaches of communications engineering, we may define a transfer function that explains, to what extent the transmitted signal couples to the adjacent receiving device (middle box).

This transfer function is defined by the topology of the test setup together with the screening (coupling) attenuation of the individual components of the link. If the power spectrum of the datastream, the network topology and the frequency response of the link are known, the potential noise level may be estimated or – if the spectral power distribution and the permissible noise level are defined – requirements for the screening attenuation of components may be derived.

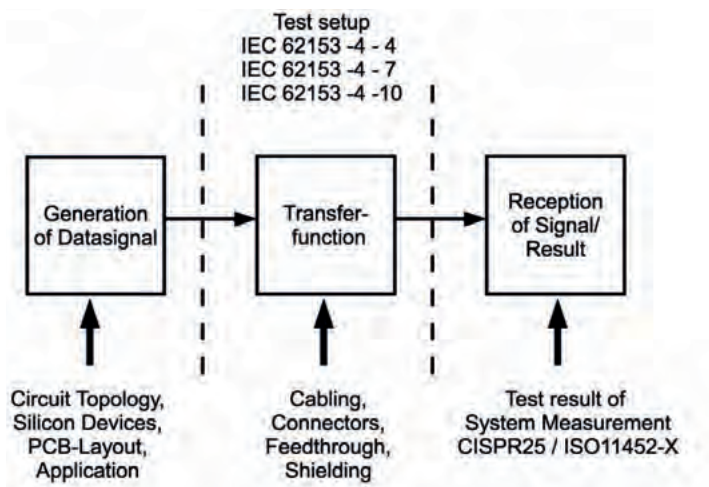

Figure 25: Link between transmitted datasignal and received EMC levels

If we take a closer look at the topology of the datalink, we will find a situation as shown in Figure 26. Components involved are feedthroughs (blue), cables (darkgray) and inlines (lightgray). We have learned that reasonable estimations for the maximum values of the transfer function may be deduced. Requirements for the screening (coupling) performance of individual components may then be defined. Rosenberger contributes to IEC standardization, where a set of test procedures have been specified that define how to measure the transfer impedance and screening (coupling) attenuation of feedthroughs, cables and inlines. The test specifications are named in Figure 26. If components with proven EMV performance are applied in the system integration, there is very high confidence that the system will meet the requirements in the first design cycle. As well, these test setups are a very powerful tool to investigate the screening attenuation of unknown products over frequency and thus to be able to judge their applicability in a given project.

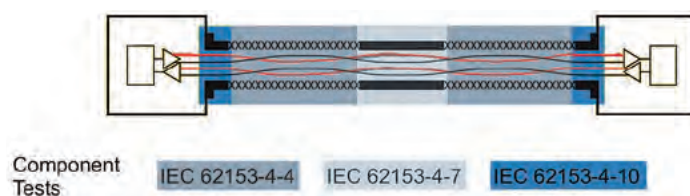

Figure 26: Schematic breakup of the screen into individual components  
Feedthroughs: blue, Cabling: darkgray, Inlines: lightgray

Screening of cables and feedthroughs

Figure 27 presents the screening attenuation for different cables with RosenbergerHSD® connectors. The three variants involved are semi-shielded (red) and fully-shielded (blue) cables.

Figure 28 shows the screening effectiveness of different housing feedthroughs for the HSD system.

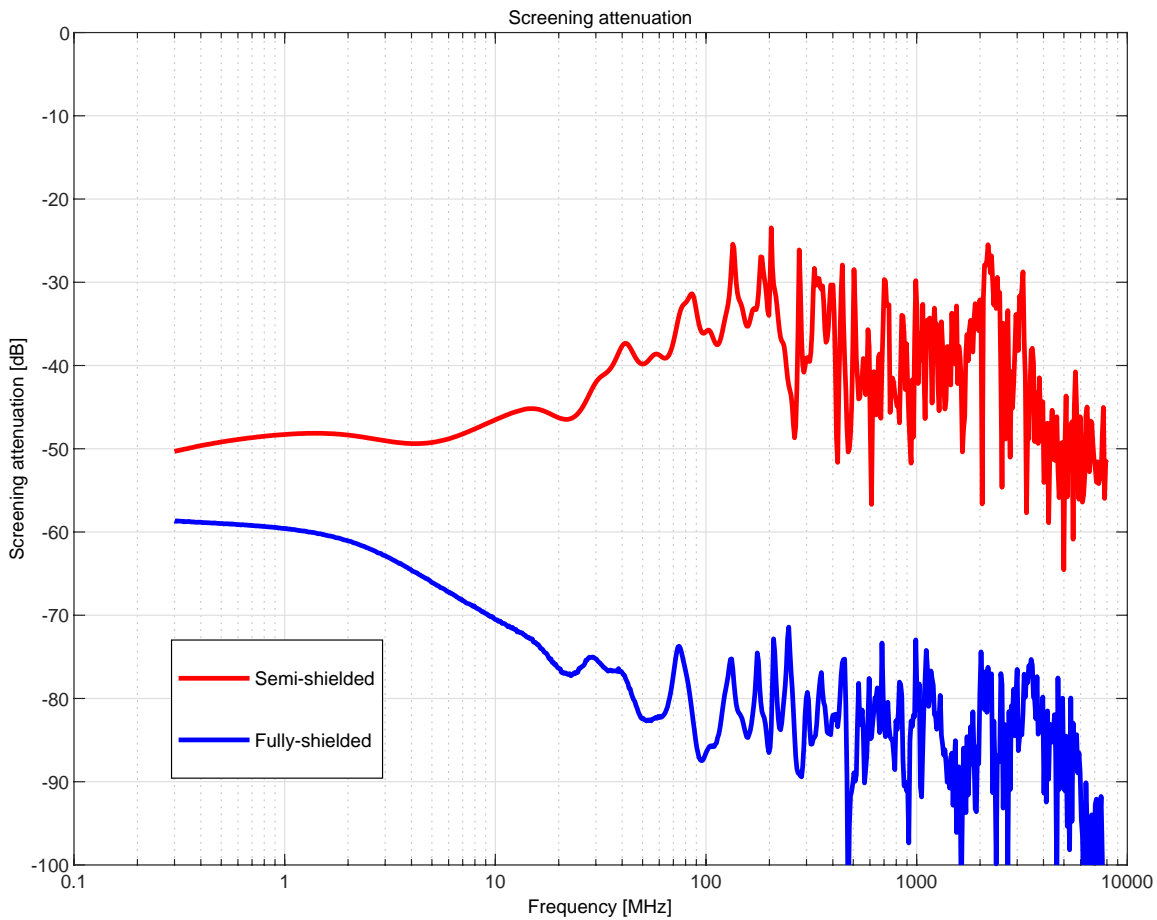

Figure 27: Screening attenuation

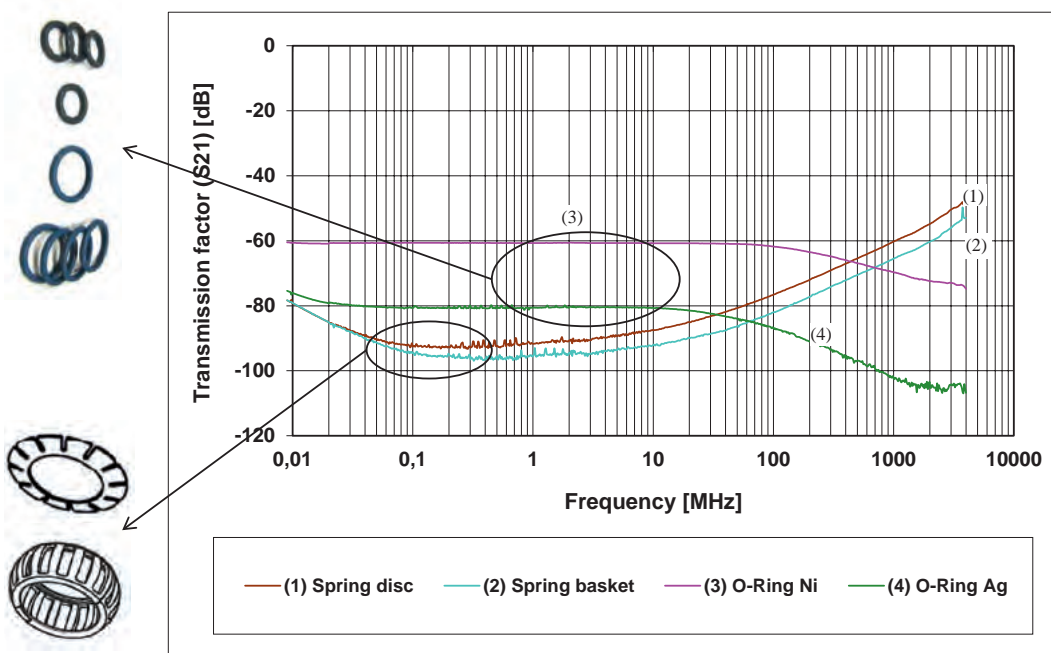

Figure 28: Shielding of feedthroughs

## Glossary

Common mode: Describes the part of two signals that has same phase and amplitude  $[(U1+U2)/2]$ .

Differential mode: Describes the difference of two signals  $[U1-U2]$ . For maximum differential signal the two signals have to be shifted by  $180^\circ$ .

FEXT: Far End Crosstalk, describes the part of an input signal that couples into an adjacent wire or diff. pair at the far end, i.e. from one end of the cable to the other.

NEXT: Near End Crosstalk, describes the part of an input signal that couples into an adjacent wire or diff. pair at the near end, i.e. at the same end of the cable.

TDR: Time Domain Reflectometry, a time domain measurement technique that uses a voltage pulse in order to show impedance over time or spatially resolved.





# Rosenberger No.

59W010-000	45
59W011-000	45
99K11D-1D5A5-y	35
99K15A-1D5A5-y	37
99K15B-1D5A5-y	37
99K20K-1D5A5-y	35
99K2LK-1D5A5-Y	35
99K2LL-1D5A5-y	36
99K2RK-1D5A5-Y	35
99K2UK-1D5A5-Y	35
99S10L-40MA5-y	36
99S10R-40MA5-y	34
99S15A-1D5A5-y	37
99S16D-1D5A5-y	35
99S219-40MA5-y	37
99S21L-40MA5-y	36
99S23F-40MA5-y	34
D2K10A-1AQA5-y	41
D2K10A-1D9A5-y	41
D2K14A-1D9A5-y	43
D2K20A-1D9A5-y	41
D2K25A-1D9A5-y	43
D2S10A-1AQA5-y	41
D2S10A-1D9A5-y	41
D2S14A-1D9A5-y	43
D4K101-1D5/40Z	45
D4K10A-1D5A5-y	30
D4K10A-K00A5-Z	44
D4K10C-1D5A5-y	31
D4K10D-1D5A5-y	31
D4K14A-1D5A5-y	33
D4K14C-1D5A5-y	33
D4K1UA-1D5A5-y	30
D4K20B-1D5A5-y	31
D4K20C-1D5A5-y	31
D4K20E-1D5A5-y	30
D4K25A-1D5A5-y	33
D4K25L-1D5A5-y	33
D4K25R-1D5A5-y	33
D4K2LE-1D5A5-y	30
D4K2RE-1D5A5-y	30
D4K2UE-1D5A5-y	30
D4S10A-1D5A5-y	30
D4S10A-400L5-y	26
D4S10E-40MA5-y	27
D4S10P-40MA5-y	28
D4S10V-40MA5-y	29
D4S12H-40MA5-y	27
D4S14A-1D5A5-y	33
D4S14D-40MA5-y	27, 33
D4S1EQ-S01A5-yy	44
D4S20G-400A5-y	26
D4S20P-400A5-y	26
D4S20W-40MA5-y	28
D4S20Y-400A5-y	26
D4S20Y-40MA5-y	27
D4S21J-40MA5-y	29
D4S23L-40MA5-y	27
D4S23M-40MA5-y	27
D4S24D-400A5-y	26, 33
D4S2UG-400A5-y	26
D4S2UL-40MA5-y	27
D4S2UQ-40MA5-Y	27
D4S2UY-400A5-y	26

D4S2UY-40MA5-y	27
D4W001-000	45
D4W002-000	45
D4W003-000	45
D4W004-000	45
D4W006-000	45
D4W006-SET	45
D4W007-000	45
D4W008-000	45
D4W0A3-1D5	45
D4W0A6-1D5	45
D4W0A6-SET	45
D4W0A8-1D5	45
D4W0B6-1D5	45
LAF-101-xxxx-y-y	48
LAF-102-xxxx-y-y	48
LAF-103-xxxx-y-y	48
LAF-104-xxxx-y-y	48
LAF-201-xxxx-y-y	50
LAF-202-xxxx-y-y	50
LAF-203-xxxx-y-y	50
LAF-204-xxxx-y-y	50
LAF-205-xxxx-y-y	51
LAF-206-xxxx-y-y	51
LAF-207-xxxx-y-y	51
LAF-208-xxxx-y-y	51
LAF-209-xxxx-y-y	52
LAF-210-xxxx-y-y	52
LAF-211-xxxx-y-y	52
LAF-212-xxxx-y-y	52
LAF-213-xxxx-y-y	53
LAF-214-xxxx-y-y	53
LAF-215-xxxx-y-y	53
LAF-216-xxxx-y-y	53
LAF-217-xxxx-y-y	54
LAF-218-xxxx-y-y	54
LAF-219-xxxx-y-y	54
LAF-220-xxxx-y-y	54
LAF-221-xxxx-y-y	55
LAF-222-xxxx-y-y	55
LAF-223-xxxx-y-y	55
LAF-224-xxxx-y-y	55
LAF-225-xxxx-y-y	56
LAF-226-xxxx-y-y	56
LAF-227-xxxx-y-y	56
LAF-228-xxxx-y-y	56
LAF-229-xxxx-y-y	57
LAF-230-xxxx-y-y	57
LAF-231-xxxx-y-y	57
LAF-232-xxxx-y-y	57
LD5-101-xxxx-y-y	48
LD5-102-xxxx-y-y	48
LD5-103-xxxx-y-y	48
LD5-104-xxxx-y-y	48
LD5-105-xxxx-y-y	49
LD5-106-xxxx-y-y	49
LD5-107-xxxx-y-y	49
LD5-108-xxxx-y-y	49
LD5-201-xxxx-y-y	50
LD5-202-xxxx-y-y	50
LD5-203-xxxx-y-y	50
LD5-204-xxxx-y-y	50
LD5-205-xxxx-y-y	51
LD5-206-xxxx-y-y	51

LD5-207-xxxx-y-y	51
LD5-208-xxxx-y-y	51
LD5-209-xxxx-y-y	52
LD5-210-xxxx-y-y	52
LD5-211-xxxx-y-y	52
LD5-212-xxxx-y-y	52
LD5-213-xxxx-y-y	53
LD5-214-xxxx-y-y	53
LD5-215-xxxx-y-y	53
LD5-216-xxxx-y-y	53
LD5-217-xxxx-y-y	54
LD5-218-xxxx-y-y	54
LD5-219-xxxx-y-y	54
LD5-220-xxxx-y-y	54
LD5-221-xxxx-y-y	55
LD5-222-xxxx-y-y	55
LD5-223-xxxx-y-y	55
LD5-224-xxxx-y-y	55
LD5-225-xxxx-y-y	56
LD5-226-xxxx-y-y	56
LD5-227-xxxx-y-y	56
LD5-228-xxxx-y-y	56
LD5-229-xxxx-y-y	57
LD5-230-xxxx-y-y	57
LD5-231-xxxx-y-y	57
LD5-232-xxxx-y-y	57
LD9-101-xxxx-y-y	48
LD9-102-xxxx-y-y	48
LD9-103-xxxx-y-y	48
LD9-104-xxxx-y-y	48
LD9-105-xxxx-y-y	49
LD9-106-xxxx-y-y	49
LD9-107-xxxx-y-y	49
LD9-108-xxxx-y-y	49
LD9-201-xxxx-y-y	50
LD9-202-xxxx-y-y	50
LD9-203-xxxx-y-y	50
LD9-205-xxxx-y-y	51
LD9-206-xxxx-y-y	51
LD9-209-xxxx-y-y	52
LD9-210-xxxx-y-y	52
LD9-213-xxxx-y-y	53
LD9-214-xxxx-y-y	53
LD9-217-xxxx-y-y	54
LD9-218-xxxx-y-y	54
LD9-221-xxxx-y-y	55
LD9-222-xxxx-y-y	55
PCB-L1501-SB	45



## Website

For more information refer to our website:  
[www.rosenberger.com/hsd](http://www.rosenberger.com/hsd)

## Rosenberger

Rosenberger Hochfrequenztechnik GmbH & Co. KG

Hauptstraße 1 | 83413 Fridolfing

P.O. Box 1260 | 84526 Tittmoning

Germany

Phone +49 8684 18-0

[info@rosenberger.com](mailto:info@rosenberger.com)

[www.rosenberger.com](http://www.rosenberger.com)

Certified by IATF 16949 · DIN EN 9100 · ISO 9001 · ISO 14001

Order No.

pA 170061 · Info205HSDCatEN

2000/2020

Rosenberger® and RosenbergerHSD® are registered trademarks of Rosenberger Hochfrequenztechnik GmbH & Co. KG.  
All rights reserved.

© Rosenberger 2020