

M23 Industrial

Series L & Series S

Robust Circular Power & Signal Connectors - Size 1



Hypertac[®] Hyperboloid Technology

Smiths Interconnect offers an extensive range of superior contact technologies suitable for standard and custom solutions. Hypertac[®] (HYPERboloid conTACT) is the original superior performing hyperboloid contact technology designed for use in all applications and in harsh and demanding environments where high reliability and safety are critical. The inherent electrical and mechanical characteristics of the Hypertac hyperboloid contact ensures unrivalled performance in terms of reliability, number of mating cycles, low contact force and minimal contact resistance. The shape of the contact sleeve is formed by hyperbolically arranged contact wires, which align themselves elastically as contact lines around the pin, providing a number of linear contact paths.

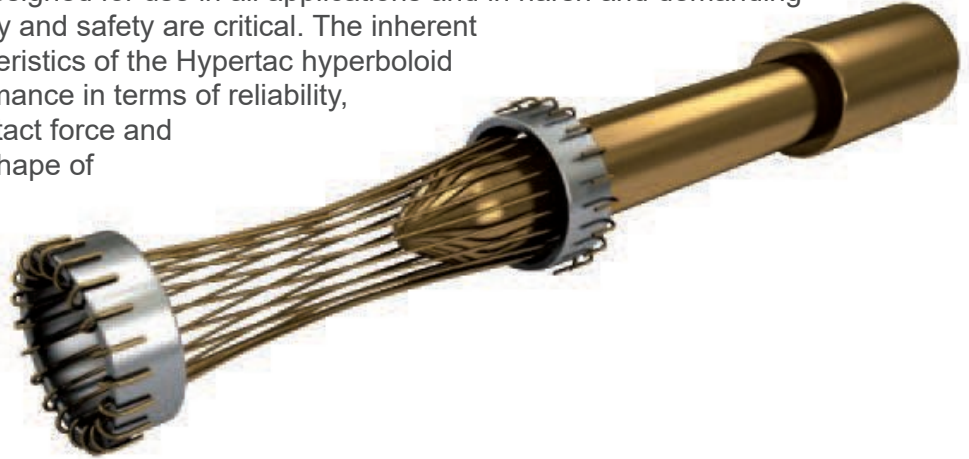

Features	Benefits
<p>Low insertion/extraction forces</p> <p>The angle of the socket wires allows tight control of the pin insertion and extraction forces. The spring wires are smoothly deflected to make line contact with the pin.</p>	<p>High density interconnect systems</p> <p>Significant reductions in size and weight of sub-system designs. No additional hardware is required to overcome mating and un-mating forces.</p>
<p>Long contact life</p> <p>The smooth and light wiping action minimizes wear on the contact surfaces. Contacts perform up to 100,000 insertion/extraction cycles with minimal degradation in performance.</p>	<p>Low cost of ownership</p> <p>The Hypertac contact technology will surpass most product requirements, thus eliminating the burden and cost of having to replace the connector or the entire subsystem.</p>
<p>Lower contact resistance</p> <p>The design provides a far greater contact area and the wiping action of the wires insures a clean and polished contact surface. Our contact technology has about half the resistance of conventional contact designs.</p>	<p>Low power consumption</p> <p>The lower contact resistance of our technology results in a lower voltage drop across the connector reducing the power consumption and heat generation within the system.</p>
<p>Higher current ratings</p> <p>The design parameters of the contact (e.g., the number, diameter and angle of the wires) may be modified for any requirement. The number of wires can be increased so the contact area is distributed over a larger surface. Thus, the high current carried by each wire because of its intimate line contact, can be multiplied many times.</p>	<p>Maximum contact performance</p> <p>The lower contact resistance of the Hypertac contact reduces heat build-up; therefore Hypertac contacts are able to handle far greater current in smaller contact assemblies without the detrimental effects of high temperature.</p>
<p>Immunity to shock & vibration</p> <p>The low mass and resultant low inertia of the wires enable them to follow the most abrupt or extreme excursions of the pin without loss of contact. The contact area extends 360° around the pin and is uniform over its entire length. The 3 dimensional symmetry of the Hypertac contact design guarantees electrical continuity in all circumstances.</p>	<p>Reliability under harsh environments</p> <p>Harsh environmental conditions require connectors that will sustain their electrical integrity even under the most demanding conditions such as shock and vibration. The Hypertac contact provides unmatched stability in demanding environments when failure is not an option.</p>

Contents

M23 POWER CONNECTORS SERIES L	3
Type overview.....	3
Technical characteristics.....	4 - 5
How to order	6 - 7
Configuration available connectors:	8
Power Receptacles.....	8 - 10
Power Extensions.....	11 - 12
Power Panel Feed Through.....	13
Power Plugs	14 - 16
Cable Clamps & Accessoires	17
Contacts	18 - 22
M23 SIGNAL CONNECTORS SERIES S	24
Type overview.....	24
Technical characteristics.....	25
Contact arrangement.....	26 - 27
How to order	28 - 30
Configuration available connectors:	31
Signal Receptacles.....	31 - 37
Signal Extensions.....	38 - 45
Signal Plugs & Panel Feed Through	46 - 55
21 way Signal Connectors.....	56 - 58
Cable Clamps & Accessoires	59
Contacts	60 - 63
TOOLS	64 - 66

M23 Industrial

Robust Circular Power & Signal Connectors



M23 Signal and Power Connectors in favour of motor drive applications. For the installation, crimp contacts are used which guarantee high quality of the connection, reducing the installation costs at the same time.

Hand-operated and fully automatic crimping tools can be used to assemble the crimp contacts. There are two different Hypertac® hyperboloid contact types available: Machined and stamped. These two types of contacts have different characteristics in terms of how the termination is made.

Machined contacts: With this popular type of contact, the suitable contact size is matched to the wire gauge of the cable. **Stamped contacts:** The crimping sleeve allows a wider range of wire gauges to be crimped. Furthermore, the insertion and extraction force is usually lower by using stamped round pins and HCS™ sockets. Stamped contacts are supplied on reels for use with automatic feed crimping tools.

Hypertac® hyperboloid contact: Hypertac® is a superior performing hyperboloid contact technology designed for use in harsh and demanding environments where high reliability and safety are critical. The inherent electrical and mechanical characteristics of the Hypertac hyperboloid contact ensures unrivalled performance in terms of reliability, number of mating cycles, low contact force and minimal contact resistance. These performance characteristics provide a real commercial benefit in terms of the total installed cost of ownership.

In addition our M23 connectors offer outstanding electro-magnetic compatibility protection through a 360° screen connection.

Robust
technology
for use in harsh
environments

Features & Benefits

Superior performance

- Hypertac® contact technology ensures immunity to shock and vibration and minimal contact resistance
- Outstanding protection against electromagnetic interference through a full 360° screen shielding
- O-rings for protection against vibration

Variety of contacts

- Crimp contacts for all current cable cross sections available
- Signal connectors with crimp and solder contacts

Stamped hyperboloid contacts on reels

- Favourable price and reduced processing costs
- Fully automatic workable and reduced assembly time
- High reliability wire B-crimp and additional insulation O-crimp

Wide cable clamp range

- Can accept cable diameter from 5 to 18.5 mm

UL certified

- UL/CSA approval file No. 178462

Type Overview

M23 Power Connectors Series L



Cable plug with coupling ring



Cable plug with coupling ring



Cable plug with coupling ring

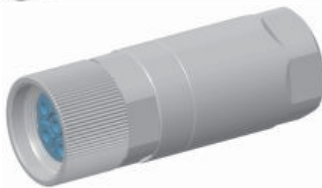

Cable plug with coupling ring

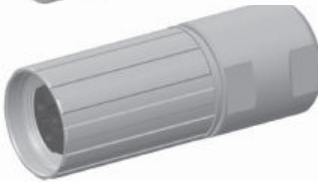

Cable plug with coupling ring



Cable extension with external thread



Cable extension with external thread



Cable extension with external thread



Cable extension with external thread



Straight receptacle with external thread



Straight receptacle with external thread



Straight receptacle with external thread



Fixed angled Straight receptacle with external thread



Rotatable angled Straight receptacle with external thread



Rotatable / fixed angled receptacle with external thread



Panel feed through with coupling ring

Technical Characteristics

M23 Power Connector Series L

Mechanical

Standards

Contact diameter 6poles	6 x Ø 2mm	–
Contact diameter 8poles	4 x Ø 2mm + 4 x Ø 1mm	–
Contact diameter 9poles	4 x Ø 2mm + 5 x Ø 1mm	–

Material

Shell	CuZn alloy, zinc die-cast	–
Machined contacts	CuZn alloy	–
Stamped contacts	Tin bronze, stainless steel	–
Inserts	PA	–
Sealing	FKM	–

Finishes

Shell plating	Nickel-plated, chromium plated	–
Machined contacts plating	Gold plated	–
Stamped contacts plating	Partly gold plated	–

Physical and environmental

Operating temperature range	-40°C... +125°C	EN 61984
Storage conditions	-40°C... +70°C / min. humidity 40%	–
Environmental level	IP67 (mated)	DIN EN 60529
Contamination level	2	DIN 60664-1
Installation altitude	Up to 2000 m	EN 61984
Fire & Smoke	Recognition file No E 178462	UL 1977
RoHS	Compliant	

Note:



For detailed information please contact factory and ask for data sheet.

Technical Characteristics

M23 Power Connector Series L

Electrical

Standards

Contact diameter				
	6 x 2	4 x 2	4 x 1	

Contact resistance (machined contacts)	$\leq 5.0 \text{ m}\Omega$ ($\varnothing 1\text{mm}$) $\leq 3.0 \text{ m}\Omega$ ($\varnothing 2\text{mm}$)	–
Contact resistance (stamped contacts)	$\leq 5.0 \text{ m}\Omega$ ($\varnothing 1\text{mm}$) $\leq 5.0 \text{ m}\Omega$ ($\varnothing 2\text{mm}$)	–
Overvoltage category	III	EN 61984

INNOVATION Series L (UL Version Series A)

Nominal voltage [Vrms]	630	630	250	–	DIN EN 60512
	600	600	250	–	USR
	600	600	250	–	CNR

SYSTEM 2000 Series L (UL Version Series A)

Nominal voltage [Vrms]	630	630	125	600	63	DIN EN 60512
	600	600	63	600	63	USR
	600	600	63	600	63	CNR

VERSION 1i Series L

Nominal voltage [Vrms]	630	630	125	–	DIN EN 60512
	600	600	125	–	USR



How to Order

M23 Power Connector Series L



1 CONNECTOR FAMILY

L M23 CIRCULAR POWER CONNECTORS, SIZE 1
SERIES L (UL VERSION = SERIES A)

2 CONNECTOR LAYOUT

INNOVATION

E	E	A	STRAIGHT RECEPTACLE, NICKEL-PLATED LONG VERSION
E	B	A	STRAIGHT RECEPTACLE, NICKEL-PLATED THREADED CONNECTION PG13.5
E	D	A	STRAIGHT RECEPTACLE, NICKEL-PLATED THREADED CONNECTION M20x1.5
E	A	B	FIXED ANGLED RECEPTACLE, CHROMIUM-PLATED
R	N	A	EXTENSION, NICKEL-PLATED, CABLE CLAMP Ø 7.7-14.5 mm
R	P	A	EXTENSION, NICKEL-PLATED, THREADED CONNECTION PG16, CABLE CLAMP Ø 7.7-14.5 mm

SYSTEM 2000

E	O	B	ROTATABLE ANGLED RECEPTACLE, CHROMIUM-PLATED
F	E	A	STRAIGHT RECEPTACLE, NICKEL-PLATED SHORT VERSION

VERSION 1i

G	D	G	ROTATABLE ANGLED RECEPTACLE, CHROMIUM-PLATED
G	F	G	FIXED ANGLED RECEPTACLE, CHROMIUM-PLATED
Y	M	A	EXTENSION, NICKEL-PLATED, CABLE CLAMP Ø 5-16 mm

R	F	A	EXTENSION, NICKEL-PLATED, THREADED CONNECTION M25x1.5, CABLE CLAMP Ø 7.7-14.5 mm
D	A	A	PANEL FEED THROUGH, NICKEL-PLATED, SQUARE FLANGE
P	N	A	PLUG, NICKEL-PLATED, CABLE CLAMP Ø 7.7-14.5 mm
P	R	A	PLUG, NICKEL-PLATED, SHORT VERSION, CABLE CLAMP Ø 7.7-14.5 mm
P	P	A	PLUG, NICKEL-PLATED, THREADED CONNECTION PG16, CABLE CLAMP Ø 7.7-14.5 mm
P	F	A	PLUG, NICKEL-PLATED, THREADED CONNECTION M25x1.5, CABLE CLAMP Ø 7.7-14.5 mm

R	L	A	EXTENSION, NICKEL-PLATED, CABLE CLAMP Ø 7.7-18.5 mm
P	L	A	PLUG, NICKEL-PLATED, CABLE CLAMP Ø 7.7-18.5 mm

V	L	A	PLUG, NICKEL-PLATED, MACHINED SOCKETS, CABLE CLAMP Ø 5-16 mm
V	M	A	PLUG, NICKEL-PLATED, STAMPED HCS™ SOCKETS, CABLE CLAMP Ø 5-16 mm

3 INSERTS

INNOVATION

0	6	A	6WAY, PINS 6 x Ø 2 mm, MACHINED CONTACTS
0	6	B	6WAY, SOCKETS 6 x Ø 2 mm; MACHINED CONTACTS
0	6	C	6WAY, PINS 6 x Ø 2 mm, MACHINED CONTACTS
0	6	D	6WAY, SOCKETS 6 x Ø 2 mm, MACHINED CONTACTS
0	8	K	8WAY, PINS 4 x Ø 1 mm, 4 x Ø 2 mm, MACHINED CONTACTS

VERSION 1i

0	6	E	6WAY, PINS 6 x Ø 2 mm, MACHINED CONTACTS
0	6	J	6WAY, PINS 6 x Ø 2 mm, MACHINED CONTACTS
0	6	M	6WAY, SOCKETS 6 x Ø 2 mm, MACHINED CONTACTS
0	6	F	6WAY, SOCKETS 6 x Ø 2 mm, STAMPED HCS™ CONTACTS

0	8	A	8WAY, PINS 4 x Ø 1 mm, 4 x Ø 2 mm, MACHINED CONTACTS
0	8	B	8WAY, SOCKETS 4 x Ø 1 mm, 4 x Ø 2 mm, MACHINED CONTACTS

0	8	L	8WAY, SOCKETS 4 x Ø 1 mm, 4 x Ø 2 mm, MACHINED CONTACTS
0	9	A	9WAY, PINS 5 x Ø 1 mm, 4 x Ø 2 mm, MACHINED CONTACTS
0	9	B	9WAY, SOCKETS 5 x Ø 1 mm, 4 x Ø 2 mm, MACHINED CONTACTS

0	8	T	8WAY, PINS 4 x Ø 1 mm, 4 x Ø 2 mm, MACHINED CONTACTS
0	8	X	8WAY, PINS 4 x Ø 1 mm, 4 x Ø 2 mm, MACHINED CONTACTS
0	8	Z	8WAY, SOCKETS 4 x Ø 1 mm, 4 x Ø 2 mm, MACHINED CONTACTS
0	8	U	8WAY, SOCKETS 4 x Ø 1 mm, 4 x Ø 2 mm, STAMPED HCS™ CONTACTS

How to Order

M23 Power Connectors Series L

4 TERMINATION STYLE - CRIMP CONTACTS

N	N	N	N	WITHOUT CONTACTS, CONTACTS TO BE ORDERED SEPARATELY, ALL CONNECTOR DESIGNS				
				INNOVATION				
M	R	C	N	PINS - Ø 2 mm AWG 20-16, RECEPTACLE	F	R	B	N
M	R	K	N	PINS - Ø 2 mm AWG 18-14, RECEPTACLE	F	R	D	N
M	R	E	C	PINS - Ø 1 mm, AWG 24-18, Ø 2 mm AWG 20-16, RECEPTACLE	F	R	H	N
M	R	E	K	PINS - Ø 1 mm, AWG 24-18, Ø 2 mm AWG 18-14, RECEPTACLE	F	R	K	B
M	R	P	N	PINS - Ø 2 mm AWG 16-14, EXTENSION	F	R	K	D
M	R	E	P	PINS - Ø 1 mm, AWG 24-18, Ø 2 mm AWG 16-14, EXTENSION				
				SYSTEM 2000				
M	R	S	N	PINS - Ø 2 mm AWG 18-14, RECEPTACLE	F	R	O	N
M	R	W	N	PINS - Ø 2 mm AWG 12, RECEPTACLE	F	R	R	N
M	R	R	S	PINS - Ø 1 mm, AWG 24-18, Ø 2 mm AWG 18-14, RECEPTACLE	F	R	F	O
M	R	R	W	PINS - Ø 1 mm, AWG 24-18, Ø 2 mm AWG 12, RECEPTACLE	F	R	F	R
M	R	T	U	PINS - Ø 1 mm, AWG 22-18/16, Ø 2 mm AWG 18-14/12, EXTENSION	F	R	P	O
					F	R	P	R
				VERSION 1i				
M	R	L	N	PINS - Ø 2 mm AWG 24-16, RECEPTACLE	M	R	I	N
M	R	Z	N	PINS - Ø 2 mm AWG 16-14, RECEPTACLE	M	R	Y	J
M	R	W	N	PINS - Ø 2 mm AWG 12, RECEPTACLE	M	R	Y	I
M	R	R	L	PINS - Ø 1 mm, AWG 24-18, Ø 2 mm AWG 24-16, RECEPTACLE	F	R	H	N
M	R	R	Z	PINS - Ø 1 mm, AWG 24-18, Ø 2 mm AWG 16-14, RECEPTACLE	F	R	U	N
M	R	R	W	PINS - Ø 1 mm, AWG 24-18, Ø 2 mm AWG 12, RECEPTACLE	F	R	F	H
M	R	J	N	PINS - Ø 2 mm AWG 22-16, EXTENSION	F	R	F	U

5 CABLE CLAMPING

0	0	0	WITHOUT CABLE CLAMP, ALL RECEPTACLES & PANEL FEED THROUGH	2	6	0	VARIABLE CABLE CLAMP, EXTENSION & PLUG VERSION 1i , CLAMP RANGE 5 – 9 mm
1	7	0	VARIABLE CABLE CLAMP, EXTENSION & PLUG INNOVATION , CLAMP RANGE 7.7 – 14.5 mm	2	6	1	VARIABLE CABLE CLAMP, EXTENSION & PLUG VERSION 1i , CLAMP RANGE 9 – 15 mm
2	1	3	VARIABLE CABLE CLAMP, EXTENSION & PLUG SYSTEM 2000 , CLAMP RANGE 7.7 – 18.5 mm	2	6	2	CABLE CLAMP, EXTENSION & PLUG VERSION 1i , CABLE DIAMETER 16 mm

6 VERSION NUMBER

0	1	DEPENDENT ON TYPE AND SPECIAL DESIGN, SEE DETAILED DESCRIPTION OF THE CONNECTOR DESIGN
----------	----------	--

Available Connectors

M23 Power Connector Series L

Power Receptacles - Innovation

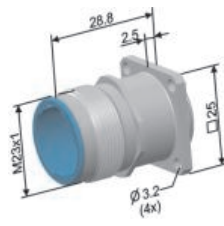
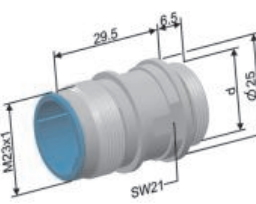
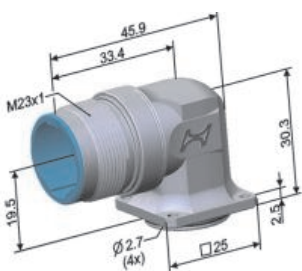
CONTACT ARRANGEMENTS VIEW MATING FACE			06A		08A		CABLE CLAMP			
	SHELL	INSERT	TERMINATION CROSS SECTION							
			AWG 20-16	AWG 18-14	AWG 24-18 AWG 20-16	AWG 24-18 AWG 18-14		without contacts		
LAYOUT DESCRIPTION PART NUMBER CONFIGURATOR	Straight receptacle, long version 	LEEA AEEA*	06A	MRCN				00002		
				MRKN					NNNN	
		08A			MREC					
						MREK			NNNN	
		Straight receptacle, threaded connection  <p>d = LEBA/AEBA PG13.5 LEDA M20x1.5</p>	LEBA AEBA*	06A	MRCN					000
					MRKN					
LEDA	08A				MREC					
						MREK	NNNN			
Fixed angled receptacle 	LEAB AEAB*		06A	MRCN				00002		
				MRKN					NNNN	
	08A				MREC					
						MREK	NNNN			

Dimensions are in mm

* UL Version

Power Receptacles - System 2000

CONTACT ARRANGEMENTS
VIEW MATING FACE

LAYOUT
DESCRIPTION
PART NUMBER CONFIGURATOR

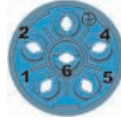

06C

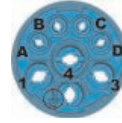

08K

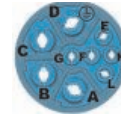

09A

TERMINATION CROSS SECTION

SHELL	INSERT	TERMINATION CROSS SECTION							CABLE CLAMP
		AWG 18-14	AWG 12	AEG 24-18 AWG 18-14	AWG 24-18 AWG 12	AWG 24-18 AWG 18-14	AWG 24-18 AWG 12	without contacts	
LEOB AEOB*	06C	MRSN							000
			MRWN					NNNN	
								NNNN	
	08K			MRRS					
					MRRW			NNNN	
								NNNN	
	09A					MRRS			
							MRRW		
								NNNN	
LFEA AFEA*	06C	MRSN						000	
			MRWN						NNNN
									NNNN
	08K			MRRS					
					MRRW				NNNN
									NNNN
	09A					MRRS			
							MRRW		
									NNNN

Rotatable angled receptacle

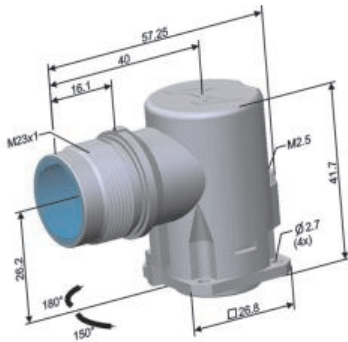

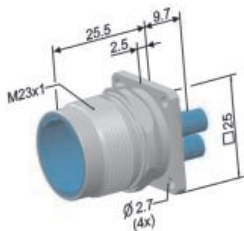

Straight receptacle, short version



Dimensions are in mm

* UL Version

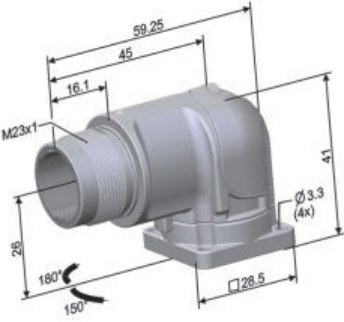
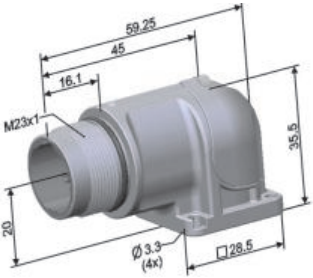

Power Receptacles - System 2000

CONTACT ARRANGEMENTS VIEW MATING FACE											
			06E		08T						
			TERMINATION CROSS SECTION								
LAYOUT DESCRIPTION PART NUMBER CONFIGURATOR	SHELL	INSERT	AWG 24-16	AWG 16-14	AWG 12	AWG 24-18 AWG 24-16	AWG 24-18 AWG 16-14	AG 24-18 AWG 12	without contacts	CABLE CLAMP	
Rotatable angled receptacle 	LGDG*	06E	MRLN							000	
				MRZN							
					MRWN						NNNN
		08T					MRRL				
								MRRZ			
									MRRW		NNNN
Fixed angled receptacle 	LGFG*	06E	MRLN							000	
				MRZN							NNNN
					MRWN						
		08T					MRRL				
								MRRZ			
									MRRW		NNNN

Dimensions are in mm

* UL Version

Power Extensions - Innovation

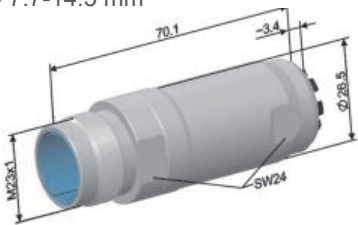
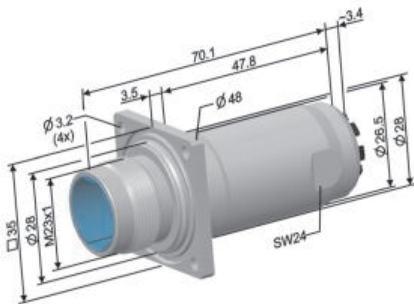
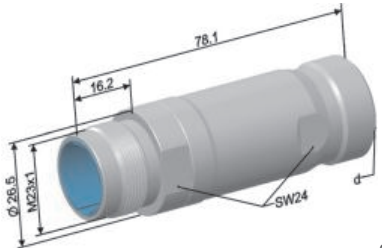
CONTACT ARRANGEMENTS VIEW MATING FACE	 		TERMINATION CROSS SECTION		CABLE CLAMP	
	SHELL	INSERT	AWG 16-14	AWG 24-18 AWG 16-14		
			without contacts			
LAYOUT DESCRIPTION PART NUMBER CONFIGURATOR						
Extension with cable clamp Ø 7.7-14.5 mm 	LRNA ARNA*	06A	MRPN		NNNN	170
	08A		MREP		NNNN	
Extension with cable clamp Ø 7.7-14.5 mm, square flange 	LRNA ARNA*	06A	MRPN		NNNN	17002
	08A		MREP		NNNN	
Extension with cable clamp Ø 7.7-14.5 mm, threaded connection 	LRPA ARPA*	06A	MRPN		NNNN	000
	LRFA ARFA*	08A		MREP	NNNN	

Dimensions are in mm

* UL Version

d =
LRPA/ARPA PG16
LRFA/ARFA M25x1.5

Power Extension - System 2000

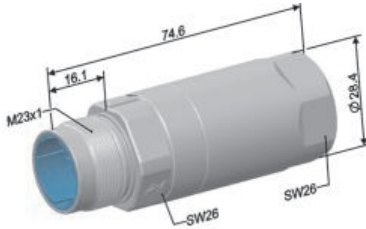
CONTACT ARRANGEMENTS VIEW MATING FACE	09A				CABLE CLAMP
	SHELL	INSERT	TERMINATION CROSS SECTION		
			AWG 22-18/16 AWG 18-14/12	without contacts	
LAYOUT DESCRIPTION PART NUMBER CONFIGURATOR					
Extension with cable clamp Ø 7.7-18.5 mm 	LRLA ARLA*	09A	MRTU		213
				NNNN	

Dimensions are in mm

* UL Version

Power Extension - Version 1i

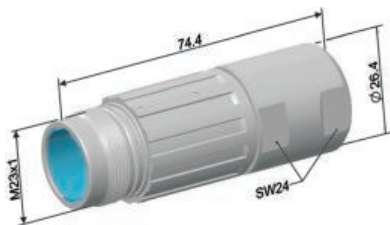
CONTACT ARRANGEMENTS VIEW MATING FACE	06J				08X		CABLE CLAMP	
	SHELL	INSERT	TERMINATION CROSS SECTION					
			AWG 22-16	AWG 16-12	AWG 24-16 AWG 22-16	AWG 24-16 AWG 16-12		without contacts
LAYOUT DESCRIPTION PART NUMBER CONFIGURATOR								
Extension with cable clamp Ø 5-16 mm 	LYMA*	06J	MRJN				260 261 262	
				MRIN				NNNN
		08X			MRYJ			
						MRYI		
								NNNN

Flange can be ordered separately ¹⁾



Dimensions are in mm

* UL Version

Note:

¹⁾ more information please contact factory

Power Panel Feed Through - Innovation

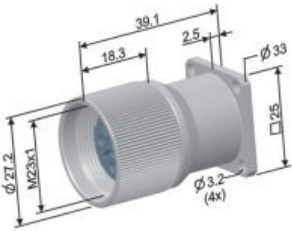
CONTACT ARRANGEMENTS VIEW MATING FACE			 					
			TERMINATION CROSS SECTION					
	SHELL	INSERT	AWG 20-16	AWG 18-14	AWG 24-18 AWG20-16	AWG 24-18 AWG 18-14	without contacts	
LAYOUT DESCRIPTION PART NUMBER CONFIGURATOR Panel feed through, square flange 	LDAA ADAA*	06B	FRBN					
				FRDN				
		08B						NNNN
						FRKB		
							FRKD	
								NNNN
							000	

Dimensions are in mm

* UL Version

Power Plugs - Innovation

CONTACT ARRANGEMENTS
VIEW MATING FACE

LAYOUT
DESCRIPTION
PART NUMBER CONFIGURATOR



06B

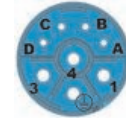

08B

TERMINATION CROSS SECTION

CONTACT ARRANGEMENTS VIEW MATING FACE	LAYOUT DESCRIPTION PART NUMBER CONFIGURATOR	SHELL	INSERT	TERMINATION CROSS SECTION					without contacts	CABLE CLAMP
				AWG 20-16	AWG 18-14	AWG 18-14 ¹⁾	AWG 24-18 AWG 20-16	AWG 24-18 AWG 18-14		
				FRBN	FRDN	FRHN	FRKB	FRKD		
Plug with cable clamp Ø 7.7-14.5 mm 	LPNA APNA*	06B					NNNN	170		
		08B							NNNN	
Plug with cable clamp Ø 7.7-14.5 mm, square flange 	LPNA APNA*	06B					NNNN	17003		
		08B							NNNN	
Plug with cable clamp Ø 7.7-14.5mm, short version 	LPRA APRA*	06B					NNNN	170		
		08B							NNNN	
Plug with cable clamp Ø 7.7-14.5 mm and threaded connection 	LPPA APPA* LPFA APFA*	06B					NNNN	000		
		08B							NNNN	

Dimensions are in mm

* UL Version

Note:

¹⁾ Terminals with insulation sleeve

Power Plugs - System 2000

CONTACT ARRANGEMENTS
VIEW MATING FACE

LAYOUT
DESCRIPTION
PART NUMBER CONFIGURATOR

Plug with cable clamp Ø 7.7-18.5 mm

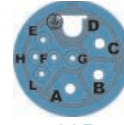
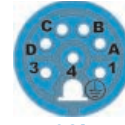
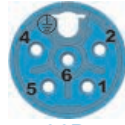
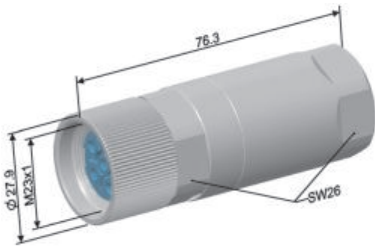

06D

08L

09B



TERMINATION CROSS SECTION

SHELL	INSERT	TERMINATION CROSS SECTION								CABLE CLAMP	
		AWG 18-14	AWG 18-12	AWG 24-18 AWG 18-14	AWG 24-18 AWG 18-12	AWG 26-16 AWG 18-14	AWG 26-16 AWG 18-12	AWG 24-18 AWG 18-14	AWG 26-16 AWG 18-12		without contacts
LPLA APLA*	06D	FRON									
			FRRN								
										NNNN	
	08L			FRFO							
					FRFR						
						FRPO					
							FRPR				
										NNNN	
											NNNN
	09B							FRFO			
									FRPR		
										NNNN	

Dimensions are in mm

* UL Version

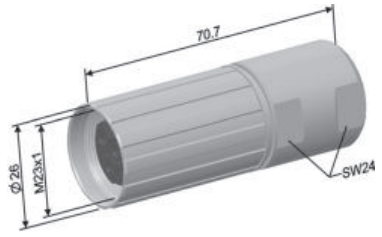

Power Plugs - Version 1i

CONTACT ARRANGEMENTS VIEW MATING FACE			 				CABLE CLAMP		
			TERMINATION CROSS SECTION						
	SHELL	INSERT	AWG 18-14	AWG 14-12	AWG 24-18 AWG 18-14	AWG 24-18 AWG 14-12		without contacts	
LAYOUT DESCRIPTION PART NUMBER CONFIGURATOR Plug with cable clamp \varnothing 5-16 mm, machined sockets 	LVLA*	06M	FRHN				260 261 262		
				FRUN					
		08Z				FRFH			NNNN
								FRFU	
									NNNN

Flange can be ordered separately ¹⁾

Dimensions are in mm

* UL Version

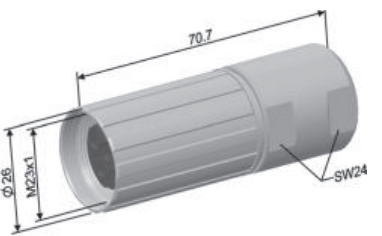
CONTACT ARRANGEMENTS VIEW MATING FACE			 				CABLE CLAMP
			CONTACTS TO BE ORDERED SEPARATELY STAMPED HCS™ CONTACTS ON REELS ²⁾				
	SHELL	INSERT	without contacts				
LAYOUT DESCRIPTION PART NUMBER CONFIGURATOR Plug with cable clamp \varnothing 5-16 mm, stamped HCS™ sockets 	LVMA*	06F	NNNN				260 261 262
		08U	NNNN				

Flange can be ordered separately ¹⁾

Dimensions are in mm

* UL Version







Note:

¹⁾ more information please contact factory

²⁾ contacts are shown on page 22

Cable Clamps & Accessories





M23 Power Connector Series L

<p>Cable clamp no. 170 for LPNA/LRNA</p>	<p>Clamp range</p>	
	<p>With reducing sleeve from Ø 7.7–12 mm Without reducing sleeve from Ø 11–14.5 mm Can be used for shielded and non-shielded cables</p>	
<p>Cable clamp no. 213 for LPLA/LRLA</p>	<p>Clamp range</p>	
	<p>Onion ring seal for different cable diameters from Ø 7.5–18.5 mm Thickness of shielding up to Ø 1 mm Can be used for shielded and non-shielded cables</p>	
<p>Cable clamp no. 260/261/262 for LVMA/LYMA</p>	<p>Clamp range</p>	
	<p>.260 cable diameter Ø 5–9 mm .261 cable diameter Ø 9–15 mm .262 cable diameter Ø 16mm Can be used for shielded and non-shielded cables</p>	
<p>Thread protection cap</p>	<p>Part number</p>	
	<p>031.001053.1000</p>	
<p>Dust shield caps</p>	<p>Part number</p>	<p>Description</p>
	<p>C/BEL/1</p>	<p>Dust shield cap for extension and receptacle</p>
	<p>C/BEL/7</p>	<p>Dust shield cap for extension and receptacle with chain 125 mm</p>
	<p>C/BEL/5</p>	<p>Dust shield cap for plug with chain 125 mm</p>





Contacts

M23 Power Connector Series L

Machined Pins - Innovation

Type		E	C	K	P	
Contact diameter [mm]		1	2	2	2	
PART NUMBER AND LAYOUT						
		021.129.1020	021.101.2000	021.147.2000	021.279.1020	
	Termination cross section ¹⁾	[AWG] [mm ²]	24 – 18 0.24 – 1	20 – 16 0.5 – 1.5	18 – 14 0.75 – 2.5	16 – 14 1.5 – 2.5
	Nominal current @ 20°C [A] ²⁾	VDE USR CNR	9 8 7	20 20 14	20 20 14	20 20 14
Crimping tool		B150	B151	B151	B151	
Positioner		B055/A	B157	B157	B165	

Hypertac[®] Sockets - Innovation





Type		K	B	D	H	
Contact diameter [mm]		1	2	2	2	
PART NUMBER AND LAYOUT						
		020.232.2000	020.090.1020	020.105.1020	020.123.1020	
	Termination cross section ¹⁾	[AWG] [mm ²]	24 – 18 0.24 – 1	20 – 16 0.5 – 1.5	18 – 14 0.75 – 2.5	18 – 14 0.75 – 2.5
	Nominal current @ 20°C [A]	VDE USR CNR	9 8 7	20 20 14	22 20 14	22 20 12
Crimping tool		B150	B151	B151	B151	
Positioner		B055/A	B157	B157	B154	

Note:





¹⁾ Mentioned crimp ranges are recommendations and only valid with flexible wires H05(07)V-K [mm²] acc. to DIN VDE 0281/0282 pp and with non compressed standard cables and wires acc. to DIN VDE 0295. It is possible that due to another structure of wired further cross sections and currents can be processed.

²⁾ data only valid when plugged with Hypertac sockets.

Machined Pins - System 2000

Type		R	T	S	W	U
Contact diameter [mm]		1	1	2	2	2
PART NUMBER AND LAYOUT		021.382.1020 	021.385.1020 	021.380.1020 	021.415.1020 	021.384.1020 
Termination cross section ¹⁾	[AWG] [mm ²]	24 – 18 0.24 – 1	22 – 18/16 0.34 – 1/1.5	18 – 14 0.75 – 2.5	12 4	18 – 14/12 0.75 – 2.5/4
Nominal current @ 20°C [A] ²⁾	VDE	9	9	30	30	30
	USR	9	9	30	30	30
	CNR	7.5	7.5	18	18	18
Crimping tool		B151	B151	B179	B179	B179
Positioner		B245	B252	B245	B245	B252

Hypertac® Sockets - System 2000

Type		F	P	O	R
Contact diameter [mm]		1	1	2	2
PART NUMBER AND LAYOUT		020.256.1020 	020.332.1020 	020.331.1020 	020.281.1020 
Termination cross section ¹⁾	[AWG] [mm ²]	24 – 18 0.24 – 1	26 - 16 0.14 – 1.5	18 – 14 0.75 – 2.5	18 – 12 1 – 4
Nominal current @ 20°C [A]	VDE	9	9	30	30
	USR	9	9	30	30
	CNR	7.5	7.5	18	18
Crimping tol		B150	B151	B151	B179
Positioner		B055/A	B252	B252	B252





Note:

¹⁾ Mentioned crimp ranges are recommendations and only valid with flexible wires H05(07)V-K [mm²] acc. to DIN VDE 0281/0282 pp and with non compressed standard cables and wires acc. to DIN VDE 0295.



It is possible that due to another structure of wired further cross sections and currents can be processed.

²⁾ data only valid when plugged with Hypertac sockets.

Machined Pins - Version 1i

Type		R	W	L	Z
Contact diameter [mm]		1	2	2	2
PART NUMBER AND LAYOUT		021.382.1020 	021415.1020 	021.001009.1020 	021.001004.1020 
Termination cross section ¹⁾	[AWG] [mm ²]	24 – 18 0.24 – 1.0	12 4	24 – 16 0.24 – 1.5	16 – 14 1.5 – 2.5
Nominal current @ 20°C [A] ²⁾	VDE USR CNR	9 9 7.5	30 30 18	30 30 -	30 30 -
Crimping tool		B151	B179	B151	B179
Positioner		B245	B245	B297	B297



Machined Pins - Version 1i

Type		Y	J	I
Contact diameter [mm]		1	2	2
PART NUMBER AND LAYOUT		021.001017.1020 	021.001025.1020 	021.001018.1020 
Termination cross section ¹⁾	[AWG] [mm ²]	24 - 16 0.24 - 1.5	22 - 16 0.34 - 1.5	16 - 12 1.5 - 4
Nominal current @ 20°C [A] ²⁾	VDE USR CNR	9 8 -	30 30 -	30 30 -
Crimping tool		B151	B151	B179
Positioner		B306	B305	B305

Note:

¹⁾ Mentioned crimp ranges are recommendations and only valid with flexible wires H05(07)V-K [mm²] acc. to DIN VDE 0281/0282 pp and with non compressed standard cables and wires acc. to DIN VDE 0295. It is possible that due to another structure of wired further cross sections and currents can be processed.
²⁾ data only valid when plugged with Hypertac sockets.





Hypertac® Sockets - Version 1i

Type		F	H	U
Contact diameter [mm]		1	2	2
PART NUMBER AND LAYOUT		020.256.1020 	020.123.1020 	020.001011.1020 
Termination cross section ¹⁾	[AWG] [mm ²]	24 – 18 0.24 – 1	18 – 14 0.75 – 2.5	14 – 12 2.5 – 4.0
Nominal current @ 20°C [A]	VDE USR CNR	9 9 7.5	20 12 -	30 - -
Crimping tool		B150	B151	B151
Positioner		B055/A	B154	B341



Note:

¹⁾ Mentioned crimp ranges are recommendations and only valid with flexible wires H05(07)V-K [mm²] acc. to DIN VDE 0281/0282 pp and with non compressed standard cables and wires acc. to DIN VDE 0295. It is possible that due to another structure of wired further cross sections and currents can be processed.

HCS™ Stamped Sockets Ø 1mm - Version 1i

Type		A	B	C	D	
Contact diameter [mm]		1	1	1	1	
PART NUMBER AND LAYOUT						
		020.000376.2000	020.000377.2000	020.000378.2000	020.000379.2000	
	Termination cross section ¹⁾	[AWG] [mm²]	32 – 28 0.03 – 0.08	28 – 24 0.08 – 0.2	24 – 20 0.2 – 0.5	- 0.75 - 1.0
	Nominal current @ 20°C [A]	VDE USR CNR	4 9 -	6 9 -	8 9 -	8 9 -
Hand crimping tool with feeder line for small reels		B287/32-28	B287/28-24	B287/24-20	B287/0.75-1	
Applicator for Schäfer/AMP crimping machines		B288/32-28	B288/28-24	B288/24-20	B288/0.75-1	
Applicator for Kirsten PP3 crimping machine		B286/32-28	B286/28-24	B286/24-20	B286/0.75-1	
Number of contacts on reel	[Pieces]	9000	9000	9000	9000	
Number of contacts on small reel	[Pieces]	300	300	300	300	

HCS™ Stamped Sockets Ø 1mm - Version 1i

Type		E	F	G
Contact diameter [mm]		2	2	2
PART NUMBER AND LAYOUT				
		020.001001.2000	020.001002.2000	020.001003.2000
	Termination cross section ¹⁾	[AWG] [mm²]	20 - 18 0.5 - 1.0	18 - 14 1.0 - 2.0
Nominal current @ 20°C [A]	VDE USR CNR	12 12 -	18 18 -	30 30 -
Hand crimping tool with feeder line for small reels		B295/0.5-1	B295/1.0-2.0	B295/2.5-4.0
Applicator for Schäfer/AMP crimping machines		on demand	on demand	on demand
Applicator for Kirsten PP3 crimping machine		on demand	on demand	on demand
Number of contacts on reel	[Pieces]	4000	3500	2500
Number of contacts on small reel	[Pieces]	150	150	150

¹⁾ Mentioned crimp ranges are recommendations and only valid with flexible wires H05(07)V-K [mm²] acc. to DIN VDE 0281/0282 pp and with non compressed standard cables and wires acc. to DIN VDE 0295. It is possible that due to another structure of wired further cross sections and currents can be processed.

Applications

M23 Connectors



Servos & Drives



- High current and voltage ratings
- Shock and vibration proof
- Low contact resistance
- Minimal insertion/extraction forces
- Earth connection for power connectors

Controls



- Hyperboloid contacts
- IP67 sealing
- Low electrical resistance
- Long life
- Low rate of wear

Encoders



- High signal integrity ensuring failure free performance
- 360° EMC shielding connection
- Stamped hyperboloid contacts on reels
- High performance in harsh environment

Machinery



- Minimum service requirements
- Low wear of plating surfaces for long life
- High current rating
- Uniform electrical and mechanical characteristics over a high number of operations

Conveyance



- Resistance against oxidation and corrosion
- Superior reliability for critical applications
- Protection against humidity and pollution
- Customized keying options to prevent mismatching

















Robotics



- Various types of cable clamps
- Broad variety of contacts
- Quick and easy exchange of the connector system
- ROHS compliant
- UL certified

Type Overview

M23 Signal Connectors Series S

- | | | | |
|---|---|--|---|
|  | Cable plug with coupling ring |  | Cable extension with external thread |
|  | Cable plug with coupling ring |  | Cable extension with external thread |
|  | Cable plug with coupling ring |  | Straight receptacle with external thread |
|  | Cable plug with coupling ring |  | Straight receptacle with external thread |
|  | Cable plug with coupling ring |  | Fixed angled receptacle with external thread |
|  | Cable plug with coupling ring |  | Rotatable / fixed angled receptacle with external thread |
|  | Cable extension with external thread |  | Rotatable / fixed angled receptacle with external thread |
|  | Cable extension with external thread |  | Panel feed through with coupling ring |
|  | Cable extension with external thread | | |

Technical Characteristics

M23 Signal Connectors Series S

Mechanical

Standards

Contact diameter 6/7poles	6/7 x Ø 2mm	–
Contact diameter 9poles	8 x Ø 1mm + 1 x Ø 2mm 6 x Ø 1mm + 3 x Ø 2mm 9 x Ø 1mm	– – –
Contact diameter 12/16/17poles	12/16/17 x Ø 1mm	–
Contact diameter 21poles	21 x Ø 0.6mm	–

Material

Shell	CuZn alloy, zinc die-cast, plastic	–
Machined contacts	CuZn alloy	–
Stamped contacts	Tin bronze, stainless steel	–
Inserts	PA, PPS, PBT	–
Sealing	FKM, NBR	–

Finishes

Shell plating	Nickel-plated, chromium plated	–
Machined contacts plating	Gold plated	–
Stamped contacts plating	partly gold plated	–

Electrical











Contact resistance	<5 mΩ	
Overvoltage categorie	III	EN 61984





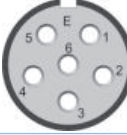
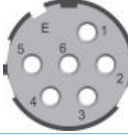
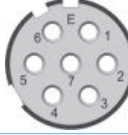
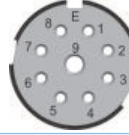

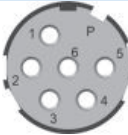

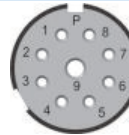







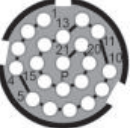

Physical and Environmental

Operating temperature range	-40°C ... 125°C	EN 61984
Storage conditions	-40°C ... 70°C / min. humidity 40%	-
Environmental level	IP67 (mated)	DIN EN 60529
Contamination level	3	DIN 60664-1
Installation altitude	up to 2000 m	EN 61984
Fire & Smoke	Recognition file No E 178462	UL 1977
RoHS	Compliant	

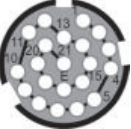
Contact Arrangements (w/electrical data - view mating face)

M23 Signal Connectors Series S

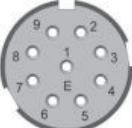
Contact Arrangements		6 x 2	6 x 2	7 x 2	8 x 1 1 x 2
INSERTS FOR PLUGS AND PANEL FEED THROUGH CRIMP CONTACTS					
			06H	07D	09F
Part number			030.704.2000	030.637.2000	030.627.2000
INSERTS FOR RECEPTACLES AND EXTENSIONS CRIMP CONTACTS					
			06G	07C	09E
Part number			030.697.2000	030.635.2000	030.625.2000
Operating Voltage [V]	VDE (DC)		120	120	120
IEC 60449	VDE (AC)		50	50	50
UL 1977	USR (AC)		125	125	125
INSERTS FOR RECEPTACLES IP67 UNMATED CRIMP PINS					
Part number	SEAB/UEAB SFOA/SFRA				
Operating Voltage [V]	VDE (DC)				
IEC 60449	VDE (AC)				
UL 1977	USR (AC)				
INSERTS FOR RECEPTACLES AND EXTENSIONS SOLDER CONTACTS					
		06C	06E	07A	09C
Part number	with pins	060.031.2000	1.164	1.085	1.053
	with Hypertac sockets	060.032.2000	1.139	1.086	1.056
INSERTS FOR PLUGS SOLDER CONTACTS					
		06D	06F	07B	09D
Part number	with pins	060.029.2000	1.141	1.083	1.055
	with Hypertac sockets	060.030.2000	1.142	1.084	1.054
Operating Voltage [V]	VDE (DC)	120	63	120	16
IEC 60449	VDE (AC)	50	50	50	16

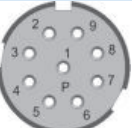
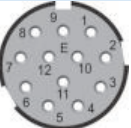
6 x 1 3 x 2	9 x 1	12 x 1	12 x 1 code 20°	16 x 1	17 x 1	21 x 0.6
						
09H	09K	12S	12U	16B	17H	21B
030.629.2000	030.677.2000	030.619.2000	030.623.2000	030.691.2000	030.679.2000	030.226.1000
						
09G	09J	12T	12V	16A	17G	21A
030.631.2000	030.676.2000	030.617.2000	030.621.2000	030.701.2000	030.678.2000	030.225.1000
120	120	120	120	120	120	32
50	50	50	50	50	50	32
125	125	125	125	125	125	-
						
		12A	12C		17A	
		030.400.2000 030.505.2000	030.387.2000 030.506.2000		030.479.2000 030.504.2000	
		120	120		120	
		50	50		50	
		125	125		125	
						
	09A	12E				
	1.129	1.023				
	1.130	1.050				
						
	09B	12F				
	1.132	1.049				
	1.120	1.024				
	120	120				
	50	50				

How to Order

M23 Signal Connectors Series S



1 CONNECTOR FAMILY

S M23 CIRCULAR SIGNAL CONNECTORS, SERIES S

2 CONNECTOR LAYOUT

RECEPTACLES IP67 UNMATED

F	O	A	STRAIGHT RECEPTACLE, NICKEL-PLATED
F	R	A	STRAIGHT RECEPTACLE, NICKEL-PLATED, THREADED CONNECTION PG13.5
E	A	B	FIXED ANGLED RECEPTACLE, CHROMIUM-PLATED

RECEPTACLES CRIMP

F	F	A	STRAIGHT RECEPTACLE, NICKEL-PLATED
F	Q	A	STRAIGHT RECEPTACLE, NICKEL-PLATED, THREADED CONNECTION M20x1.5
F	L	A	STRAIGHT RECEPTACLE, NICKEL-PLATED, THREADED CONNECTION PG13.5
F	T	A	STRAIGHT RECEPTACLE, NICKEL-PLATED, 21WAY ONLY

EXTENSIONS SOLDER & CRIMP

R	N	A	EXTENSION, NICKEL-PLATED, CABLE CLAMP Ø 5.5-12 mm
R	R	A	EXTENSION, NICKEL-PLATED, CABLE CLAMP Ø 5.5-12 mm, THREADED CONNECTION M20x1.5
R	G	A	EXTENSION, NICKEL-PLATED, CABLE CLAMP Ø 5.5-12 mm, THREADED CONNECTION PG13.5

EXTENSIONS CRIMP

R	F	A	EXTENSION, NICKEL-PLATED, CABLE CLAMP Ø 7.7-14.5 mm
V	R	A	EXTENSION, NICKEL-PLATED, CABLE CLAMP Ø 5-16 mm

PLUGS SOLDER & CRIMP

P	N	A	PLUG, NICKEL-PLATED, CABLE CLAMP Ø 5.5-12 mm
P	R	A	PLUG, NICKEL-PLATED, CABLE CLAMP Ø 5.5-12 mm, THREADED CONNECTION M20x1.5
P	G	A	PLUG, NICKEL-PLATED, CABLE CLAMP Ø 5.5-12 mm, THREADED CONNECTION PG13.5
P	H	A	ANGLED PLUG, NICKEL-PLATED, CABLE CLAMP Ø 7.7-14.5 mm

PLUGS CRIMP

P	F	A	PLUG, NICKEL-PLATED, CABLE CLAMP Ø 7.7-14.5 mm
V	P	A	PLUG, NICKEL-PLATED, CABLE CLAMP Ø 5-16 mm

RECEPTACLES SOLDER

F	N	A	STRAIGHT RECEPTACLE, NICKEL-PLATED
F	P	A	STRAIGHT RECEPTACLE, NICKEL-PLATED, THREADED CONNECTION PG13.5

RECEPTACLES CRIMP

F	M	B	ROTATABLE ANGLED RECEPTACLE, CHROMIUM-PLATED
F	Y	B	FIXED ANGLED RECEPTACLE, CHROMIUM-PLATED
G	D	G	ROTATABLE ANGLED RECEPTACLE, CHROMIUM-PLATED
G	F	G	FIXED ANGLED RECEPTACLE, CHROMIUM-PLATED

EXTENSIONS SOLDER & CRIMP

R	O	C	EXTENSION, PLASTIC SHELL CABLE CLAMP Ø 5.5-12 mm
R	U	C	EXTENSION, PLASTIC SHELL, CABLE SPECIFIC CABLE CLAMPS
R	W	C	EXTENSION, PLASTIC SHELL, CABLE SPECIFIC CABLE CLAMPS, SQUARE FLANGE

PLUGS SOLDER & CRIMP

P	O	C	PLUG, PLASTIC SHELL CABLE CLAMP Ø 5.5-12 mm
P	U	C	PLUG, PLASTIC SHELL, CABLE SPECIFIC CABLE CLAMPS
P	Y	C	PLUG, PLASTIC SHELL, CABLE SPECIFIC CABLE CLAMPS, SQUARE FLANGE

PANEL FEED THROUGH CRIMP

D	B	A	PANEL FEED THROUGH, NICKEL-PLATED SQUARE FLANGE
---	---	---	---

How to Order

M23 Signal Connectors Series S

3 INSERTS

FOR CRIMP PINS (RECEPTACLES IP67 UNMATED)

0	0	0
1	2	A

WITHOUT INSERT,
INSERTS TO BE ORDERD SEPARATELY

12WAY, FOR PINS 12 x Ø 1 mm

1	2	C
1	7	A

12WAY, CODE 20°, FOR PINS Ø 12 x 1 mm

17WAY, FOR PINS 17 x Ø 1 mm

FOR SOLDER CONTACTS

0	0	0
0	6	C
0	6	D
0	6	E
0	6	F
0	7	A
0	7	B

WITHOUT INSERT,
INSERTS TO BE ORDERD SEPARATELY

6WAY, FOR CONTACTS 6 x Ø 2 mm
E-PART

6WAY, FOR CONTACTS 6 x Ø 2 mm
P-PART

6WAY, FOR CONTACTS 6 x Ø 2 mm
E-PART

6WAY, FOR CONTACTS 6 x Ø 2 mm
P-PART

7WAY, FOR CONTACTS 7 x Ø 2 mm
E-PART

7WAY, FOR CONTACTS 7 x Ø 2 mm
P-PART

FOR SOLDER CONTACTS

0	9	C
0	9	D
0	9	A
0	9	B
1	2	E
1	2	F

9WAY, FOR CONTACTS 8 x Ø 1 + 1 x Ø 2 mm
E-PART

9WAY, FOR CONTACTS 8 x Ø 1 + 1 x Ø 2 mm
P-PART

9WAY, FOR CONTACTS 9 x Ø 1 mm
P-PART

9WAY, FOR CONTACTS 9 x Ø 1 mm
E-PART

12WAY, FOR CONTACTS 12 x Ø 1 mm
P-PART

12WAY, FOR CONTACTS 12 x Ø 1 mm
E-PART

FOR CRIMP CONTACTS

0	0	0
0	6	G
0	6	H
0	7	C
0	7	D
0	9	E
0	9	F
0	9	G
0	9	H
0	9	J
0	9	K

WITHOUT INSERT,
INSERTS TO BE ORDERD SEPARATELY

6WAY, FOR CONTACTS 6 x Ø 2 mm
E-PART

6WAY, FOR CONTACTS 6 x Ø 2 mm
P-PART

7WAY, FOR CONTACTS 7 x Ø 2 mm
E-PART

7WAY, FOR CONTACTS 7 x Ø 2 mm
P-PART

9WAY, FOR CONTACTS 8 x Ø 1 + 1 x Ø 2 mm
E-PART

9WAY, FOR CONTACTS 8 x Ø 1 + 1 x Ø 2 mm
P-PART

9WAY, FOR CONTACTS 6 x Ø 1 + 3 x Ø 2 mm
E-PART

9WAY, FOR CONTACTS 6 x Ø 1 + 3 x Ø 2 mm
P-PART

9WAY, FOR CONTACTS 9 x Ø 1 mm
E-PART

9WAY, FOR CONTACTS 9 x Ø 1 mm
P-PART

FOR CRIMP CONTACTS

1	2	S
1	2	T
1	2	U
1	2	V
1	6	A
1	6	B
1	7	G
1	7	H
2	1	A
2	1	B

12WAY, FOR CONTACTS 12 x Ø 1 mm
E-PART

12WAY, FOR CONTACTS 12 x Ø 1 mm
P-PART

12WAY, CODE 20°, FOR CONTACTS 12 x Ø 1 mm
E-PART

12WAY, CODE 20°, FOR CONTACTS 12 x Ø 1 mm
P-PART

16WAY, FOR CONTACTS 16 x Ø 1 mm
E-PART

16WAY, FOR CONTACTS 16 x Ø 1 mm
P-PART

17WAY, FOR CONTACTS 17 x Ø 1 mm
E-PART

17WAY, FOR CONTACTS 17 x Ø 1 mm
P-PART

21WAY, FOR CONTACTS 21 x Ø 0.6 mm
E-PART

21WAY, FOR CONTACTS 21 x Ø 0.6 mm
P-PART

How to Order

M23 Signal Connectors Series S



4 TERMINATION STYLE

WITH CRIMP PINS (RECEPTACLES IP67 UNMATED)

N	N	N	N
M	R	A	N

WITHOUT PINS,
PINS TO BE ORDERED SEPARATELY

PINS, Ø 1 mm,
AWG 26 - 22

M	R	E	N
M	R	M	N

PINS, Ø 1 mm,
AWG 24 - 18

PINS, Ø 1 mm, AWG 24 - 18
(terminals with insulation sleeves)

WITH CRIMP CONTACTS

N	N	N	N
M	R	R	N
M	R	V	N
M	R	S	R
M	R	S	V
M	R	W	R
M	R	W	V
M	R	S	N
M	R	W	N
M	R	G	N

WITHOUT CONTACTS, MACHINED OR
STAMPED CONTACTS TO BE ORDERED SEPARATELY

PINS - Ø 2 mm,
AWG 18 - 14

PINS - Ø 2 mm,
AWG 22 - 16

PINS - Ø 1 mm + Ø 2 mm,
AWG 24 - 18, AWG 18 - 14

PINS - Ø 1 mm + Ø 2 mm,
AWG 24 - 18, AWG 22 - 16

PINS - Ø 1 mm + Ø 2 mm,
AWG 30 - 22, AWG 18 - 14

PINS - Ø 1 mm + Ø 2 mm,
AWG 30 - 22, AWG 22 - 16

PINS - Ø 1 mm,
AWG 24 - 18

PINS - Ø 1 mm,
AWG 30 - 22

PINS - Ø 0.6 mm,
AWG 26 - 22

F	R	R	N
F	R	M	N
F	R	O	R
F	R	O	M
F	R	B	R
F	R	B	M
F	R	O	N
F	R	B	N
F	R	F	N

HYPERTAC SOCKETS - Ø 2 mm,
AWG 20 - 16

HYPERTAC SOCKETS - Ø 2 mm,
AWG 18 - 14

HYPERTAC SOCKETS - Ø 1 mm + Ø 2 mm,
AWG 24 - 18, AWG 20 - 16

HYPERTAC SOCKETS - Ø 1 mm + Ø 2 mm,
AWG 24 - 18, AWG 18 - 14

HYPERTAC SOCKETS - Ø 1 mm + Ø 2 mm,
AWG 30 - 22, AWG 20 - 16

HYPERTAC SOCKETS - Ø 1 mm + Ø 2 mm,
AWG 30 - 22, AWG 18 - 14

HYPERTAC SOCKETS - Ø 1 mm,
AWG 24 - 18

HYPERTAC SOCKETS - Ø 1 mm,
AWG 30 - 22

HYPERTAC SOCKETS - Ø 0.6 mm,
AWG 26 - 22

WITH SOLDER CONTACTS (built-in)

M	S	B	N
M	S	A	B
M	S	A	N

PINS - Ø 2 mm

PINS - Ø 1 mm + Ø 2 mm

PINS - Ø 2 mm

F	S	B	N
F	S	A	B
F	S	A	N

HYPERTAC SOCKETS - Ø 2 mm

HYPERTAC SOCKETS - Ø 1 mm + Ø 2 mm

HYPERTAC SOCKETS - Ø 2 mm

5 CABLE CLAMPING

0	0	0
1	6	9
1	7	0
.	.	.

WITHOUT CABLE CLAMP,
ALL RECEPTACLES & PANEL FEED THROUGH

VARIABLE CABLE CLAMP, EXTENSION & PLUG
CLAMP RANGE 5.5 – 12 mm

VARIABLE CABLE CLAMP, EXTENSION & PLUG
CLAMP RANGE 7.7 – 14.5 mm

SPECIFIC CABLE CLAMP, CONNECTORS WITH
PLASTIC SHELL, PLEASE CONTACT FACTORY

2	6	0
2	6	1
2	6	2

VARIABLE CABLE CLAMP, EXTENSION & PLUG
CLAMP RANGE 5-9 mm

VARIABLE CABLE CLAMP, EXTENSION & PLUG
CLAMP RANGE 9-15 mm

CABLE CLAMP, EXTENSION & PLUG
CABLE DIAMETER 16 mm

6 VERSION NUMBER

0	1
---	---

DEPENDENT ON TYPE AND SPECIAL DESIGN, SEE
DETAILED DESCRIPTION OF THE CONNECTOR DESIGN



Note:

¹⁾ Contacts are shown on page 60 – 63

Available Connectors

M23 Signal Connectors Series S

Signal receptacles - IP67 unmated

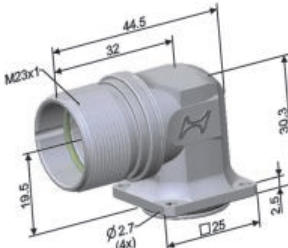
LAYOUT DESCRIPTION PART NUMBER CONFIGURATOR	SHELL	CONTACT STYLE	TERMINATION CROSS SECTION	CONTACT ARRANGEMENTS VIEW MATING FACE			CABLE CLAMP			
				12A 12 x 1	12C 12 x 1 (code 20°)	17A 17 x 1				
Straight receptacle 	SFOA	MACHINED CRIMP PINS	AWG 26-22	12A	12C	17A	000			
AWG 24-18			MRAN					MRAN	MRAN	
AWG 24-18 ¹⁾			MREN					MREN	MREN	
without contacts ²⁾			MRMN					MRMN	MRMN	
Straight receptacle, threaded connection PG13.5 	SFRA	MACHINED CRIMP PINS	AWG 26-22	12A	12C	17A	000			
			AWG 24-18					MRAN	MRAN	MRAN
			AWG 24-18 ¹⁾					MREN	MREN	MREN
			without contacts ²⁾					MRMN	MRMN	MRMN
Fixed angled receptacle 	SEAB UEAB*	MACHINED CRIMP PINS	AWG 26-22	12A	12C	17A	000			
			AWG 24-18					MRAN	MRAN	MRAN
			AWG 24-18 ¹⁾					MREN	MREN	MREN
			without contacts ²⁾					MRMN	MRMN	MRMN

Dimensions are in mm

* UL Version

Note:

¹⁾ Terminals with insulation sleeves, ²⁾ Machined contacts are shown on page 60-61

Signal receptacles with solder contacts 6 - 12way

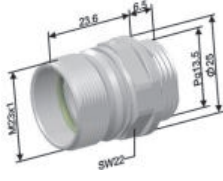
LAYOUT DESCRIPTION PART NUMBER CONFIGURATOR	SHELL	NUMBER OF CONTACTS	CONTACT ARRANGEMENTS VIEW MATING FACE			
			06C 6 x 2	06E 6 x 2		
		CONTACT STYLE	CONTACT ARRANGEMENTS VIEW MATING FACE			
Straight receptacle 	SFNA	PINS WITH SOLDER CUP	06C	MSBN	06E	MSBN
		SOCKETS WITH SOLDER CUP		FSBN		FSBN
Straight receptacle with threaded connection PG 13.5 	SFPA	PINS WITH SOLDER CUP	06C	MSBN	06E	MSBN
		SOCKETS WITH SOLDER CUP		FSBN		FSBN



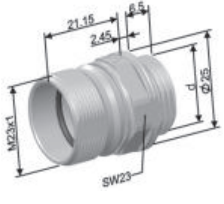

Dimensions are in mm

								CABLE CLAMP
<p>07A 7 x 2</p>		<p>09C 8 x 1 / 1 x 2</p>		<p>09A 9 x 1</p>		<p>12E 12 x 1</p>		
CONTACT ARRANGEMENTS VIEW MATING FACE								
07A	MSBN	09C	MSAB	09A	MSAN	12E	MSAN	000
	FSBN		FSAB		FSAN		FSAN	
07A	MSBN	09C	MSAB	09A	MSAN	12E	MSAN	000
	FSBN		FSAB		FSAN		FSAN	

Signal receptacles for crimp contacts 6 - 17way







LAYOUT DESCRIPTION PART NUMBER CONFIGURATOR	SHELL
Straight receptacle 	SFFA*
Straight receptacle with threaded connection  <p style="margin-left: 20px;">d = SFQA = M20x1.5 SFLA = PG 13.5</p>	SFQA* SFLA*

Dimensions are in mm * UL Version



CONTACT STYLE GENDER REVERSIBLE	TERMINATION CROSS SECTION	CONTACT ARRANGEMENTS VIEW MATING FACE			
		 06G 6 x 2		 07C 7 x 2	
MACHINED CRIMP PINS	AWG 18-14	06G	MRRN	07C	MRRN
	AWG 22-16		MRVN		MRVN
	AWG 24-18, 18-14		-		-
	AWG 24-18, 22-16		-		-
	AWG 30-22, 18-14		-		-
	AWG 30-22, 22-16		-		-
	AWG 24-18		-		-
	AWG 30-22		-		-
MACHINED CRIMP SOCKETS	AWG 20-16	06G	FRRN	07C	FRRN
	AWG 18-14		FRMN		FRMN
	AWG 24-18, 20-16		-		-
	AWG 24-18, 18-14		-		-
	AWG 30-22, 20-16		-		-
	AWG 30-22, 18-14		-		-
	AWG 24-18		-		-
	AWG 30-22		-		-
MACHINED CONTACTS	CONTACTS TO BE ORDERED SEPARATELY ¹⁾ 	06G	NNNN	07C	NNNN
STAMPED HCS TM CONTACTS	CONTACTS ON REELS TO BE ORDERED SEPARATELY ²⁾ 		-		-

Note:

¹⁾ Machined contacts are shown on page 60-61, ²⁾ Stamped contacts are shown on page 62-63

														CABLE CLAMP		
09E 8 x 1 / 1 x 2		09G 6 x 1 / 3 x 2		09J 9 x 1		12T 12 x 1		12V 12 x 1 (code 20°)		16A 16 x 1		17G 17 x 1				
CONTACT ARRANGEMENTS VIEW MATING FACE																
09E	-	09G	-	09J	-	12T	-	12V	-	16A	-	17G	-	000		
	-		-		-		-		-		-		-		-	
	MRSR		MRSR		-		-		-		-		-		-	
	MRSV		MRSV		-		-		-		-		-		-	
	MRWR		MRWR		-		-		-		-		-		-	
	MRWV		MRWV		-		-		-		-		-		-	
	-		-		MRSN		MRSN		MRSN		MRSN		MRSN		MRSN	
	-		-		MRWN		MRWN		MRWN		MRWN		MRWN		MRWN	
09E	-	09G	-	09J	-	12T	-	12V	-	16A	-	17G	-		000	
	-		-		-		-		-		-		-			-
	FROR		FROR		-		-		-		-		-			-
	FROM		FROM		-		-		-		-		-			-
	FRBR		FRBR		-		-		-		-		-			-
	FRBM		FRBM		-		-		-		-		-			-
	-		-		FRON		FRON		FRON		FRON		FRON	FRON		
	-		-		FRBN		FRBN		FRBN		FRBN		FRBN	FRBN		
09E	NNNN	09G	NNNN	09J	NNNN	12T	NNNN	12V	NNNN	16A	NNNN	17G	NNNN	NNNN		
	-		-		NNNN		NNNN		NNNN		NNNN		NNNN			

Signal receptacles for crimp contacts 6 - 17way

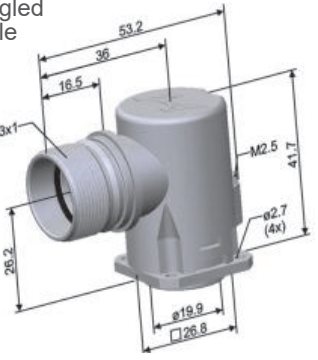
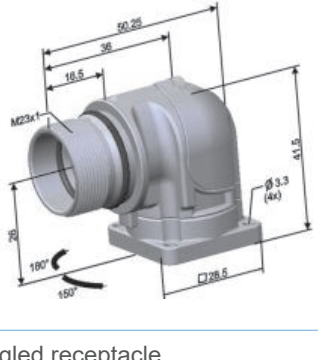
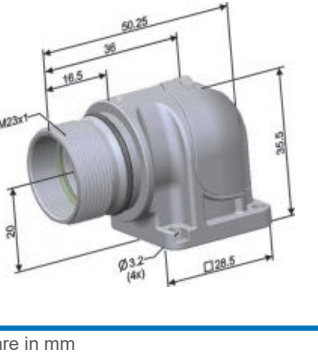





LAYOUT DESCRIPTION PART NUMBER CONFIGURATOR		SHELL	CONTACT STYLE GENDER REVERSIBLE		 06G 6 x 2	 07C 7 x 2
			CONTACT ARRANGEMENTS VIEW MATING FACE			
			TERMINATION CROSS SECTION			
Rotatable angled receptacle		SFMB*	MACHINED CRIMP PINS	AWG 18-14	MRRN	MRRN
		AWG 22-16		MRVN	MRVN	
		AWG 24-18, 18-14		-	-	
		AWG 24-18, 22-16		-	-	
		AWG 30-22, 18-14		-	-	
		AWG 30-22, 22-16		-	-	
		AWG 24-18		-	-	
		AWG 30-22		-	-	
Fixed angled receptacle		SFYB*	MACHINED CRIMP SOCKETS	AWG 20-16	FRRN	FRRN
		AWG 18-14		FRMN	FRMN	
		AWG 24-18, 20-16		-	-	
		AWG 24-18, 18-14		-	-	
		AWG 30-22, 20-16		-	-	
		AWG 30-22, 18-14		-	-	
		AWG 24-18		-	-	
		AWG 30-22		-	-	
Rotatable angled receptacle		SGDG*	MACHINED CONTACTS	CONTACTS TO BE ORDERED SEPARATELY ¹⁾		
				without contacts		
Fixed angled receptacle		SGFG*	STAMPED HCS™ CONTACTS	CONTACTS ON REELS TO BE ORDERED SEPARATELY ²⁾		
				without contacts		

Dimensions are in mm

* UL Version

Note:



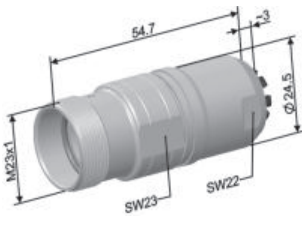
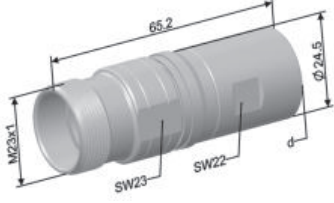
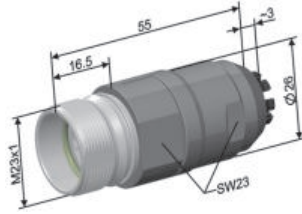

¹⁾ Machined contacts are shown on page 60-61, ²⁾ Stamped contacts are shown on page 62-63

														CABLE CLAMP
09E 8 x 1 / 1 x 2	09G 6 x 1 / 3 x 2	09J 9 x 1	12T 12 x 1	12V 12 x 1 (code 20°)	16A 16 x 1	17G 17 x 1	CONTACT ARRANGEMENTS VIEW MATING FACE							
09E	-	09G	-	09J	-	12T	-	12V	-	16A	-	17G	-	000
	-		-		-		-		-		-		-	
	MRSR		MRSR		-		-		-		-		-	
	MRSV		MRSV		-		-		-		-		-	
	MRWR		MRWR		-		-		-		-		-	
	MRWV		MRWV		-		-		-		-		-	
	-		-		MRSN		MRSN		MRSN		MRSN		MRSN	
	-		-		MRWN		MRWN		MRWN		MRWN		MRWN	
09E	-	09G	-	09J	-	12T	-	12V	-	16A	-	17G	-	000
	-		-		-		-		-		-		-	
	FROR		FROR		-		-		-		-		-	
	FROM		FROM		-		-		-		-		-	
	FRBR		FRBR		-		-		-		-		-	
	FRBM		FRBM		-		-		-		-		-	
	-		-		FRON		FRON		FRON		FRON		FRON	
	-		-		FRBN		FRBN		FRBN		FRBN		FRBN	
09E	NNNN	09G	NNNN	09J	NNNN	12T	NNNN	12V	NNNN	16A	NNNN	17G	NNNN	000
	-		-		NNNN		NNNN		NNNN		NNNN		NNNN	

Signal receptacles with solder contacts 6 - 12way

LAYOUT DESCRIPTION PART NUMBER CONFIGURATOR	SHELL	NUMBER OF CONTACTS	CONTACT ARRANGEMENTS VIEW MATING FACE			
			06C 6 x 2	06E 6 x 2		
		CONTACT STYLE				
Extension with cable clamp Ø 5.5-12 mm 	SRNA	PINS WITH SOLDER CUP	06C	MSBN	06E	MSBN
		SOCKETS WITH SOLDER CUP		FSBN		FSBN
Extension with cable clamp Ø 5.5-12 mm, threaded connection  d = SRRA = M20x1.5 SRGA = PG13.5	SRRA SRGA	PINS WITH SOLDER CUP	06C	MSBN	06E	MSBN
		SOCKETS WITH SOLDER CUP				
Extension, plastic shell, with cable clamp Ø 5.5-12 mm 	SROC	PINS WITH SOLDER CUP	06C	MSBN	06E	MSBN
		SOCKETS WITH SOLDER CUP				

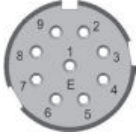
Dimensions are in mm

								CABLE CLAMP
<p>07A 7 x 2</p>		<p>09C 8 x 1 / 1 x 2</p>		<p>09A 9 x 1</p>		<p>12E 12 x 1</p>		
CONTACT ARRANGEMENTS VIEW MATING FACE								
07A	MSBN	09C	MSAB	09A	MSAN	12E	MSAN	169
	FSBN		FSAB		FSAN		FSAN	
07A	MSBN	09C	MSAB	09A	MSAN	12E	MSAN	000
	FSBN		FSAB		FSAN		FSAN	
07A	MSBN	09C	MSAB	09A	MSAN	12E	MSAN	169
	FSBN		FSAB		FSAN		FSAN	

Signal extensions with solder contacts 6 - 12way

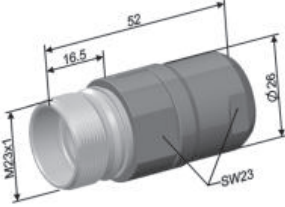
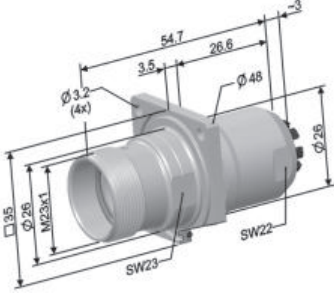
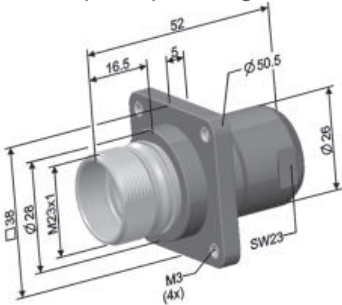
LAYOUT DESCRIPTION PART NUMBER CONFIGURATOR	SHELL	NUMBER OF CONTACTS	CONTACT ARRANGEMENTS VIEW MATING FACE		
		CONTACT STYLE	VIEW MATING FACE		
Extension, plastic shell, with cable specific cable clamps ¹⁾ 	SRUC	PINS WITH SOLDER CUP	06C	MSBN	MSBN
		SOCKETS WITH SOLDER CUP	06E	FSBN	FSBN
Extension with cable clamp Ø 5.5-12 mm, square flange 	SRNA	PINS WITH SOLDER CUP	06C	MSBN	MSBN
		SOCKETS WITH SOLDER CUP	06E	FSBN	FSBN
Extension, plastic shell, with cable specific cable clamps ¹⁾ , square flange 	SRWC	PINS WITH SOLDER CUP	06C	MSBN	MSBN
		SOCKETS WITH SOLDER CUP	06E	FSBN	FSBN

Dimensions are in mm

Note:

¹⁾ Cable specific cable clamp please contact factory

								CABLE CLAMP
<p>07A 7 x 2</p>		<p>09C 8 x 1 / 1 x 2</p>		<p>09A 9 x 1</p>		<p>12E 12 x 1</p>		
CONTACT ARRANGEMENTS VIEW MATING FACE								
07A	MSBN	09C	MSAB	09A	MSAN	12E	MSAN	...
	FSBN		FSAB		FSAN		FSAN	
07A	MSBN	09C	MSAB	09A	MSAN	12E	MSAN	16901
	FSBN		FSAB		FSAN		FSAN	
07A	MSBN	09C	MSAB	09A	MSAN	12E	MSAN	...
	FSBN		FSAB		FSAN		FSAN	

Signal extensions for crimp contacts 6 - 17way

LAYOUT DESCRIPTION PART NUMBER CONFIGURATOR	SHELL
Extension with cable clamp Ø 5.5-12 mm 	SRNA*
Extension with cable clamp Ø 5.5-12 mm, threaded connection <p>d = SRRA = M20x1.5 SRGA = PG13.5</p>	SRRA* SRGA*
Extension, plastic shell, with cable specific cable clamps ³⁾ 	SRUC*
Extension with cable clamp Ø 7.7-14.5 mm 	SRFA*







CONTACT STYLE GENDER REVERSIBLE	TERMINATION CROSS SECTION	CONTACT ARRANGEMENTS VIEW MATING FACE			
		06G 6 x 2		07C 7 x 2	
MACHINED CRIMP PINS	AWG 18-14	06G	MRRN	07C	MRRN
	AWG 22-16		MRVN		MRVN
	AWG 24-18, 18-14		-		-
	AWG 24-18, 22-16		-		-
	AWG 30-22, 18-14		-		-
	AWG 30-22, 22-16		-		-
	AWG 24-18		-		-
	AWG 30-22		-		-
MACHINED CRIMP SOCKETS	AWG 20-16	06G	FRRN	07C	FRRN
	AWG 18-14		FRMN		FRMN
	AWG 24-18, 20-16		-		-
	AWG 24-18, 18-14		-		-
	AWG 30-22, 20-16		-		-
	AWG 30-22, 18-14		-		-
	AWG 24-18		-		-
	AWG 30-22		-		-
MACHINED CONTACTS	CONTACTS TO BE ORDERED SEPARATELY ¹⁾ 	06G	NNNN	07C	NNNN
STAMPED HCS™ CONTACTS	CONTACTS ON REELS TO BE ORDERED SEPARATELY ²⁾ 		-		-

Dimensions are in mm

* UL Version

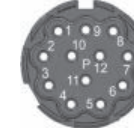
Note:

¹⁾ Machined contacts are shown on page 60-61, ²⁾ Stamped contacts are shown on page 62-63, ³⁾ Cable specific cable clamp please contact factory

 09E 8 x 1 / 1 x 2		 09G 6 x 1 / 3 x 2		 09J 9 x 1		 12T 12 x 1		 12V 12 x 1 (code 20°)		 16A 16 x 1		 17G 17 x 1		CABLE CLAMP	
CONTACT ARRANGEMENTS VIEW MATING FACE															
09E	-	09G	-	09J	-	12T	-	12V	-	16A	-	17G	-	169	
	-		-		-		-		-		-		-		-
	MRSR		MRSR		-		-		-		-		-		-
	MRSV		MRSV		-		-		-		-		-		-
	MRWR		MRWR		-		-		-		-		-		-
	MRWV		MRWV		-		-		-		-		-		-
	-		-		MRSN		MRSN		MRSN		MRSN		MRSN		MRSN
	-		-		MRWN		MRWN		MRWN		MRWN		MRWN		MRWN
09E	-	09G	-	09J	-	12T	-	12V	-	16A	-	17G	-	000	
	-		-		-		-		-		-		-		-
	FROR		FROR		-		-		-		-		-		-
	FROM		FROM		-		-		-		-		-		-
	FRBR		FRBR		-		-		-		-		-		-
	FRBM		FRBM		-		-		-		-		-		-
	-		-		FRON		FRON		FRON		FRON		FRON		FRON
	-		-		FRBN		FRBN		FRBN		FRBN		FRBN		FRBN
09E	NNNN	09G	NNNN	09J	NNNN	12T	NNNN	12V	NNNN	16A	NNNN	17G	NNNN	170	
	-		-		NNNN		NNNN		NNNN		NNNN		NNNN		

Signal extensions for crimp contacts 6 - 17way

LAYOUT DESCRIPTION PART NUMBER CONFIGURATOR	SHELL
Extension with cable clamp Ø 5.5-12 mm 	SROC*
Extension with cable clamp Ø 5.5-12 mm, square flange 	SRNA*
Extension, plastic shell, with cable specific cable clamps ³⁾ , square flange 	SRWC*
Extension with cable clamp Ø 5-16 mm 	SVRA*







Dimensions are in mm

* UL Version

CONTACT STYLE GENDER REVERSIBLE	TERMINATION CROSS SECTION	CONTACT ARRANGEMENTS VIEW MATING FACE			
		06G 6 x 2		07C 7 x 2	
MACHINED CRIMP PINS	AWG 18-14	06G	07C	MRRN	MRRN
	AWG 22-16			MRVN	MRVN
	AWG 24-18, 18-14			-	-
	AWG 24-18, 22-16			-	-
	AWG 30-22, 18-14			-	-
	AWG 30-22, 22-16			-	-
	AWG 24-18			-	-
	AWG 30-22			-	-
MACHINED CRIMP SOCKETS	AWG 20-16	06G	07C	FRRN	FRRN
	AWG 18-14			FRMN	FRMN
	AWG 24-18, 20-16			-	-
	AWG 24-18, 18-14			-	-
	AWG 30-22, 20-16			-	-
	AWG 30-22, 18-14			-	-
	AWG 24-18			-	-
AWG 30-22	-	-			
MACHINED CONTACTS	CONTACTS TO BE ORDERED SEPARATELY ¹⁾	06G	07C	NNNN	NNNN
without contacts	-			-	
STAMPED HCS™ CONTACTS	CONTACTS ON REELS TO BE ORDERED SEPARATELY ²⁾	06G	07C	-	-
without contacts	-			-	

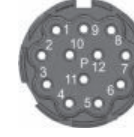
Note:

¹⁾ Machined contacts are shown on page 60-61, ²⁾ Stamped contacts are shown on page 62-63

														CABLE CLAMP
09E 8 x 1 / 1 x 2	09G 6 x 1 / 3 x 2	09J 9 x 1	12T 12 x 1	12V 12 x 1 (code 20°)	16A 16 x 1	17G 17 x 1	CONTACT ARRANGEMENTS VIEW MATING FACE							
09E	-	09G	-	09J	-	12T	-	12V	-	16A	-	17G	-	169
	-		-		-		-		-		-		-	
	MRSR		MRSR		-		-		-		-		-	
	MRSV		MRSV		-		-		-		-		-	
	MRWR		MRWR		-		-		-		-		-	
	MRWV		MRWV		-		-		-		-		-	
	-		-		MRSN		MRSN		MRSN		MRSN		MRSN	
-	-	MRWN	MRWN	MRWN	MRWN	MRWN	MRWN							
09E	-	09G	-	09J	-	12T	-	12V	-	16A	-	17G	-	16901
	-		-		-		-		-		-		-	
	FROR		FROR		-		-		-		-		-	
	FROM		FROM		-		-		-		-		-	
	FRBR		FRBR		-		-		-		-		-	
	FRBM		FRBM		-		-		-		-		-	
	-		-		FRON		FRON		FRON		FRON		FRON	
-	-	FRBN	FRBN	FRBN	FRBN	FRBN	FRBN							
09E	NNNN	09G	NNNN	09J	NNNN	12T	NNNN	12V	NNNN	16A	NNNN	17G	NNNN	260 261 262
	-		-		NNNN		NNNN		NNNN		NNNN		NNNN	

Note: ³⁾ Cable specific cable clamp please contact factory. ⁴⁾ More information please contact factory.



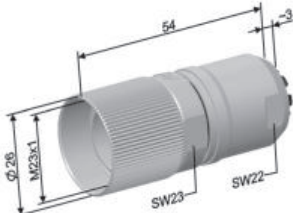
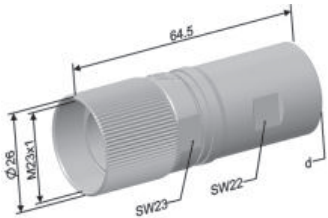
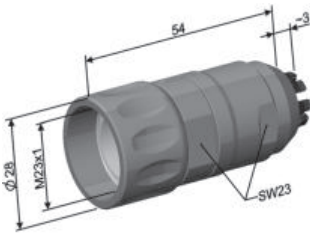
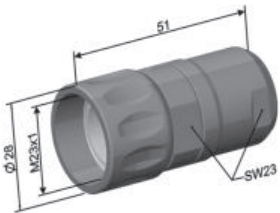

Signal plugs with solder contacts 6 - 12way

LAYOUT DESCRIPTION PART NUMBER CONFIGURATOR	SHELL	NUMBER OF CONTACTS	CONTACT ARRANGEMENTS VIEW MATING FACE			
		CONTACT STYLE	VIEW MATING FACE			
Plug with cable clamp Ø 5.5–12 mm 	SPNA	PINS WITH SOLDER CUP	06D	MSBN	06F	MSBN
		SOCKETS WITH SOLDER CUP		FSBN		FSBN
Plug with cable clamp Ø 5.5–12 mm, threaded connection  d = SPRA = M20x1.5 SPGA = PG13.5	SPRA SPGA	PINS WITH SOLDER CUP	06D	MSBN	06F	MSBN
		SOCKETS WITH SOLDER CUP		FSBN		FSBN
Plug, plastic shell, with cable clamp Ø 5.5–12 mm 	SPOC	PINS WITH SOLDER CUP	06D	MSBN	06F	MSBN
		SOCKETS WITH SOLDER CUP		FSBN		FSBN
Plug, plastic shell, with cable specific cable clamps ¹⁾ 	SPUC	PINS WITH SOLDER CUP	06D	MSBN	06F	MSBN
		SOCKETS WITH SOLDER CUP		FSBN		FSBN

Dimensions are in mm

Note:

¹⁾ Cable specific cable clamp please contact factory



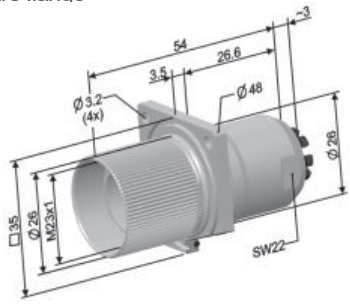
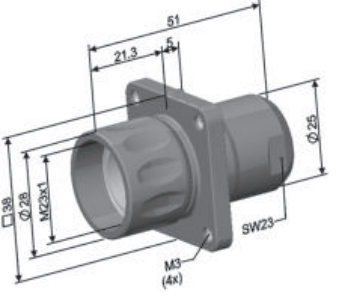
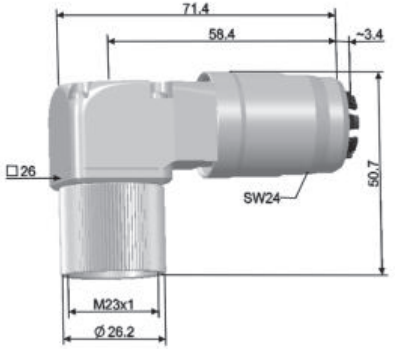

								CABLE CLAMP
<p>07B 7 x 2</p>		<p>09D 8 x 1 / 1 x 2</p>		<p>09B 9 x 1</p>		<p>12F 12 x 1</p>		
CONTACT ARRANGEMENTS VIEW MATING FACE								
07B	MSBN	09D	MSAB	09B	MSAN	12F	MSAN	169
	FSBN		FSAB		FSAN		FSAN	
07B	MSBN	09D	MSAB	09B	MSAN	12F	MSAN	000
	FSBN		FSAB		FSAN		FSAN	
07B	MSBN	09D	MSAB	09B	MSAN	12F	MSAN	169
	FSBN		FSAB		FSAN		FSAN	
07B	MSBN	09D	MSAB	09B	MSAN	12F	MSAN	...
	FSBN		FSAB		FSAN		FSAN	

Signal plugs with solder contacts 6 - 12way



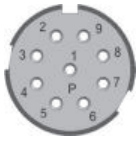

LAYOUT DESCRIPTION PART NUMBER CONFIGURATOR	SHELL	NUMBER OF CONTACTS	CONTACT ARRANGEMENTS VIEW MATING FACE		
			CONTACT STYLE		
Plug with with cable clamp \varnothing 5.5–12 mm, square flange 	SPNA	PINS WITH SOLDER CUP	06D	MSBN	MSBN
		SOCKETS WITH SOLDER CUP	06D	FSBN	FSBN
Plug, plastic shell, with cable specific cable clamps ¹⁾ , square flange 	SPYC	PINS WITH SOLDER CUP	06D	MSBN	MSBN
		SOCKETS WITH SOLDER CUP	06D	FSBN	FSBN
Angled plug with cable clamp \varnothing 7.7-14.5 mm 	SPHA	PINS WITH SOLDER CUP	06D	MSBN	MSBN
		SOCKETS WITH SOLDER CUP	06D	FSBN	FSBN

Dimensions are in mm

Note:
¹⁾ Cable specific cable clamp please contact factory

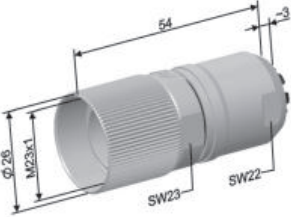
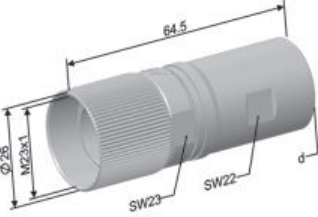
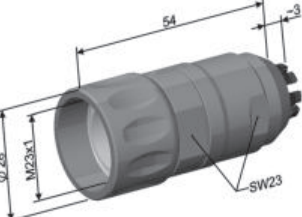
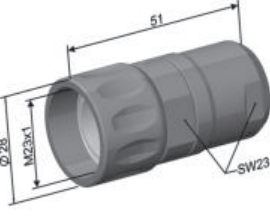
								CABLE CLAMP
<p>07B 7 x 2</p>		<p>09D 8 x 1 / 1 x 2</p>		<p>09B 9 x 1</p>		<p>12F 12 x 1</p>		
CONTACT ARRANGEMENTS VIEW MATING FACE								
07B	MSBN	09D	MSAB	09B	MSAN	12F	MSAN	16914
	FSBN		FSAB		FSAN		FSAN	
07B	MSBN	09D	MSAB	09B	MSAN	12F	MSAN	...
	FSBN		FSAB		FSAN		FSAN	
07B	MSBN	09D	MSAB	09B	MSAN	12F	MSAN	17003
	FSBN		FSAB		FSAN		FSAN	

Signal plugs for crimp contacts 6 - 17way







LAYOUT DESCRIPTION PART NUMBER CONFIGURATOR		SHELL	CONTACT STYLE GENDER REVERSIBLE		TERMINATION CROSS SECTION		CONTACT ARRANGEMENTS VIEW MATING FACE		
<p>Plug with cable clamp Ø 5.5-12 mm</p>  <p>SPNA*</p>	<p>Plug with cable clamp Ø 5.5-12 mm, threaded connection</p>  <p>SPRA* SPGA*</p>	<p>Plug, plastic shell, with cable clamp Ø 5.5-12 mm</p>  <p>SPOC*</p>	<p>Plug, plastic shell, with cable specific cable clamps³⁾</p>  <p>SPUC*</p>	 <p>06H 6 x 2</p>	 <p>07D 7 x 2</p>	<p>MACHINED CRIMP PINS</p>	<p>AWG 18-14</p>	MRRN	MRRN
AWG 22-16	MRVN	MRVN							
AWG 24-18, 18-14	-	-							
AWG 24-18, 22-16	-	-							
AWG 30-22, 18-14	-	-							
AWG 30-22, 22-16	-	-							
AWG 24-18	-	-							
AWG 30-22	-	-							
MACHINED CRIMP SOCKETS	AWG 20-16	FRRN	FRRN						
	AWG 18-14	FRMN	FRMN						
	AWG 24-18, 20-16	-	-						
	AWG 24-18, 18-14	-	-						
	AWG 30-22, 20-16	-	-						
	AWG 30-22, 18-14	-	-						
	AWG 24-18	-	-						
MACHINED CONTACTS	CONTACTS TO BE ORDERED SEPARATELY ¹⁾	NNNN	NNNN						
<p>without contacts</p> 									
<p>CONTACTS ON REELS TO BE ORDERED SEPARATELY²⁾</p> <p>without contacts</p> 									

Dimensions are in mm

* UL Version

Note:

¹⁾ Machined contacts are shown on page 60-61, ²⁾ Stamped contacts are shown on page 62-63, ³⁾ Cable specific cable clamp please contact factory

 09F 8 x 1 / 1 x 2		 09H 6 x 1 / 3 x 2		 09K 9 x 1		 12S 12 x 1		 12U 12 x 1 (code 20°)		 16B 16 x 1		 17H 17 x 1		CABLE CLAMP
CONTACT ARRANGEMENTS VIEW MATING FACE														
09F	-	09H	-	09K	-	12S	-	12U	-	16B	-	17H	-	169
	-		-		-		-		-		-		-	
	MRSR		MRSR		-		-		-		-		-	
	MRSV		MRSV		-		-		-		-		-	
	MRWR		MRWR		-		-		-		-		-	
	MRWV		MRWV		-		-		-		-		-	
	-		-		MRSN		MRSN		MRSN		MRSN		MRSN	
-	-	MRWN	MRWN	MRWN	MRWN	MRWN								
09F	-	09H	-	09K	-	12S	-	12U	-	16B	-	17H	-	000
	-		-		-		-		-		-		-	
	FROR		FROR		-		-		-		-		-	
	FROM		FROM		-		-		-		-		-	
	FRBR		FRBR		-		-		-		-		-	
	FRBM		FRBM		-		-		-		-		-	
	-		-		FRON		FRON		FRON		FRON		FRON	
-	-	FRBN	FRBN	FRBN	FRBN	FRBN								
09F	NNNN	09H	NNNN	09K	NNNN	12S	NNNN	12U	NNNN	16B	NNNN	17H	NNNN	169
	-		-		NNNN		NNNN		NNNN		NNNN		NNNN	

Signal plugs for crimp contacts 6 - 17way

LAYOUT DESCRIPTION PART NUMBER CONFIGURATOR

SHELL

Plug with cable clamp Ø 5.5-12 mm, square flange

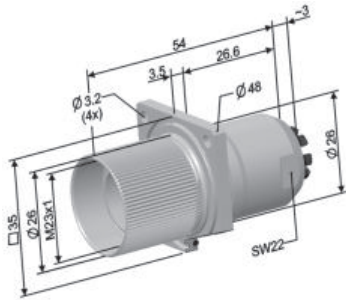

SPNA*

Plug, plastic shell, with cable specific cable clamps¹⁾, square flange

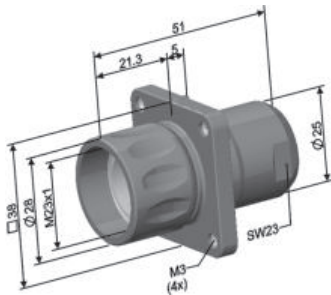

SPYC*

Angled plug with cable clamp Ø 7.7-14.5 mm

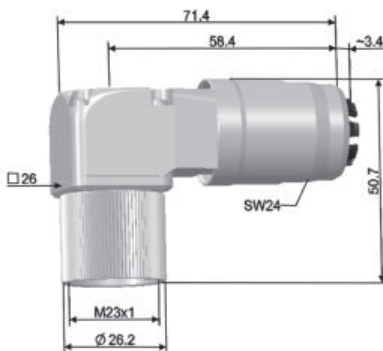

SPHA*

Dimensions are in mm

* UL Version

CONTACT STYLE GENDER REVERSIBLE	TERMINATION CROSS SECTION	CONTACT ARRANGEMENTS VIEW MATING FACE		
		06H 6 x 2	07D 7 x 2	
MACHINED CRIMP PINS	AWG 18-14	06H	MRRN	MRRN
	AWG 22-16		MRVN	MRVN
	AWG 24-18, 18-14		-	-
	AWG 24-18, 22-16		-	-
	AWG 30-22, 18-14		-	-
	AWG 30-22, 22-16		-	-
	AWG 24-18		-	-
	AWG 30-22		-	-
MACHINED CRIMP SOCKETS	AWG 20-16	06H	FRRN	FRRN
	AWG 18-14		FRMN	FRMN
	AWG 24-18, 20-16		-	-
	AWG 24-18, 18-14		-	-
	AWG 30-22, 20-16		-	-
	AWG 30-22, 18-14		-	-
	AWG 24-18		-	-
	AWG 30-22		-	-
MACHINED CONTACTS	CONTACTS TO BE ORDERED SEPARATELY ¹⁾ without contacts	06H	NNNN	NNNN
STAMPED HCS™ CONTACTS	CONTACTS ON REELS TO BE ORDERED SEPARATELY ²⁾ without contacts		07D	-

Note:

¹⁾ Machined contacts are shown on page 60-61, ²⁾ Stamped contacts are shown on page 62-63, ³⁾ Cable specific cable clamp please contact factory



09F
8 x 1 / 1 x 2



09H
6 x 1 / 3 x 2



09K
9 x 1

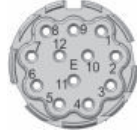

12S
12 x 1



12U
12 x 1 (code 20°)



16B
16 x 1



17H
17 x 1

CONTACT ARRANGEMENTS VIEW MATING FACE

09F	-	09H	-	09K	-	12S	-	12U	-	16B	-	17H	-	
	-		-		-		-		-		-		-	-
	MRSR		MRSR		-		-		-		-		-	-
	MRSV		MRSV		-		-		-		-		-	-
	MRWR		MRWR		-		-		-		-		-	-
	MRWV		MRWV		-		-		-		-		-	-
	-		-		MRSN		MRSN		MRSN		MRSN		MRSN	MRSN
	-		-		MRWN		MRWN		MRWN		MRWN		MRWN	MRWN
09F	-	09H	-	09K	-	12S	-	12U	-	16B	-	17H	-	
	-		-		-		-		-		-		-	-
	FROR		FROR		-		-		-		-		-	-
	FROM		FROM		-		-		-		-		-	-
	FRBR		FRBR		-		-		-		-		-	-
	FRBM		FRBM		-		-		-		-		-	-
	-		-		FRON		FRON		FRON		FRON		FRON	FRON
	-		-		FRBN		FRBN		FRBN		FRBN		FRBN	FRBN
09F	NNNN	09H	NNNN	09K	NNNN	12S	NNNN	12U	NNNN	16B	NNNN	17H	NNNN	
	-		-		NNNN		NNNN		NNNN		NNNN		NNNN	

CABLE CLAMP

16914

...

17003

Signal plugs for crimp contacts 6 - 17way

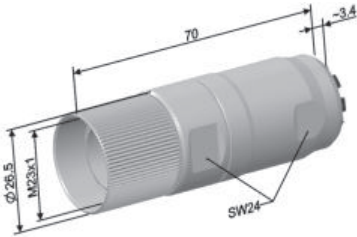
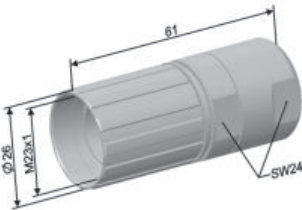
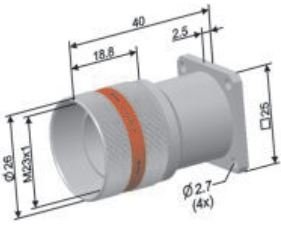
LAYOUT DESCRIPTION PART NUMBER CONFIGURATOR	SHELL
Plug with cable clamp Ø 7.7-14.5 mm 	SPFA*
Plug with cable clamp Ø 5-16 mm 	SVPA*
Flange can be ordered separately ³⁾ Panel feed through, square flange 	SDPA*







Dimensions are in mm

* UL Version

CONTACT STYLE GENDER REVERSIBLE	TERMINATION CROSS SECTION	CONTACT ARRANGEMENTS VIEW MATING FACE			
		06H 6 x 2		07D 7 x 2	
MACHINED CRIMP PINS	AWG 18-14	06H	MRRN	07D	MRRN
	AWG 22-16		MRVN		MRVN
	AWG 24-18, 18-14		-		-
	AWG 24-18, 22-16		-		-
	AWG 30-22, 18-14		-		-
	AWG 30-22, 22-16		-		-
	AWG 24-18		-		-
	AWG 30-22		-		-
MACHINED CRIMP SOCKETS	AWG 20-16	06H	FRRN	07D	FRRN
	AWG 18-14		FRMN		FRMN
	AWG 24-18, 20-16		-		-
	AWG 24-18, 18-14		-		-
	AWG 30-22, 20-16		-		-
	AWG 30-22, 18-14		-		-
	AWG 24-18		-		-
	AWG 30-22		-		-
MACHINED CONTACTS	CONTACTS TO BE ORDERED SEPARATELY ¹⁾ without contacts	06H	NNNN	07D	NNNN
STAMPED HCS™ CONTACTS	CONTACTS ON REELS TO BE ORDERED SEPARATELY ²⁾ without contacts		-		-

Note:

¹⁾ Machined contacts are shown on page 60-61, ²⁾ Stamped contacts are shown on page 62-63, ³⁾ More information please contact factory.

 09F 8 x 1 / 1 x		 09H 6 x 1 / 3 x 2		 09K 9 x 1		 12S 12 x 1		 12U 12 x 1 (code 20°)		 16B 16 x 1		 17H 17 x 1		CABLE CLAMP		
CONTACT ARRANGEMENTS VIEW MATING FACE																
09F	-	09H	-	09K	-	12S	-	12U	-	16B	-	17H	-	170		
	-		-		-		-		-		-		-		-	
	MRSR		MRSR		-		-		-		-		-		-	
	MRSV		MRSV		-		-		-		-		-		-	
	MRWR		MRWR		-		-		-		-		-		-	
	MRWV		MRWV		-		-		-		-		-		-	
	-		-		MRSN		MRSN		MRSN		MRSN		MRSN		MRSN	
	-		-		MRWN		MRWN		MRWN		MRWN		MRWN		MRWN	
09F	-	09H	-	09K	-	12S	-	12U	-	16B	-	17H	-		260 261 262	
	-		-		-		-		-		-		-			-
	FROR		FROR		-		-		-		-		-			-
	FROM		FROM		-		-		-		-		-			-
	FRBR		FRBR		-		-		-		-		-			-
	FRBM		FRBM		-		-		-		-		-			-
	-		-		FRON		FRON		FRON		FRON		FRON			FRON
	-		-		FRBN		FRBN		FRBN		FRBN		FRBN			FRBN
09F	NNNN	09H	NNNN	09K	NNNN	12S	NNNN	12U	NNNN	16B	NNNN	17H	NNNN			000
	-		-		NNNN		NNNN		NNNN		NNNN		NNNN			

21 Pin Connectors

M23 Signal Connector Series S

Receptacle for 21 pin inserts

LAYOUT DESCRIPTION PART NUMBER CONFIGURATOR	SHELL	CONTACT STYLE	TERMINATION CROSS SECTION	VIEW MATING FACE		CABLE CLAMP
				21A 21 x 0.6		
Straight receptacle 	SFOA	MACHINED CRIMP PINS	AWG 26-22	21A	MRGN	000
		MACHINED CRIMP SOCKETS	AWG 26-22		FRFN	
		CONTACTS TO BE ORDERED SEPARATELY ¹⁾	without contacts		NNNN	

Dimensions are in mm

Note:

¹⁾ Machined contacts are shown on page 60-61

Extensions for 21 pin inserts

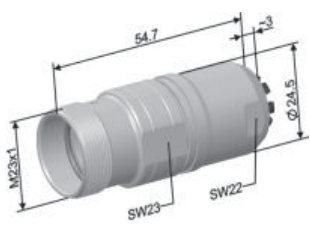
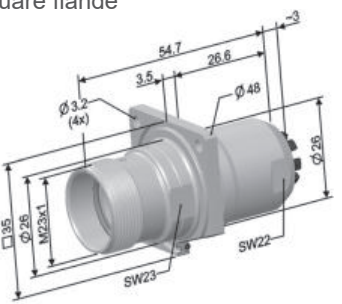
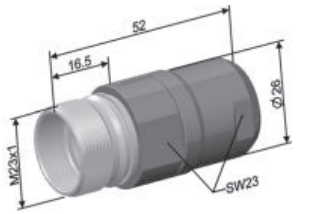
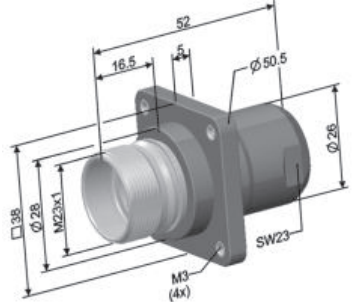
LAYOUT DESCRIPTION PART NUMBER CONFIGURATOR	SHELL	CONTACT STYLE	TERMINATION CROSS SECTION	21A 21 x 0.6		CABLE CLAMP
				VIEW MATING FACE		
Extension with cable clamp Ø 5.5-12 mm, 	SRNA	MACHINED CRIMP PINS	AWG 26-22	21A	MRGN	16913
		MACHINED CRIMP SOCKETS	AWG 26-22		FRFN	
		CONTACTS TO BE ORDERED SEPARATELY ¹⁾	without contacts		NNNN	
Extension with cable clamp Ø 5.5-12 mm, square flange 	SRNA	MACHINED CRIMP PINS	AWG 26-22	21A	MRGN	16912
		MACHINED CRIMP SOCKETS	AWG 26-22		FRFN	
		CONTACTS TO BE ORDERED SEPARATELY ¹⁾	without contacts		NNNN	
Extension plastic shell, with cable specific cable clamps ²⁾ 	SRUC	MACHINED CRIMP PINS	AWG 26-22	21A	MRGN	... 09
		MACHINED CRIMP SOCKETS	AWG 26-22		FRFN	
		CONTACTS TO BE ORDERED SEPARATELY ¹⁾	without contacts		NNNN	
Plug, plastic shell, with cable specific cable clamps ²⁾ , square flange 	SRWC	MACHINED CRIMP PINS	AWG 26-22	21A	MRGN	... 04
		MACHINED CRIMP SOCKETS	AWG 26-22		FRFN	
		CONTACTS TO BE ORDERED SEPARATELY ¹⁾	without contacts		NNNN	

Dimensions are in mm

Note:

¹⁾ Machined contacts are shown on page 60-61, ²⁾ Cable specific cable clamp please contact factory

Plugs for 21 pin inserts

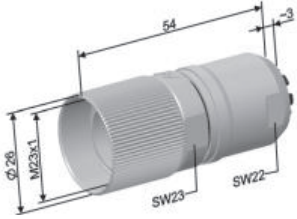
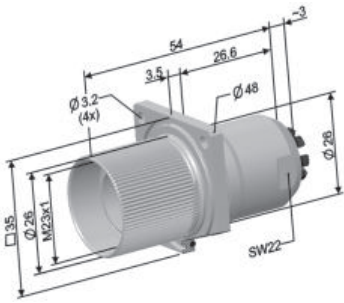
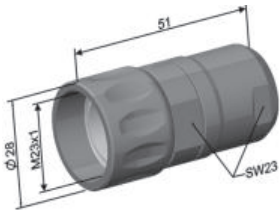
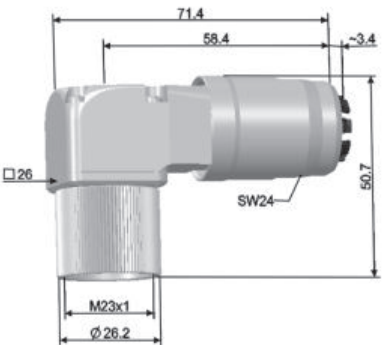
LAYOUT DESCRIPTION PART NUMBER CONFIGURATOR	SHELL	CONTACT STYLE	TERMINATION CROSS SECTION	21B 21 x 0.6		CABLE CLAMP
				VIEW MATING FACE		
Plug with cable clamp Ø 5.5-12 mm 	SPNA	MACHINED CRIMP PINS	AWG 26-22	21B	MRGN	16928
		MACHINED CRIMP SOCKETS	AWG 26-22		FRFN	
		CONTACTS TO BE ORDERED SEPARATELY ¹⁾	without contacts		NNNN	
Plug with cable clamp Ø 5.5-12 mm, square flange 	SPNA	MACHINED CRIMP PINS	AWG 26-22	21B	MRGN	16946
		MACHINED CRIMP SOCKETS	AWG 26-22		FRFN	
		CONTACTS TO BE ORDERED SEPARATELY ¹⁾	without contacts		NNNN	
Plug, plastic shell, with cable specific cable clamps ²⁾ 	SPUC	MACHINED CRIMP PINS	AWG 26-22	21B	MRGN	... 12
		MACHINED CRIMP SOCKETS	AWG 26-22		FRFN	
		CONTACTS TO BE ORDERED SEPARATELY ¹⁾	without contacts		NNNN	
Angled plug with cable clamp Ø 7.7-14.5 mm 	SPHA	MACHINED CRIMP PINS	AWG 26-22	21B	MRGN	17008
		MACHINED CRIMP SOCKETS	AWG 26-22		FRFN	
		CONTACTS TO BE ORDERED SEPARATELY ¹⁾	without contacts		NNNN	

Dimensions are in mm







Note:

¹⁾ Machined contacts are shown on page 60-61

²⁾ Customized cable clamp please contact factory

Cable Clamps & Accessories





M23 Signal Connector Series S

Cable clamp no. 169	Clamp range	
	<p>With reducing sleeve from 5.5 – 8.5 mm Without reducing sleeve from 8 – 12 mm Can be used for shielded and non-shielded cables</p>	
Cable clamp no. 170	Clamp range	
	<p>With reducing sleeve from 7.7 – 12 mm Without reducing sleeve from 11 – 14.5 mm Can be used for shielded and non-shielded cables</p>	
Cable clamp no. 260/261/262 for SVPA/SVRA	Clamp range	
	<p>.260 cable diameter 5 – 9 mm .261 cable diameter 9 – 15 mm .262 cable diameter 16mm Can be used for shielded and non-shielded cables</p>	
Thread protection cap	Part number	
	<p>031.001053.1000</p>	
Dust shield caps	Part number	Description
	<p>C/BEL/1</p>	<p>Dust shield cap for extension and receptacle</p>
	<p>C/BEL/7</p>	<p>Dust shield cap for extension and receptacle with chain 125 mm</p>
	<p>C/BEL/5</p>	<p>Dust shield cap for plug with chain 125 mm</p>





Contacts

M23 Signal Connector Series S

Machined pins - Series S



Type		R	V	S	W	G
Contact diameter [mm]		2	2	1	1	0.6
PART NUMBER AND LAYOUT		 021.310.1020	 021.356.1020	 021.311.1020	 021.402.1020	 021.072.1020
Termination cross section ¹⁾	[AWG] [mm ²]	18 – 14 0.75 – 2.5	22 – 16 0.34 – 1.5	24 – 18 0.24 – 1.0	30 – 22 0.05 – 0.34	26 – 22 0.14 – 0.34
Nominal current @ 20°C [A] ²⁾	VDE USR CNR	20 20 -	20 20 -	9 9 -	9 - -	3 - -
Crimping tool		B179	B151	B150	B150	B150
Positioner		B201	B201	B055/A	B055/A	B378

Hypertac® sockets - Series S

Type		R	M	O	B	F
Contact diameter [mm]		2	2	1	1	0.6
PART NUMBER AND LAYOUT		 020.315.1020	 020.263.1020	 020.256.1020	 020.353.1020	 020.060.1020
Termination cross section ¹⁾	[AWG] [mm ²]	20 - 16 0.5 - 1.5	18 - 14 0.75 - 2.5	24 - 18 0.24 - 1.0	30 - 22 0.05 - 0.34	26 - 22 0.14 - 0.34
Nominal current @ 20°C [A]	VDE USR CNR	20 20 -	20 20 -	9 9 -	9 9 -	3 - -
Crimping tool		B151	B151	B150	B150	B151
Positioner		B201	B201	B055/A	B055/A	B378

Note:
¹⁾ Mentioned crimp ranges are recommendations and only valid with flexible wires H05(07)V-K [mm²] acc. to DIN VDE 0281/0282 pp and with non compressed standard cables and wires acc. to DIN VDE 0295. It is possible that due to another structure of wired further cross sections and currents can be processed. ²⁾ data only valid when plugged with Hypertac sockets.

Machined pins - Series S (for receptacles IP67 unmated)

Type		A	E	M
Contact diameter [mm]		1	1	1
PART NUMBER AND LAYOUT		021.029.1020 	021.129.1020 	021.165.1020 
Termination cross section ¹⁾	[AWG] [mm ²]	26 - 22 0.14 - 0.34	24 - 18 0.24 - 1.0	24 - 18 0.24 - 1.0
Nominal current @ 20°C [A] ²⁾	VDE	9	9	9
	USR	8	8	8
	CNR	7	7	7
Crimping tool		B150	B150	B150
Positioner		B055/A	B055/A	B055/A

Note:

¹⁾ Mentioned crimp ranges are recommendations and only valid with flexible wires H05(07)V-K [mm²] acc. to DIN VDE 0281/0282 pp and with non compressed standard cables and wires acc. to DIN VDE 0295. It is possible that due to another structure of wired further cross sections and currents can be processed. ²⁾ data only valid when plugged with Hypertac sockets.

HCS™ Contacts

Stamped Hyperboloid Contacts on Reels

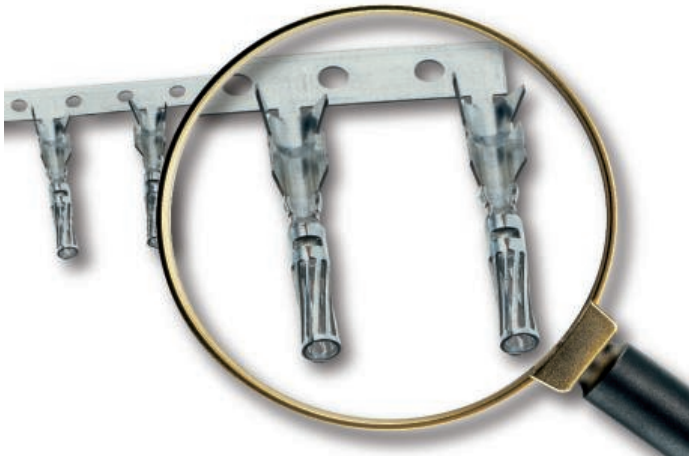

The HCS™ contact (Hyperboloid Contact Stamped) is the advanced evolution of the machined HYPERTAC® Hyperboloid Contact Technology that is ideal for higher volume applications requiring a fully automated process.

The demand for lower cost hyperboloid contacts led Smiths Connectors to the development of the stamped/rolled HCS contact, that is supplied on a reel and features an open crimp barrel design.

For all variations, the wire cage has the same design characteristics. In the contact area all single contact flaps are made in a circle shape which guarantees "wire quality". The HCS contacts on reels for crimping machines with automatic feeder lines are fully compatible with our machined Hypertac® hyperboloid contacts.

Vibration test acc. to DIN EN 60512/item4 35g X/Y/Z sinusoidal for 50h each without contact interrupts and without any change in contact resistance [$<5\text{m}\Omega$].

Smiths Connectors offers a full service for crimping tools:

- Applicators for all typical crimp devices
- Hand crimping tools for field installation

Electrical load HCS™ Ø 1 mm

Derating curve acc. DIN IEC 512/item3 (in air)

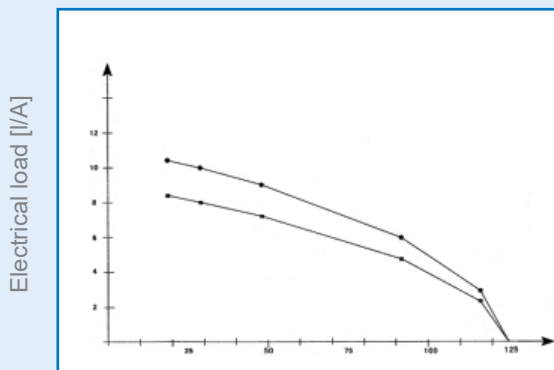

Environmental temperature [Te/°C]

Stamped Hyperboloid Contacts

Features & Benefits

- Favourable price
- Fully automatic processable
- Reduced assembly time
- High reliability wire B-crimp
- Additional insulation crimp
- Intermateable with machined round contacts

Specifications

Materials

Body: Tin-bronze

Plating: partly gold plated

Sleeve: stainless steel (sockets)

Crimp Geometry

Wire crimp: B-Crimp

Insulation crimp: O-Crimp

Mechanical

Operating Temperature: -40°C to 125°C

Insertion/extraction force: $<4\text{ N}$





Electrical

Contact resistance: $<5\text{ m}\Omega$





Note:

HCS™ is a registered Trademark of Smiths Interconnect

HCS™ stamped sockets - Series S

Type		A	B	C	D
Contact diameter [mm]		1	1	1	1
PART NUMBER AND LAYOUT		020.000376.2000 	020.000377.2000 	020.000378.2000 	020.000379.2000 
Termination cross section ¹⁾	AWG [mm ²]	32 – 28 0.03 – 0.08	28 – 24 0.08 – 0.2	24 – 20 0.2 – 0.5	0.75 – 1.0
Max. nominal current @ 20°C [A]	VDE USR CNR	4 9 -	6 9 -	8 9 -	8 9 -
Hand crimping tool with feeder line for small reels		B287/32-28	B287/28-24	B287/24-20	B287/0.75-1
Applicator for Schäfer/AMP crimping machine		B288/32-28	B288/28-24	B288/24-20	B288/0.75-1
Applicator for Kirsten PP3 crimping machine		B286/32-28	B286/28-24	B286/24-20	B286/0.75-1
Number of contacts on reel	[Pieces]	9000	9000	9000	9000
Number of contacts on small reel	[Pieces]	300	300	300	300

HCS™ stamped pins - Series S

Type		A	B	C	D
Contact diameter [mm]		1	1	1	1
PART NUMBER AND LAYOUT		021.001005.1025 	021.001006.1025 	021.001007.1025 	021.001008.1025 
Termination cross section ¹⁾	AWG [mm ²]	32 – 28 0.03 – 0.08	28 – 24 0.08 – 0.2	24 – 20 0.2 – 0.5	0.75 – 1.0
Max. nominal current @ 20°C [A]	VDE USR CNR	4 9 -	6 9 -	8 9 -	8 9 -
Hand crimping tool with feeder line for small reels		B287/32-28	B287/28-24	B287/24-20	B287/0.75-1
Applicator for Schäfer/AMP crimping machine		B288/32-28	B288/28-24	B288/24-20	B288/0.75-1
Applicator for Kirsten PP3 crimping machine		B286/32-28	B286/28-24	B286/24-20	B286/0.75-1
Number of contacts on reel	[Pieces]	9000	9000	9000	9000
Number of contacts on small reel	[Pieces]	300	300	300	300

Note:

¹⁾ Mentioned crimp ranges are recommendations and only valid with flexible wires H05(07)V-K [mm²] acc. to DIN VDE 0281/0282 pp and with not compressed standard cables and wires acc. to DIN VDE 0295. It is possible that due to another structure of wired further cross sections and currents can be processed.

Tools

Crimping tools for machined Contacts

Hand crimping tools	Part number
 <p>A hand crimping tool with blue handles and a blue body. It features a circular dial with numbers 1 through 7 and a 'SEL.' button. Text on the tool includes 'TO SET POSITIONER AND RAISE TO ROTATE', 'DMC-USA CAGE 11851', and 'NO.'.</p>	B150
 <p>A hand crimping tool with blue handles and a blue body. It features a circular dial with numbers 1 through 7 and a 'SEL.' button. Text on the tool includes 'DMC-USA CAGE 11851', 'RAISE TO ROTATE', and 'NO.'.</p>	B151
 <p>A hand crimping tool with black handles and a red body. It features a circular dial with numbers 1 through 7 and a 'SEL.' button. Text on the tool includes 'DMC-USA CAGE 11851', 'RAISE TO ROTATE', and 'NO.'.</p>	B179
Crimp accessories	Part number
 <p>A cylindrical metal gauge with a green handle and a red handle. It has 'CAGE 11851' and 'DMC-USA' printed on it.</p>	MASTER GAUGE B190 (for B150 and B151) B230 (for B179)
 <p>A cylindrical metal positioner with a red band.</p>	POSITIONER B154, B157, B165, B201, B245, B252, B297, B305, B306, B341, B378
 <p>A cylindrical metal positioner with a spring mechanism.</p>	POSITIONER B055/A

Crimping tools for stamped HCS™ contacts

Hand crimping tool with feeder line for small reels	Termination cross section	Part number
	Ø 1 mm CONTACTS 0.032–0.08 mm ² , AWG 32-28 0.08-0.20 mm ² , AWG 28-24 0.20-052 mm ² , AWG 24-20 0.75-1.00 mm ²	Ø 1 mm CONTACTS B287/32-28 B287/28-24 B287/24-20 B287/0.75-1
	Ø 2 mm CONTACTS 0.50-1.00 mm ² , AWG 20-18 1.00-2.00 mm ² , AWG 18-14	Ø 2 mm CONTACTS B295/0.5-1.0 B295/1.0-2.0

Hand crimping tool for discrete contacts	Termination cross section	Part number
	Ø 2 mm CONTACTS 2.50–4.00 mm ² , AWG12	Ø 2 mm CONTACTS B295/2.5-4

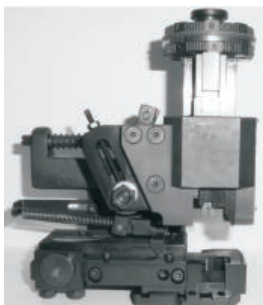
Applicators for crimping machines with feeder line	Termination cross section	Part number
Schäfer/AMP 	Ø 1 mm CONTACTS 0.032–0.08 mm ² , AWG 32-28 0.08-0.20 mm ² , AWG 28-24 0.20-052 mm ² , AWG 24-20 0.75-1.00 mm ²	Ø 1 mm CONTACTS B288/32-28 B288/28-24 B288/24-20 B288/0.75-1
	Ø 2 mm CONTACTS 0.50-1.00 mm ² , AWG 20-18 1.00-2.00 mm ² , AWG 18-14 2.50–4.00 mm ² , AWG12	Ø 2 mm CONTACTS on demand on demand on demand

Insertion and extraction tools

Insertion tools for insulators	Part number	Connector layout	Contact
	B091	Power LEAB	NA
	B116	Signal SDBA	NA
Insertion tools for contacts	Part number	Connector layout	Contact
	B117	Power Innovation: Plugs, Extensions, Receptacles, Panel Feed Through Power System 2000, Version 1i: Receptacles	Ø 2 mm
	B118	Power Innovation: Plugs, Extensions, Receptacles, Panel Feed Through Power System 2000, Version 1i: Receptacles Signal: Receptacles IP67	Ø 1 mm
	S/MONT/1/0060	Signal: Plugs, Receptacles, Extensions 21way	Ø 0.6 mm
Extraction tools for insulators	Part number	Connector layout	Contact
	B202	Signal: Receptacles with 2part insulators for crimp contacts	NA
	B116	Signal: Panel Feed Through with 2part insulator for crimp contacts, Receptacles with solder contacts	NA
	B186	Signal: Receptacles 21way	NA
Extraction tools for contacts	Part number	Connector layout	Contact
	B132		
	B037A (B132 + B037/10)	Power Innovation: Receptacles, Extensions, Power System 2000, Version 1i: Receptacles	Ø 2 mm
	B038A (B132 + B038/10)	Power Innovation: Receptacles, Extensions, Power System 2000, Version 1i: Receptacles Signal: Receptacles IP67	Ø 1 mm
	B056A (B132 + B056/10)	Power Innovation: Plugs, Panel Feed Through	Ø 1 mm
	S/DEM/6/0060	Signal: Plugs, Receptacles, Extensions 21way	Ø 0.6 mm

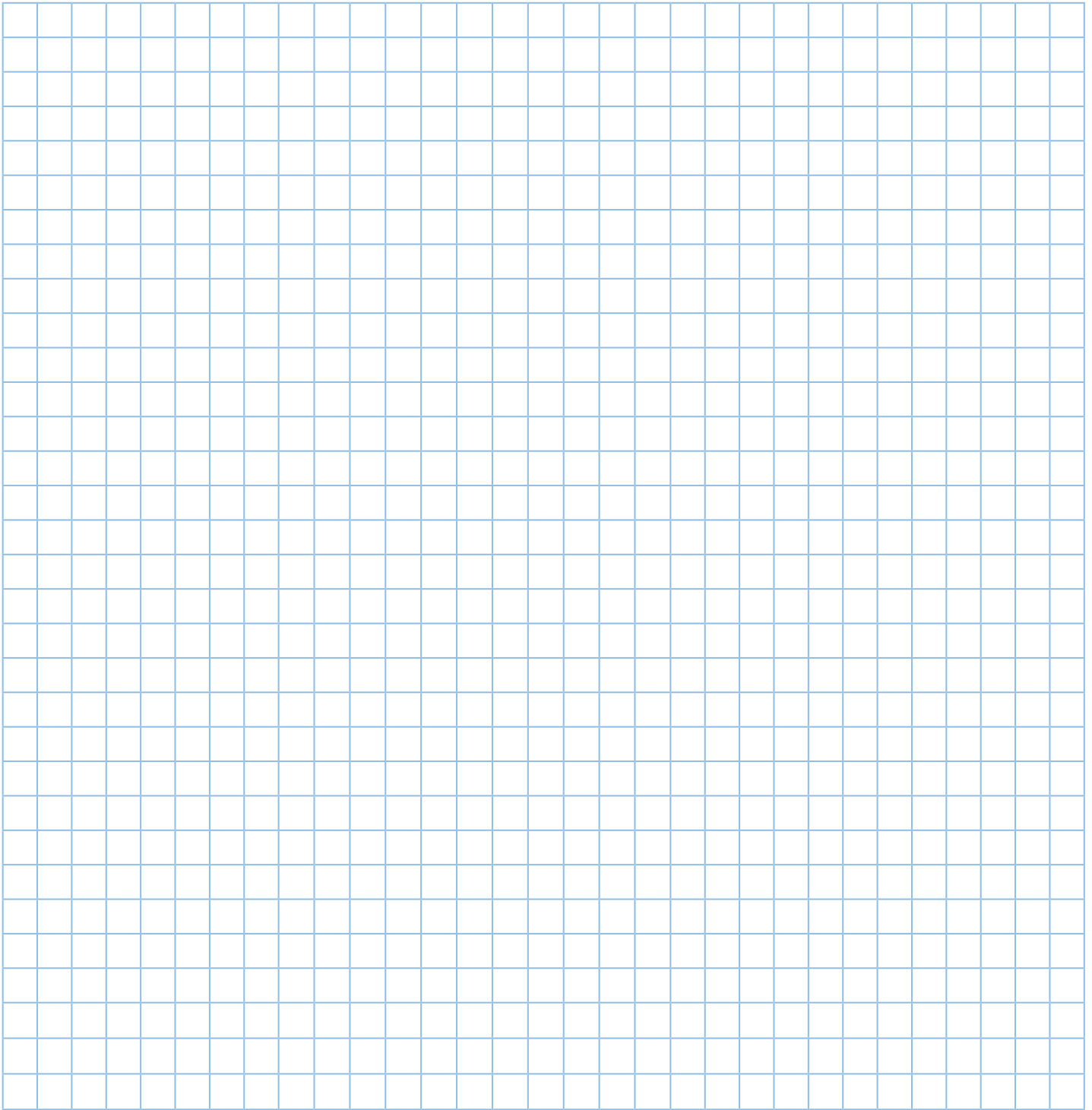

Notes:

Disclaimer 2023

All of the information included in this catalogue is believed to be accurate at the time of printing. It is recommended, however, that users should independently evaluate the suitability of each product for their intended application and be sure that each product is properly installed, used and maintained to achieve desired results.

Smiths Interconnect makes no warranties as to the accuracy or completeness of the information, and disclaims any liability regarding its use.

Smiths Interconnect reserves the right to modify design and specifications, in order to improve quality, keep pace with technological development or meet specific production requirements.

No reproduction or use without express permission of editorial and pictorial content, in any manner.

Product Portfolio

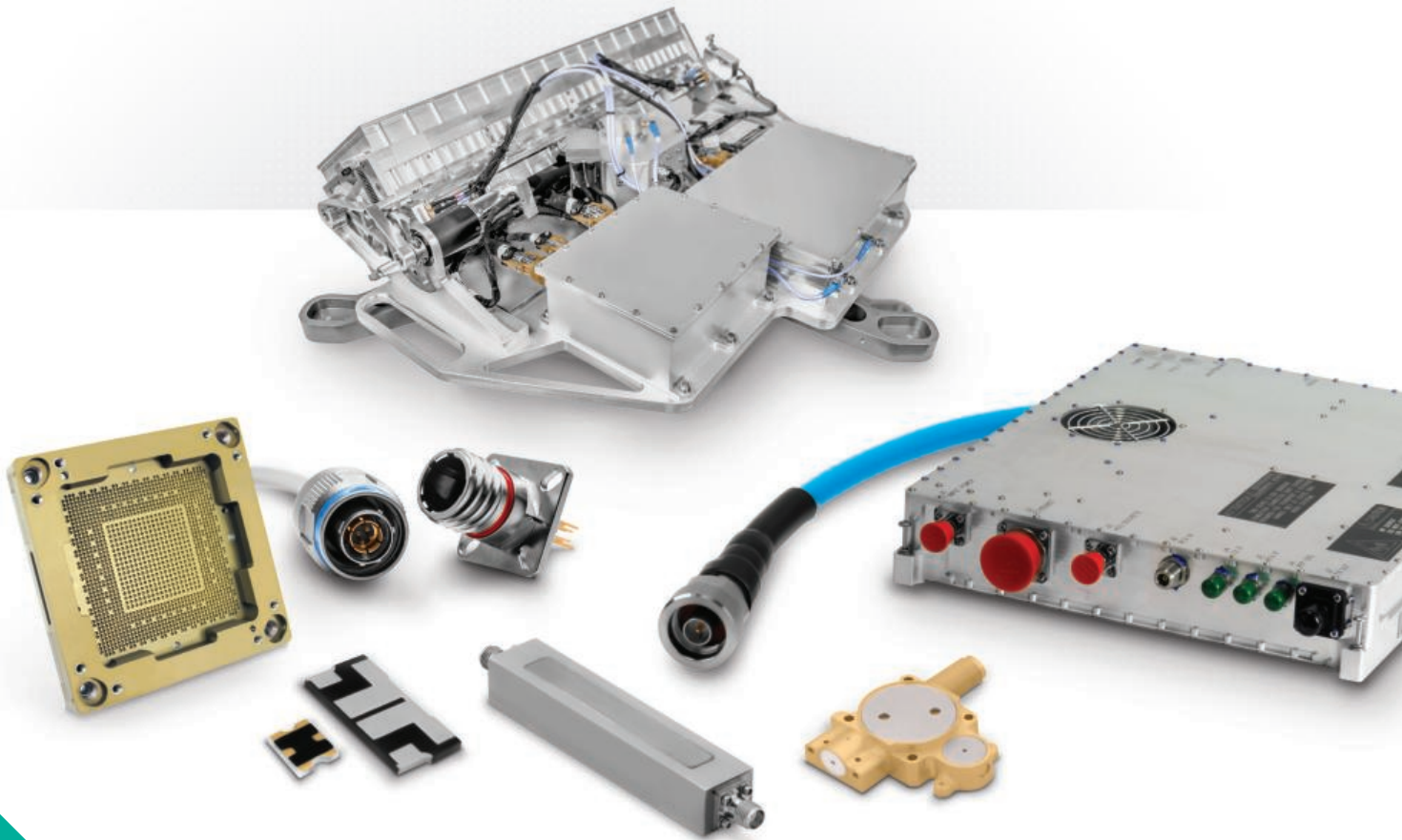

- Antenna Systems
 - Cable Assemblies
 - Connector Solutions
 - Ferrite Components & Assemblies
 - RF Filter Components & Assemblies
 - Integrated Microwave Assemblies
 - Millimeter-Wave Solutions
 - RF Components
 - Test Sockets and WLCSP Probe Heads
 - Time & Frequency Systems

Worldwide Support

Connectors

Americas

Sales

connectors.uscsr@smithsinterconnect.com

Technical Support

connectors.ustechsupport@smithsinterconnect.com

Europe

Sales

connectors.emeacsr@smithsinterconnect.com

Technical Support

connectors.emeatechsupport@smithsinterconnect.com

Asia

Sales

asiacsr@smithsinterconnect.com

Technical Support

asiatechsupport@smithsinterconnect.com

Fibre Optics & RF Components

Americas

Sales

focom.uscsr@smithsinterconnect.com

Technical Support

focom.techsupport@smithsinterconnect.com

Europe

Sales

focom.emeacsr@smithsinterconnect.com

Technical Support

focom.techsupport@smithsinterconnect.com

Asia

Sales

focom.asiacsr@smithsinterconnect.com

Technical Support

focom.techsupport@smithsinterconnect.com

Semiconductor Test

Americas

Sales

semi.uscsr@smithsinterconnect.com

Technical Support

semi.techsupport@smithsinterconnect.com

Europe

Sales

semi.emeacsr@smithsinterconnect.com

Technical Support

semi.techsupport@smithsinterconnect.com

Asia

Sales

semi.asiacsr@smithsinterconnect.com

Technical Support

semi.techsupport@smithsinterconnect.com

RF/MW Subsystems

Americas, Europe & Asia

Sales

subsystems.csr@smithsinterconnect.com

Technical Support

subsystems.techsupport@smithsinterconnect.com

Connecting Global Markets

more > [smithsinterconnect.com](https://www.smithsinterconnect.com) | [in](#) [twitter](#) [youtube](#)

Copyright© 2023 Smiths Interconnect | All rights reserved | Version 8.0

All of the information included in this catalogue is believed to be accurate at the time of printing.

The information contained within this document is subject at all times to applicable Export Control regulations and legal requirements.