



ECN/PCN No.: M1656

For Manufacturer			
<b>Product Description:</b> Low Profile Shielded SMD Chip Power Inductor	<b>Abracon Part Number / Part Series:</b> ASPI-5040S Series	<input type="checkbox"/> Documentation only <input type="checkbox"/> ECN <input checked="" type="checkbox"/> EOL	<input checked="" type="checkbox"/> Series <input type="checkbox"/> Part Number(s)
<b>Affected Revision:</b> C	<b>New Revision:</b> EOL	<b>Application:</b>	<input type="checkbox"/> Safety <input checked="" type="checkbox"/> Non-Safety
<b>Prior to Change:</b> Lifecycle status = Active			
<b>After Change:</b> Lifecycle status = EOL			
<b>Cause/Reason for Change:</b> As part of an effort to streamline our portfolio and better serve customers, we are discontinuing select products and offering a Last Time Buy period.			
Change Plan			
<b>Effective Date:</b> 11/27/2025	<b>Additional Remarks:</b>		
<b>Change Declaration:</b> Abracon products listed in this notice have been discontinued and are not recommended for new designs.			
<b>Issued Date:</b> 8/29/2025	<b>Issued By:</b> Ahmed Alamin	<b>Issued Department:</b> Engineering	
<b>Approval:</b> Syed Raza Engineering VP	<b>Approval:</b> Reuben Quintanilla Quality Director	<b>Approval:</b> Ying Huang Purchasing Director	
For Abracon EOL only			
<b>Last Time Buy (if applicable):</b> 2/25/2026	<b>Alternate Part Number / Part Series:</b> <a href="#">AMDHLH5030S</a> or <a href="#">AMDLA4530S</a>		
<b>Additional Approval:</b>	<b>Additional Approval:</b>	<b>Additional Approval:</b>	
Customer Approval (If Applicable)			
<b>Qualification Status:</b> <input type="checkbox"/> Approved <input type="checkbox"/> Not accepted <i>Note: It is considered approved if there is no feedback from the customer 1 month after ECN/PCN is released.</i>			
<b>Customer Part Number:</b>		<b>Customer Project:</b>	
<b>Company Name:</b>	<b>Company Representative:</b>	<b>Representative Signature:</b>	
<b>Customer Remarks:</b>			



# Low Profile Shielded SMD Chip Power Inductor

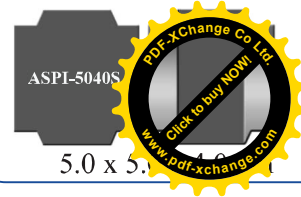

ASPI-5040S



RoHS  
Compliant

## FEATURES:

- Magnetically shielded for low radiation
- Large Terminal surface for good PCB mounting
- Low DCR and high rated current
- Suitable for DC-DC converter applications

## APPLICATIONS:

- Partable communication equipment
- OA equipment
- LCD, DVD, modem, set-top box
- DC/DC converters

## ELECTRICAL SPECIFICATIONS:

Part Number	Inductance	Tolerance	DCR Max	DCR Typ	Current Max	Temperature Rise Current Max
Units	$\mu\text{H}$	%	$\text{m}\Omega$	$\text{m}\Omega$	A	A
Symbol	L	M=±20%, N=±30%	DCR	DCR	Isat	Irms
ASPI-5040S-1R5	1.5	N	24	20	6.00	3.60
ASPI-5040S-2R2	2.2	N	26	22	4.60	3.50
ASPI-5040S-3R3	3.3	N	32	27	3.80	3.30
ASPI-5040S-4R7	4.7	N	35	29	3.30	3.10
ASPI-5040S-6R8	6.8	M	59	49	2.60	2.30
ASPI-5040S-100	10	M	67	56	2.30	2.10
ASPI-5040S-150	15	M	96	80	2.00	1.80
ASPI-5040S-220	22	M	151	126	1.60	1.40
ASPI-5040S-330	33	M	216	180	1.30	1.20
ASPI-5040S-470	47	M	372	310	1.10	0.90

### Test Criteria:

Inductance: 100kHz, 1V

Isat: Based on inductance change ( $\Delta L/L_0: \leq -30\%$ )

Irms: Based on temperature rise ( $\Delta T: 40^\circ\text{C TYP.}$ )

**Storage Temperature**  $-40^\circ\text{C} \sim 125^\circ\text{C}$  (including self-generated heat)

**Operating Temperature**  $-40^\circ\text{C} \sim 125^\circ\text{C}$

## OPTIONS AND PART IDENTIFICATION

ASPI-5040S - [ ] [ ] - [ ]

**Inductance Code**  
Please refer to the table above

**Tolerance**  
M: ±20%  
N: ±30%

**Packaging**  
T: Tape and Reel  
(1.5kpcs / reel)

M for  $6.8\mu\text{H} \sim 47\mu\text{H}$   
N for  $1.5\mu\text{H} \sim 4.7\mu\text{H}$



# Low Profile Shielded SMD Chip Power Inductor

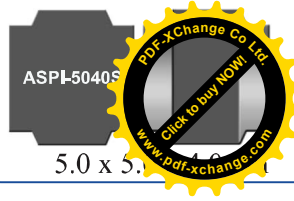

ASPI-5040S

**Pb** RoHS Compliant

5.0 x 5.0

## OUTLINE DRAWING:

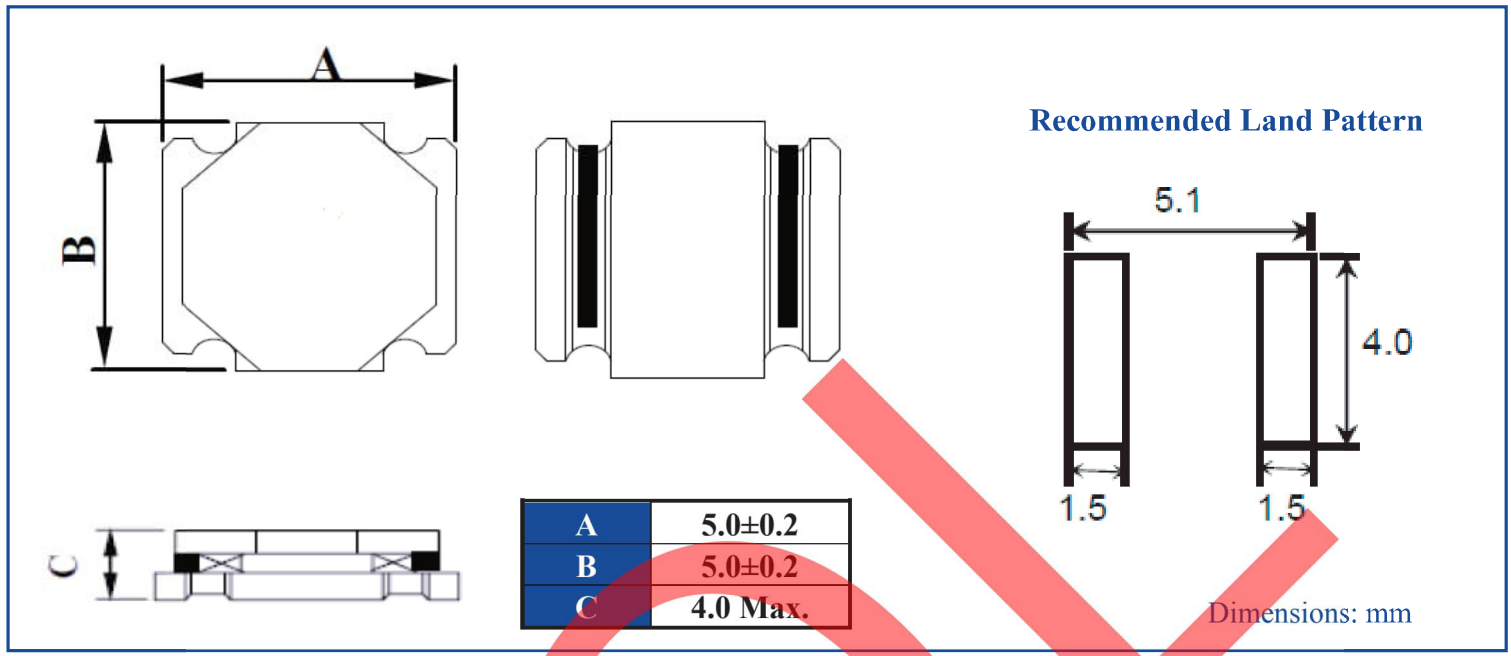

## REFLOW PROFILE

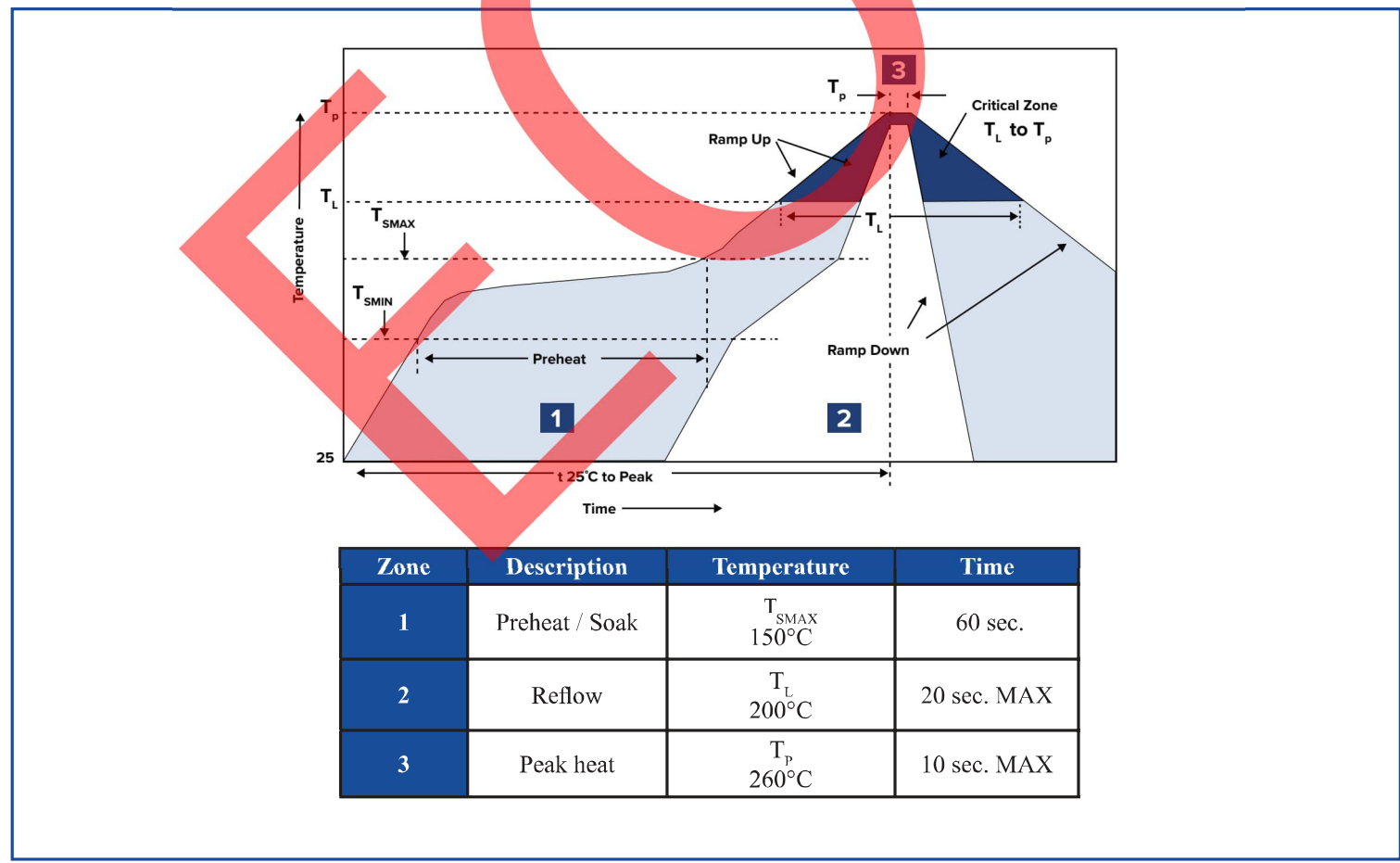



# Low Profile Shielded SMD Chip Power Inductor



ASPI-5040S

5.0 x 5.0



RoHS  
Compliant

ASPI-5040S

## TAPE & REEL: T: 1500pcs/reel

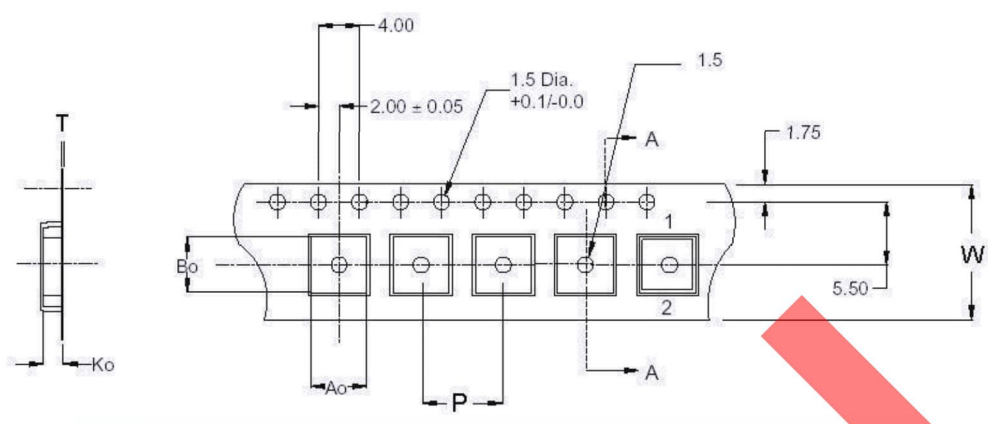

Ao	5.40
Bo	5.40
Ko	4.75
W	16.00
P	12.00
T	0.35

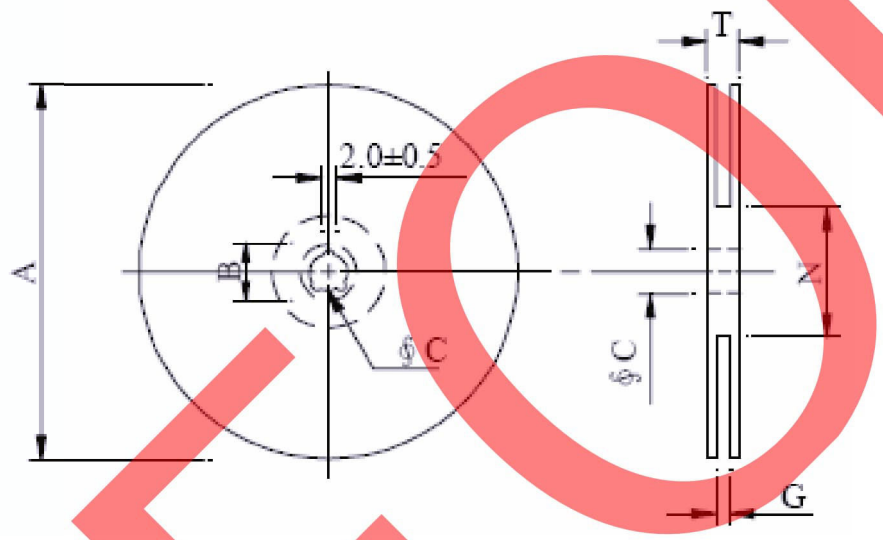

A	330
B	21.0±0.8
C	13.5±0.5
G	16.8
N	99.5
T	21.0

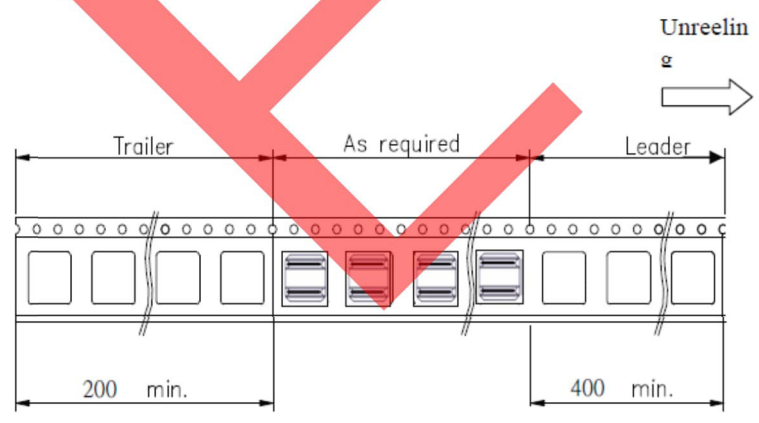

Dimensions: mm

**ATTENTION:** Abracon LLC's products are COTS – Commercial-Off-The-Shelf products; suitable for Commercial, Industrial and, where designated, Automotive Applications. Abracon's products are not specifically designed for Military, Aviation, Aerospace, Life-dependent Medical applications or any application requiring high reliability where component failure could result in loss of life and/or property. For applications requiring high reliability and/or presenting an extreme operating environment, written consent and authorization from Abracon LLC is required. Please contact Abracon LLC for more information.



5101 Hidden Creek Ln Spicewood TX 78669  
 Phone: 512-371-6159 | Fax: 512-351-8858  
 For terms and conditions of sales, please visit:  
[www.abracon.com](http://www.abracon.com)

REVISED: 12-02-19

ABRACON IS  
 ISO9001-2015  
 CERTIFIED









5049	<a href="https://abracon.com/downloads/ECN-PCN/7020-ECN-EOL-5049-FC6AS.pdf">https://abracon.com/downloads/ECN-PCN/7020-ECN-EOL-5049-FC6AS.pdf</a>	Fox	FC6AS	257-12-10	Active	EOL
5049	<a href="https://abracon.com/downloads/ECN-PCN/7020-ECN-EOL-5049-FC6AS.pdf">https://abracon.com/downloads/ECN-PCN/7020-ECN-EOL-5049-FC6AS.pdf</a>	Fox	FC6AS	FC6ASCBM16.0	Active	EOL
5049	<a href="https://abracon.com/downloads/ECN-PCN/7020-ECN-EOL-5049-FC6AS.pdf">https://abracon.com/downloads/ECN-PCN/7020-ECN-EOL-5049-FC6AS.pdf</a>	Fox	FC6AS	FC6ASBBKM14.7456	Active	EOL
5049	<a href="https://abracon.com/downloads/ECN-PCN/7020-ECN-EOL-5049-FC6AS.pdf">https://abracon.com/downloads/ECN-PCN/7020-ECN-EOL-5049-FC6AS.pdf</a>	Fox	FC6AS	FC6ASCCCL25.0	Active	EOL
5050	<a href="https://abracon.com/downloads/ECN-PCN/7020-ECN-EOL-5050-FC8AC.pdf">https://abracon.com/downloads/ECN-PCN/7020-ECN-EOL-5050-FC8AC.pdf</a>	Fox	FC8AC	217-3.6864-66	Active	EOL
5050	<a href="https://abracon.com/downloads/ECN-PCN/7020-ECN-EOL-5050-FC8AC.pdf">https://abracon.com/downloads/ECN-PCN/7020-ECN-EOL-5050-FC8AC.pdf</a>	Fox	FC8AC	217-3.6864-9	Active	EOL
5050	<a href="https://abracon.com/downloads/ECN-PCN/7020-ECN-EOL-5050-FC8AC.pdf">https://abracon.com/downloads/ECN-PCN/7020-ECN-EOL-5050-FC8AC.pdf</a>	Fox	FC8AC	217-4.194304-7	Active	EOL
5050	<a href="https://abracon.com/downloads/ECN-PCN/7020-ECN-EOL-5050-FC8AC.pdf">https://abracon.com/downloads/ECN-PCN/7020-ECN-EOL-5050-FC8AC.pdf</a>	Fox	FC8AC	FC8ACBBMD4.0-T1	Active	EOL
5050	<a href="https://abracon.com/downloads/ECN-PCN/7020-ECN-EOL-5050-FC8AC.pdf">https://abracon.com/downloads/ECN-PCN/7020-ECN-EOL-5050-FC8AC.pdf</a>	Fox	FC8AC	FC8ACBBPD6.0-T1	Active	EOL
5051	<a href="https://abracon.com/downloads/ECN-PCN/7020-ECN-EOL-5051-FC9SD.pdf">https://abracon.com/downloads/ECN-PCN/7020-ECN-EOL-5051-FC9SD.pdf</a>	Fox	FC9SD	FC9SDCBMF8.0-T1	Active	EOL
5051	<a href="https://abracon.com/downloads/ECN-PCN/7020-ECN-EOL-5051-FC9SD.pdf">https://abracon.com/downloads/ECN-PCN/7020-ECN-EOL-5051-FC9SD.pdf</a>	Fox	FC9SD	FC9SDCBMM8.0-T1	Active	EOL
5051	<a href="https://abracon.com/downloads/ECN-PCN/7020-ECN-EOL-5051-FC9SD.pdf">https://abracon.com/downloads/ECN-PCN/7020-ECN-EOL-5051-FC9SD.pdf</a>	Fox	FC9SD	FC9SDCCQM16.0	Active	EOL
5051	<a href="https://abracon.com/downloads/ECN-PCN/7020-ECN-EOL-5051-FC9SD.pdf">https://abracon.com/downloads/ECN-PCN/7020-ECN-EOL-5051-FC9SD.pdf</a>	Fox	FC9SD	FC9SDBBMF14.3594-T1	Active	EOL
5051	<a href="https://abracon.com/downloads/ECN-PCN/7020-ECN-EOL-5051-FC9SD.pdf">https://abracon.com/downloads/ECN-PCN/7020-ECN-EOL-5051-FC9SD.pdf</a>	Fox	FC9SD	280LF-20-20	Active	EOL
5051	<a href="https://abracon.com/downloads/ECN-PCN/7020-ECN-EOL-5051-FC9SD.pdf">https://abracon.com/downloads/ECN-PCN/7020-ECN-EOL-5051-FC9SD.pdf</a>	Fox	FC9SD	280LF-8-7	Active	EOL
5051	<a href="https://abracon.com/downloads/ECN-PCN/7020-ECN-EOL-5051-FC9SD.pdf">https://abracon.com/downloads/ECN-PCN/7020-ECN-EOL-5051-FC9SD.pdf</a>	Fox	FC9SD	FC9SDCBEF8.0-T1	Active	EOL
5052	<a href="https://abracon.com/downloads/ECN-PCN/7020-ECN-EOL-5052-FK13L.pdf">https://abracon.com/downloads/ECN-PCN/7020-ECN-EOL-5052-FK13L.pdf</a>	Fox	FK13L	FK13LEIBM0.032768-T3	Active	EOL
5052	<a href="https://abracon.com/downloads/ECN-PCN/7020-ECN-EOL-5052-FK13L.pdf">https://abracon.com/downloads/ECN-PCN/7020-ECN-EOL-5052-FK13L.pdf</a>	Fox	FK13L	FK13LEIHM0.032768-T3	Active	EOL
5052	<a href="https://abracon.com/downloads/ECN-PCN/7020-ECN-EOL-5052-FK13L.pdf">https://abracon.com/downloads/ECN-PCN/7020-ECN-EOL-5052-FK13L.pdf</a>	Fox	FK13L	FK13LEIVM0.032768-T3	Active	EOL
5052	<a href="https://abracon.com/downloads/ECN-PCN/7020-ECN-EOL-5052-FK13L.pdf">https://abracon.com/downloads/ECN-PCN/7020-ECN-EOL-5052-FK13L.pdf</a>	Fox	FK13L	FK13LEIHM0.032768	Active	EOL
5053	<a href="https://abracon.com/downloads/ECN-PCN/7020-ECN-EOL-5053-FK145.pdf">https://abracon.com/downloads/ECN-PCN/7020-ECN-EOL-5053-FK145.pdf</a>	Fox	FK145	FK145EIHMO.032768-T3	Active	EOL
5053	<a href="https://abracon.com/downloads/ECN-PCN/7020-ECN-EOL-5053-FK145.pdf">https://abracon.com/downloads/ECN-PCN/7020-ECN-EOL-5053-FK145.pdf</a>	Fox	FK145	FK145EIWM0.032768-T3	Active	EOL
5054	<a href="https://abracon.com/downloads/ECN-PCN/7020-ECN-EOL-5054-FKT26.pdf">https://abracon.com/downloads/ECN-PCN/7020-ECN-EOL-5054-FKT26.pdf</a>	Fox	FKT26	FKT26EIHQ0.032768	Active	EOL
5054	<a href="https://abracon.com/downloads/ECN-PCN/7020-ECN-EOL-5054-FKT26.pdf">https://abracon.com/downloads/ECN-PCN/7020-ECN-EOL-5054-FKT26.pdf</a>	Fox	FKT26	FKT26EIH00.032768	Active	EOL
5054	<a href="https://abracon.com/downloads/ECN-PCN/7020-ECN-EOL-5054-FKT26.pdf">https://abracon.com/downloads/ECN-PCN/7020-ECN-EOL-5054-FKT26.pdf</a>	Fox	FKT26	299LF-0.032768-5	Active	EOL
5054	<a href="https://abracon.com/downloads/ECN-PCN/7020-ECN-EOL-5054-FKT26.pdf">https://abracon.com/downloads/ECN-PCN/7020-ECN-EOL-5054-FKT26.pdf</a>	Fox	FKT26	299LF-0.032768-12	Active	EOL
5054	<a href="https://abracon.com/downloads/ECN-PCN/7020-ECN-EOL-5054-FKT26.pdf">https://abracon.com/downloads/ECN-PCN/7020-ECN-EOL-5054-FKT26.pdf</a>	Fox	FKT26	FKT26EIBM0.032768	Active	EOL
5054	<a href="https://abracon.com/downloads/ECN-PCN/7020-ECN-EOL-5054-FKT26.pdf">https://abracon.com/downloads/ECN-PCN/7020-ECN-EOL-5054-FKT26.pdf</a>	Fox	FKT26	FKT26EIHMO.032768	Active	EOL
5055	<a href="https://abracon.com/downloads/ECN-PCN/7020-ECN-EOL-5055-FKT38.pdf">https://abracon.com/downloads/ECN-PCN/7020-ECN-EOL-5055-FKT38.pdf</a>	Fox	FKT38	FKT38EIBD0.032768	Active	EOL
5055	<a href="https://abracon.com/downloads/ECN-PCN/7020-ECN-EOL-5055-FKT38.pdf">https://abracon.com/downloads/ECN-PCN/7020-ECN-EOL-5055-FKT38.pdf</a>	Fox	FKT38	FKT38EIH00.032768	Active	EOL
5055	<a href="https://abracon.com/downloads/ECN-PCN/7020-ECN-EOL-5055-FKT38.pdf">https://abracon.com/downloads/ECN-PCN/7020-ECN-EOL-5055-FKT38.pdf</a>	Fox	FKT38	FKT38EIHMO.032768	Active	EOL
5055	<a href="https://abracon.com/downloads/ECN-PCN/7020-ECN-EOL-5055-FKT38.pdf">https://abracon.com/downloads/ECN-PCN/7020-ECN-EOL-5055-FKT38.pdf</a>	Fox	FKT38	FKT38EIHQ0.032768	Active	EOL
5055	<a href="https://abracon.com/downloads/ECN-PCN/7020-ECN-EOL-5055-FKT38.pdf">https://abracon.com/downloads/ECN-PCN/7020-ECN-EOL-5055-FKT38.pdf</a>	Fox	FKT38	300LF-0.032768-5	Active	EOL
5056	<a href="https://abracon.com/downloads/ECN-PCN/7020-ECN-EOL-5056-FO5HL.pdf">https://abracon.com/downloads/ECN-PCN/7020-ECN-EOL-5056-FO5HL.pdf</a>	Fox	FO5HL	FO5HLBBM2.048	Active	EOL
5056	<a href="https://abracon.com/downloads/ECN-PCN/7020-ECN-EOL-5056-FO5HL.pdf">https://abracon.com/downloads/ECN-PCN/7020-ECN-EOL-5056-FO5HL.pdf</a>	Fox	FO5HL	550A-11.0592-1	Active	EOL
5057	<a href="https://abracon.com/downloads/ECN-PCN/7020-ECN-EOL-5057-FO5LS.pdf">https://abracon.com/downloads/ECN-PCN/7020-ECN-EOL-5057-FO5LS.pdf</a>	Fox	FO5LS	FO5LSCDM106.25-T1	Active	EOL
5057	<a href="https://abracon.com/downloads/ECN-PCN/7020-ECN-EOL-5057-FO5LS.pdf">https://abracon.com/downloads/ECN-PCN/7020-ECN-EOL-5057-FO5LS.pdf</a>	Fox	FO5LS	FO5LSCBM108.0	Active	EOL
5057	<a href="https://abracon.com/downloads/ECN-PCN/7020-ECN-EOL-5057-FO5LS.pdf">https://abracon.com/downloads/ECN-PCN/7020-ECN-EOL-5057-FO5LS.pdf</a>	Fox	FO5LS	FO5LSJDM200.0	Active	EOL
5057	<a href="https://abracon.com/downloads/ECN-PCN/7020-ECN-EOL-5057-FO5LS.pdf">https://abracon.com/downloads/ECN-PCN/7020-ECN-EOL-5057-FO5LS.pdf</a>	Fox	FO5LS	FO5LSCDM26.0	Active	EOL
5057	<a href="https://abracon.com/downloads/ECN-PCN/7020-ECN-EOL-5057-FO5LS.pdf">https://abracon.com/downloads/ECN-PCN/7020-ECN-EOL-5057-FO5LS.pdf</a>	Fox	FO5LS	FO5LSCBF48.0-T1	Active	EOL
5057	<a href="https://abracon.com/downloads/ECN-PCN/7020-ECN-EOL-5057-FO5LS.pdf">https://abracon.com/downloads/ECN-PCN/7020-ECN-EOL-5057-FO5LS.pdf</a>	Fox	FO5LS	FO5LSCDM125.0-T1	Active	EOL
5057	<a href="https://abracon.com/downloads/ECN-PCN/7020-ECN-EOL-5057-FO5LS.pdf">https://abracon.com/downloads/ECN-PCN/7020-ECN-EOL-5057-FO5LS.pdf</a>	Fox	FO5LS	FO5LSJBF72.0	Active	EOL
5057	<a href="https://abracon.com/downloads/ECN-PCN/7020-ECN-EOL-5057-FO5LS.pdf">https://abracon.com/downloads/ECN-PCN/7020-ECN-EOL-5057-FO5LS.pdf</a>	Fox	FO5LS	FO5LSCDM106.25	Active	EOL
5057	<a href="https://abracon.com/downloads/ECN-PCN/7020-ECN-EOL-5057-FO5LS.pdf">https://abracon.com/downloads/ECN-PCN/7020-ECN-EOL-5057-FO5LS.pdf</a>	Fox	FO5LS	FO5LSCDM100.00	Active	EOL
5058	<a href="https://abracon.com/downloads/ECN-PCN/7020-ECN-EOL-5058-FO6HS.pdf">https://abracon.com/downloads/ECN-PCN/7020-ECN-EOL-5058-FO6HS.pdf</a>	Fox	FO6HS	FO6HSCBM25.0-T1	Active	EOL
5058	<a href="https://abracon.com/downloads/ECN-PCN/7020-ECN-EOL-5058-FO6HS.pdf">https://abracon.com/downloads/ECN-PCN/7020-ECN-EOL-5058-FO6HS.pdf</a>	Fox	FO6HS	FO6HSCBM3.6864-T1	Active	EOL
5058	<a href="https://abracon.com/downloads/ECN-PCN/7020-ECN-EOL-5058-FO6HS.pdf">https://abracon.com/downloads/ECN-PCN/7020-ECN-EOL-5058-FO6HS.pdf</a>	Fox	FO6HS	FO6HSCAM30.0	Active	EOL
5059	<a href="https://abracon.com/downloads/ECN-PCN/7020-ECN-EOL-5059-FO7LS.pdf">https://abracon.com/downloads/ECN-PCN/7020-ECN-EOL-5059-FO7LS.pdf</a>	Fox	FO7LS	715-156.25-1	Active	EOL
5059	<a href="https://abracon.com/downloads/ECN-PCN/7020-ECN-EOL-5059-FO7LS.pdf">https://abracon.com/downloads/ECN-PCN/7020-ECN-EOL-5059-FO7LS.pdf</a>	Fox	FO7LS	FO7LSCBM150.0-T1	Active	EOL
5059	<a href="https://abracon.com/downloads/ECN-PCN/7020-ECN-EOL-5059-FO7LS.pdf">https://abracon.com/downloads/ECN-PCN/7020-ECN-EOL-5059-FO7LS.pdf</a>	Fox	FO7LS	FO7LSCBM25.0-T1	Active	EOL
5059	<a href="https://abracon.com/downloads/ECN-PCN/7020-ECN-EOL-5059-FO7LS.pdf">https://abracon.com/downloads/ECN-PCN/7020-ECN-EOL-5059-FO7LS.pdf</a>	Fox	FO7LS	FO7LSJBP150.0-T1	Active	EOL
5059	<a href="https://abracon.com/downloads/ECN-PCN/7020-ECN-EOL-5059-FO7LS.pdf">https://abracon.com/downloads/ECN-PCN/7020-ECN-EOL-5059-FO7LS.pdf</a>	Fox	FO7LS	FO7LSCDM26.0	Active	EOL
5059	<a href="https://abracon.com/downloads/ECN-PCN/7020-ECN-EOL-5059-FO7LS.pdf">https://abracon.com/downloads/ECN-PCN/7020-ECN-EOL-5059-FO7LS.pdf</a>	Fox	FO7LS	FO7LSJBP150.0	Active	EOL

5059	<a href="https://abracon.com/downloads/ECN-PCN/7020-ECN-EOL-5059-FO7LS.pdf">https://abracon.com/downloads/ECN-PCN/7020-ECN-EOL-5059-FO7LS.pdf</a>	Fox	FO7LS	FO7LSJBM100.0-T1	Active	EOL
5059	<a href="https://abracon.com/downloads/ECN-PCN/7020-ECN-EOL-5059-FO7LS.pdf">https://abracon.com/downloads/ECN-PCN/7020-ECN-EOL-5059-FO7LS.pdf</a>	Fox	FO7LS	FO7LSJBE125.0-T1	Active	EOL
5059	<a href="https://abracon.com/downloads/ECN-PCN/7020-ECN-EOL-5059-FO7LS.pdf">https://abracon.com/downloads/ECN-PCN/7020-ECN-EOL-5059-FO7LS.pdf</a>	Fox	FO7LS	FO7LSCBM150.0	Active	EOL
5060	<a href="https://abracon.com/downloads/ECN-PCN/7020-ECN-EOL-5060-FS5BC.pdf">https://abracon.com/downloads/ECN-PCN/7020-ECN-EOL-5060-FS5BC.pdf</a>	Fox	FS5BC	815-50-5	Active	EOL
5060	<a href="https://abracon.com/downloads/ECN-PCN/7020-ECN-EOL-5060-FS5BC.pdf">https://abracon.com/downloads/ECN-PCN/7020-ECN-EOL-5060-FS5BC.pdf</a>	Fox	FS5BC	FS5BCDC16.0-T1	Active	EOL
5060	<a href="https://abracon.com/downloads/ECN-PCN/7020-ECN-EOL-5060-FS5BC.pdf">https://abracon.com/downloads/ECN-PCN/7020-ECN-EOL-5060-FS5BC.pdf</a>	Fox	FS5BC	FS5SCBM12.0	Active	EOL
5066	<a href="https://abracon.com/downloads/ECN-PCN/7020-ECN-EOL-5066-FT3CV.pdf">https://abracon.com/downloads/ECN-PCN/7020-ECN-EOL-5066-FT3CV.pdf</a>	Fox	FT3CV	FT3CVBRM40.0	Active	EOL
5066	<a href="https://abracon.com/downloads/ECN-PCN/7020-ECN-EOL-5066-FT3CV.pdf">https://abracon.com/downloads/ECN-PCN/7020-ECN-EOL-5066-FT3CV.pdf</a>	Fox	FT3CV	FT3CVBTK36.864	Active	EOL
5066	<a href="https://abracon.com/downloads/ECN-PCN/7020-ECN-EOL-5066-FT3CV.pdf">https://abracon.com/downloads/ECN-PCN/7020-ECN-EOL-5066-FT3CV.pdf</a>	Fox	FT3CV	FT3CVQSK21.5	Active	EOL
5066	<a href="https://abracon.com/downloads/ECN-PCN/7020-ECN-EOL-5066-FT3CV.pdf">https://abracon.com/downloads/ECN-PCN/7020-ECN-EOL-5066-FT3CV.pdf</a>	Fox	FT3CV	638D-26-1	Active	EOL
5067	<a href="https://abracon.com/downloads/ECN-PCN/7020-ECN-EOL-5067-FT3HN.pdf">https://abracon.com/downloads/ECN-PCN/7020-ECN-EOL-5067-FT3HN.pdf</a>	Fox	FT3HN	FT3HNBPK10.0-T1	Active	EOL
5067	<a href="https://abracon.com/downloads/ECN-PCN/7020-ECN-EOL-5067-FT3HN.pdf">https://abracon.com/downloads/ECN-PCN/7020-ECN-EOL-5067-FT3HN.pdf</a>	Fox	FT3HN	FT3HNBPK12.0-T1	Active	EOL
5067	<a href="https://abracon.com/downloads/ECN-PCN/7020-ECN-EOL-5067-FT3HN.pdf">https://abracon.com/downloads/ECN-PCN/7020-ECN-EOL-5067-FT3HN.pdf</a>	Fox	FT3HN	FT3HNBPK24.576	Active	EOL
5067	<a href="https://abracon.com/downloads/ECN-PCN/7020-ECN-EOL-5067-FT3HN.pdf">https://abracon.com/downloads/ECN-PCN/7020-ECN-EOL-5067-FT3HN.pdf</a>	Fox	FT3HN	FT3HNBPK16.0-T1	Active	EOL
5067	<a href="https://abracon.com/downloads/ECN-PCN/7020-ECN-EOL-5067-FT3HN.pdf">https://abracon.com/downloads/ECN-PCN/7020-ECN-EOL-5067-FT3HN.pdf</a>	Fox	FT3HN	FT3HNBPK25.0-T1	Active	EOL
5067	<a href="https://abracon.com/downloads/ECN-PCN/7020-ECN-EOL-5067-FT3HN.pdf">https://abracon.com/downloads/ECN-PCN/7020-ECN-EOL-5067-FT3HN.pdf</a>	Fox	FT3HN	FT3HNBPK27.0-T1	Active	EOL
5067	<a href="https://abracon.com/downloads/ECN-PCN/7020-ECN-EOL-5067-FT3HN.pdf">https://abracon.com/downloads/ECN-PCN/7020-ECN-EOL-5067-FT3HN.pdf</a>	Fox	FT3HN	673CH-24.576-1	Active	EOL
5067	<a href="https://abracon.com/downloads/ECN-PCN/7020-ECN-EOL-5067-FT3HN.pdf">https://abracon.com/downloads/ECN-PCN/7020-ECN-EOL-5067-FT3HN.pdf</a>	Fox	FT3HN	673CH-32.768-1	Active	EOL
5068	<a href="https://abracon.com/downloads/ECN-PCN/7020-ECN-EOL-5068-FT3HV.pdf">https://abracon.com/downloads/ECN-PCN/7020-ECN-EOL-5068-FT3HV.pdf</a>	Fox	FT3HV	FT3HVBPM14.4-T1	Active	EOL
5068	<a href="https://abracon.com/downloads/ECN-PCN/7020-ECN-EOL-5068-FT3HV.pdf">https://abracon.com/downloads/ECN-PCN/7020-ECN-EOL-5068-FT3HV.pdf</a>	Fox	FT3HV	FT3HVBPM25.0-T1	Active	EOL
5068	<a href="https://abracon.com/downloads/ECN-PCN/7020-ECN-EOL-5068-FT3HV.pdf">https://abracon.com/downloads/ECN-PCN/7020-ECN-EOL-5068-FT3HV.pdf</a>	Fox	FT3HV	FT3HVBPK16.0-T1	Active	EOL
5068	<a href="https://abracon.com/downloads/ECN-PCN/7020-ECN-EOL-5068-FT3HV.pdf">https://abracon.com/downloads/ECN-PCN/7020-ECN-EOL-5068-FT3HV.pdf</a>	Fox	FT3HV	FT3HVBTF36.864-T3	Active	EOL
5068	<a href="https://abracon.com/downloads/ECN-PCN/7020-ECN-EOL-5068-FT3HV.pdf">https://abracon.com/downloads/ECN-PCN/7020-ECN-EOL-5068-FT3HV.pdf</a>	Fox	FT3HV	FT3HVBPM10.0-T1	Active	EOL
5068	<a href="https://abracon.com/downloads/ECN-PCN/7020-ECN-EOL-5068-FT3HV.pdf">https://abracon.com/downloads/ECN-PCN/7020-ECN-EOL-5068-FT3HV.pdf</a>	Fox	FT3HV	FT3HVBPM25.0	Active	EOL
5068	<a href="https://abracon.com/downloads/ECN-PCN/7020-ECN-EOL-5068-FT3HV.pdf">https://abracon.com/downloads/ECN-PCN/7020-ECN-EOL-5068-FT3HV.pdf</a>	Fox	FT3HV	FT3HVBPM14.4	Active	EOL
5069	<a href="https://abracon.com/downloads/ECN-PCN/7020-ECN-EOL-5069-FT5CV.pdf">https://abracon.com/downloads/ECN-PCN/7020-ECN-EOL-5069-FT5CV.pdf</a>	Fox	FT5CV	FT5CVDPK12.8-T1	Active	EOL
5069	<a href="https://abracon.com/downloads/ECN-PCN/7020-ECN-EOL-5069-FT5CV.pdf">https://abracon.com/downloads/ECN-PCN/7020-ECN-EOL-5069-FT5CV.pdf</a>	Fox	FT5CV	FT5CVDPK20.0	Active	EOL
5069	<a href="https://abracon.com/downloads/ECN-PCN/7020-ECN-EOL-5069-FT5CV.pdf">https://abracon.com/downloads/ECN-PCN/7020-ECN-EOL-5069-FT5CV.pdf</a>	Fox	FT5CV	FT5CVDPM16.0-T1	Active	EOL
5069	<a href="https://abracon.com/downloads/ECN-PCN/7020-ECN-EOL-5069-FT5CV.pdf">https://abracon.com/downloads/ECN-PCN/7020-ECN-EOL-5069-FT5CV.pdf</a>	Fox	FT5CV	FT5CVDPK13.0-T1	Active	EOL
5069	<a href="https://abracon.com/downloads/ECN-PCN/7020-ECN-EOL-5069-FT5CV.pdf">https://abracon.com/downloads/ECN-PCN/7020-ECN-EOL-5069-FT5CV.pdf</a>	Fox	FT5CV	FT5CVDPK15.36-T1	Active	EOL
5069	<a href="https://abracon.com/downloads/ECN-PCN/7020-ECN-EOL-5069-FT5CV.pdf">https://abracon.com/downloads/ECN-PCN/7020-ECN-EOL-5069-FT5CV.pdf</a>	Fox	FT5CV	FT5CVDTK26.0-T1	Active	EOL
5069	<a href="https://abracon.com/downloads/ECN-PCN/7020-ECN-EOL-5069-FT5CV.pdf">https://abracon.com/downloads/ECN-PCN/7020-ECN-EOL-5069-FT5CV.pdf</a>	Fox	FT5CV	491-10-7	Active	EOL
5070	<a href="https://abracon.com/downloads/ECN-PCN/7020-ECN-EOL-5070-FT5HV.pdf">https://abracon.com/downloads/ECN-PCN/7020-ECN-EOL-5070-FT5HV.pdf</a>	Fox	FT5HV	FT5HVBPK10.0-T1	Active	EOL
5070	<a href="https://abracon.com/downloads/ECN-PCN/7020-ECN-EOL-5070-FT5HV.pdf">https://abracon.com/downloads/ECN-PCN/7020-ECN-EOL-5070-FT5HV.pdf</a>	Fox	FT5HV	FT5HVBPK16.384-T1	Active	EOL
5070	<a href="https://abracon.com/downloads/ECN-PCN/7020-ECN-EOL-5070-FT5HV.pdf">https://abracon.com/downloads/ECN-PCN/7020-ECN-EOL-5070-FT5HV.pdf</a>	Fox	FT5HV	719-25-10	Active	EOL
5070	<a href="https://abracon.com/downloads/ECN-PCN/7020-ECN-EOL-5070-FT5HV.pdf">https://abracon.com/downloads/ECN-PCN/7020-ECN-EOL-5070-FT5HV.pdf</a>	Fox	FT5HV	719-20-6	Active	EOL
5070	<a href="https://abracon.com/downloads/ECN-PCN/7020-ECN-EOL-5070-FT5HV.pdf">https://abracon.com/downloads/ECN-PCN/7020-ECN-EOL-5070-FT5HV.pdf</a>	Fox	FT5HV	719-16.384-4	Active	EOL
5070	<a href="https://abracon.com/downloads/ECN-PCN/7020-ECN-EOL-5070-FT5HV.pdf">https://abracon.com/downloads/ECN-PCN/7020-ECN-EOL-5070-FT5HV.pdf</a>	Fox	FT5HV	FT5HVBPK16.384	Active	EOL
5070	<a href="https://abracon.com/downloads/ECN-PCN/7020-ECN-EOL-5070-FT5HV.pdf">https://abracon.com/downloads/ECN-PCN/7020-ECN-EOL-5070-FT5HV.pdf</a>	Fox	FT5HV	FT5HVBPK10.0	Active	EOL
5071	<a href="https://abracon.com/downloads/ECN-PCN/7020-ECN-EOL-5071-26.pdf">https://abracon.com/downloads/ECN-PCN/7020-ECN-EOL-5071-26.pdf</a>	ILSI	26	26-HX3F6-32.768 KHZ	Active	EOL
5071	<a href="https://abracon.com/downloads/ECN-PCN/7020-ECN-EOL-5071-26.pdf">https://abracon.com/downloads/ECN-PCN/7020-ECN-EOL-5071-26.pdf</a>	ILSI	26	ILSI-QVS-1382	Active	EOL
5071	<a href="https://abracon.com/downloads/ECN-PCN/7020-ECN-EOL-5071-26.pdf">https://abracon.com/downloads/ECN-PCN/7020-ECN-EOL-5071-26.pdf</a>	ILSI	26	26-JX5F3.7-32.768 KHZ	Active	EOL
5071	<a href="https://abracon.com/downloads/ECN-PCN/7020-ECN-EOL-5071-26.pdf">https://abracon.com/downloads/ECN-PCN/7020-ECN-EOL-5071-26.pdf</a>	ILSI	26	26-JX5F4.4-32.768 KHZ	Active	EOL
5071	<a href="https://abracon.com/downloads/ECN-PCN/7020-ECN-EOL-5071-26.pdf">https://abracon.com/downloads/ECN-PCN/7020-ECN-EOL-5071-26.pdf</a>	ILSI	26	26-HX5F12.5-32.768 KHZ	Active	EOL
5071	<a href="https://abracon.com/downloads/ECN-PCN/7020-ECN-EOL-5071-26.pdf">https://abracon.com/downloads/ECN-PCN/7020-ECN-EOL-5071-26.pdf</a>	ILSI	26	26-JX2F12.5-32.768 KHZ	Active	EOL
5071	<a href="https://abracon.com/downloads/ECN-PCN/7020-ECN-EOL-5071-26.pdf">https://abracon.com/downloads/ECN-PCN/7020-ECN-EOL-5071-26.pdf</a>	ILSI	26	26-HX5F10-77.503 KHZ	Active	EOL
5071	<a href="https://abracon.com/downloads/ECN-PCN/7020-ECN-EOL-5071-26.pdf">https://abracon.com/downloads/ECN-PCN/7020-ECN-EOL-5071-26.pdf</a>	ILSI	26	26-BX2F11-140.000 KHZ	Active	EOL
5072	<a href="https://abracon.com/downloads/ECN-PCN/7020-ECN-EOL-5072-HC49US.pdf">https://abracon.com/downloads/ECN-PCN/7020-ECN-EOL-5072-HC49US.pdf</a>	ILSI	HC49US	HC49US-FF3F18-11.0592 MHZ	Active	EOL
5072	<a href="https://abracon.com/downloads/ECN-PCN/7020-ECN-EOL-5072-HC49US.pdf">https://abracon.com/downloads/ECN-PCN/7020-ECN-EOL-5072-HC49US.pdf</a>	ILSI	HC49US	HC49US-FF3F18-10.000 MHZ	Active	EOL
5072	<a href="https://abracon.com/downloads/ECN-PCN/7020-ECN-EOL-5072-HC49US.pdf">https://abracon.com/downloads/ECN-PCN/7020-ECN-EOL-5072-HC49US.pdf</a>	ILSI	HC49US	HC49US-FF3F18-12.000 MHZ	Active	EOL
5072	<a href="https://abracon.com/downloads/ECN-PCN/7020-ECN-EOL-5072-HC49US.pdf">https://abracon.com/downloads/ECN-PCN/7020-ECN-EOL-5072-HC49US.pdf</a>	ILSI	HC49US	HC49US-FF3F18-14.31818 MHZ	Active	EOL
5072	<a href="https://abracon.com/downloads/ECN-PCN/7020-ECN-EOL-5072-HC49US.pdf">https://abracon.com/downloads/ECN-PCN/7020-ECN-EOL-5072-HC49US.pdf</a>	ILSI	HC49US	HC49US-FF3F18-14.7456 MHZ	Active	EOL
5072	<a href="https://abracon.com/downloads/ECN-PCN/7020-ECN-EOL-5072-HC49US.pdf">https://abracon.com/downloads/ECN-PCN/7020-ECN-EOL-5072-HC49US.pdf</a>	ILSI	HC49US	HC49US-FF3F18-16.000 MHZ	Active	EOL















5094	<a href="https://abracon.com/downloads/ECN-PCN/7020-ECN-EOL-5094-F.pdf">https://abracon.com/downloads/ECN-PCN/7020-ECN-EOL-5094-F.pdf</a>	MMD	F	FF18EB1-25.000MHZ-T	Active	EOL
5094	<a href="https://abracon.com/downloads/ECN-PCN/7020-ECN-EOL-5094-F.pdf">https://abracon.com/downloads/ECN-PCN/7020-ECN-EOL-5094-F.pdf</a>	MMD	F	FF40BI1-8.704MHZ	Active	EOL
5094	<a href="https://abracon.com/downloads/ECN-PCN/7020-ECN-EOL-5094-F.pdf">https://abracon.com/downloads/ECN-PCN/7020-ECN-EOL-5094-F.pdf</a>	MMD	F	FF40BI1-8.704MHZ-T	Active	EOL
5094	<a href="https://abracon.com/downloads/ECN-PCN/7020-ECN-EOL-5094-F.pdf">https://abracon.com/downloads/ECN-PCN/7020-ECN-EOL-5094-F.pdf</a>	MMD	F	FF20BC1-8.000MHZ-T	Active	EOL
5094	<a href="https://abracon.com/downloads/ECN-PCN/7020-ECN-EOL-5094-F.pdf">https://abracon.com/downloads/ECN-PCN/7020-ECN-EOL-5094-F.pdf</a>	MMD	F	FF20DC1-25.000MHZ-T	Active	EOL
5094	<a href="https://abracon.com/downloads/ECN-PCN/7020-ECN-EOL-5094-F.pdf">https://abracon.com/downloads/ECN-PCN/7020-ECN-EOL-5094-F.pdf</a>	MMD	F	FF18AA1-33.8008MHZ-T	Active	EOL
5094	<a href="https://abracon.com/downloads/ECN-PCN/7020-ECN-EOL-5094-F.pdf">https://abracon.com/downloads/ECN-PCN/7020-ECN-EOL-5094-F.pdf</a>	MMD	F	FF20AC1-8.000MHZ-T	Active	EOL
5094	<a href="https://abracon.com/downloads/ECN-PCN/7020-ECN-EOL-5094-F.pdf">https://abracon.com/downloads/ECN-PCN/7020-ECN-EOL-5094-F.pdf</a>	MMD	F	FF18AA1-33.7640MHZ-T	Active	EOL
5094	<a href="https://abracon.com/downloads/ECN-PCN/7020-ECN-EOL-5094-F.pdf">https://abracon.com/downloads/ECN-PCN/7020-ECN-EOL-5094-F.pdf</a>	MMD	F	FF18AA1-33.7824MHZ-T	Active	EOL
5094	<a href="https://abracon.com/downloads/ECN-PCN/7020-ECN-EOL-5094-F.pdf">https://abracon.com/downloads/ECN-PCN/7020-ECN-EOL-5094-F.pdf</a>	MMD	F	FF18AA1-12.000MHZ-T	Active	EOL
5094	<a href="https://abracon.com/downloads/ECN-PCN/7020-ECN-EOL-5094-F.pdf">https://abracon.com/downloads/ECN-PCN/7020-ECN-EOL-5094-F.pdf</a>	MMD	F	FF18AA1-33.7450MHZ-T	Active	EOL
5094	<a href="https://abracon.com/downloads/ECN-PCN/7020-ECN-EOL-5094-F.pdf">https://abracon.com/downloads/ECN-PCN/7020-ECN-EOL-5094-F.pdf</a>	MMD	F	FF18EA1-14.7456MHZ-T	Active	EOL
5094	<a href="https://abracon.com/downloads/ECN-PCN/7020-ECN-EOL-5094-F.pdf">https://abracon.com/downloads/ECN-PCN/7020-ECN-EOL-5094-F.pdf</a>	MMD	F	FF10AC1-13.560MHZ-T	Active	EOL
5095	<a href="https://abracon.com/downloads/ECN-PCN/7020-ECN-EOL-5095-MTES.pdf">https://abracon.com/downloads/ECN-PCN/7020-ECN-EOL-5095-MTES.pdf</a>	MMD	MTES	MTESF520C-39.950MHZ-T	Active	EOL
5096	<a href="https://abracon.com/downloads/ECN-PCN/7020-ECN-EOL-5096-MTTB.pdf">https://abracon.com/downloads/ECN-PCN/7020-ECN-EOL-5096-MTTB.pdf</a>	MMD	MTTB	MTTBH325FV-25.000MHZ	Active	EOL
5096	<a href="https://abracon.com/downloads/ECN-PCN/7020-ECN-EOL-5096-MTTB.pdf">https://abracon.com/downloads/ECN-PCN/7020-ECN-EOL-5096-MTTB.pdf</a>	MMD	MTTB	MTTBH325FV-25.000MHZ-T	Active	EOL
5096	<a href="https://abracon.com/downloads/ECN-PCN/7020-ECN-EOL-5096-MTTB.pdf">https://abracon.com/downloads/ECN-PCN/7020-ECN-EOL-5096-MTTB.pdf</a>	MMD	MTTB	MTTBH325FV-14.7456MHZ	Active	EOL
5096	<a href="https://abracon.com/downloads/ECN-PCN/7020-ECN-EOL-5096-MTTB.pdf">https://abracon.com/downloads/ECN-PCN/7020-ECN-EOL-5096-MTTB.pdf</a>	MMD	MTTB	MTTBH325FV-14.7456MHZ-T	Active	EOL
5096	<a href="https://abracon.com/downloads/ECN-PCN/7020-ECN-EOL-5096-MTTB.pdf">https://abracon.com/downloads/ECN-PCN/7020-ECN-EOL-5096-MTTB.pdf</a>	MMD	MTTB	MTTBH325F-25.000 MHZ	Active	EOL
5096	<a href="https://abracon.com/downloads/ECN-PCN/7020-ECN-EOL-5096-MTTB.pdf">https://abracon.com/downloads/ECN-PCN/7020-ECN-EOL-5096-MTTB.pdf</a>	MMD	MTTB	MTTBH325F-25.000MHZ	Active	EOL
5096	<a href="https://abracon.com/downloads/ECN-PCN/7020-ECN-EOL-5096-MTTB.pdf">https://abracon.com/downloads/ECN-PCN/7020-ECN-EOL-5096-MTTB.pdf</a>	MMD	MTTB	MTTBH325F-14.7456MHZ	Active	EOL
5096	<a href="https://abracon.com/downloads/ECN-PCN/7020-ECN-EOL-5096-MTTB.pdf">https://abracon.com/downloads/ECN-PCN/7020-ECN-EOL-5096-MTTB.pdf</a>	MMD	MTTB	MTTBH325F-25.000MHZ-T	Active	EOL
5096	<a href="https://abracon.com/downloads/ECN-PCN/7020-ECN-EOL-5096-MTTB.pdf">https://abracon.com/downloads/ECN-PCN/7020-ECN-EOL-5096-MTTB.pdf</a>	MMD	MTTB	MTTBS320C-24.000MHZ-T	Active	EOL
5096	<a href="https://abracon.com/downloads/ECN-PCN/7020-ECN-EOL-5096-MTTB.pdf">https://abracon.com/downloads/ECN-PCN/7020-ECN-EOL-5096-MTTB.pdf</a>	MMD	MTTB	MTTBS320C-10.000MHZ-T	Active	EOL
5096	<a href="https://abracon.com/downloads/ECN-PCN/7020-ECN-EOL-5096-MTTB.pdf">https://abracon.com/downloads/ECN-PCN/7020-ECN-EOL-5096-MTTB.pdf</a>	MMD	MTTB	MTTBS320C-24.000MHZ	Active	EOL
5097	<a href="https://abracon.com/downloads/ECN-PCN/7020-ECN-EOL-5097-WC315.pdf">https://abracon.com/downloads/ECN-PCN/7020-ECN-EOL-5097-WC315.pdf</a>	MMD	WC315	WC315-32.768KHZ-T	Active	EOL
5097	<a href="https://abracon.com/downloads/ECN-PCN/7020-ECN-EOL-5097-WC315.pdf">https://abracon.com/downloads/ECN-PCN/7020-ECN-EOL-5097-WC315.pdf</a>	MMD	WC315	WC315-32.768KHZ	Active	EOL
5098	<a href="https://abracon.com/downloads/ECN-PCN/7020-ECN-EOL-5098-151.pdf">https://abracon.com/downloads/ECN-PCN/7020-ECN-EOL-5098-151.pdf</a>	Oscilent	151	151-3.6864M-10-W-TR	Active	EOL
5098	<a href="https://abracon.com/downloads/ECN-PCN/7020-ECN-EOL-5098-151.pdf">https://abracon.com/downloads/ECN-PCN/7020-ECN-EOL-5098-151.pdf</a>	Oscilent	151	151-20.000M-32-25GS	Active	EOL
5098	<a href="https://abracon.com/downloads/ECN-PCN/7020-ECN-EOL-5098-151.pdf">https://abracon.com/downloads/ECN-PCN/7020-ECN-EOL-5098-151.pdf</a>	Oscilent	151	151-25.0M-20-20HP-IT	Active	EOL
5098	<a href="https://abracon.com/downloads/ECN-PCN/7020-ECN-EOL-5098-151.pdf">https://abracon.com/downloads/ECN-PCN/7020-ECN-EOL-5098-151.pdf</a>	Oscilent	151	151-16.384M-20-P-IT	Active	EOL
5098	<a href="https://abracon.com/downloads/ECN-PCN/7020-ECN-EOL-5098-151.pdf">https://abracon.com/downloads/ECN-PCN/7020-ECN-EOL-5098-151.pdf</a>	Oscilent	151	151-16.0M-20-W	Active	EOL
5098	<a href="https://abracon.com/downloads/ECN-PCN/7020-ECN-EOL-5098-151.pdf">https://abracon.com/downloads/ECN-PCN/7020-ECN-EOL-5098-151.pdf</a>	Oscilent	151	151-7.3728M-SR-W-TR	Active	EOL
5099	<a href="https://abracon.com/downloads/ECN-PCN/7020-ECN-EOL-5099-223.pdf">https://abracon.com/downloads/ECN-PCN/7020-ECN-EOL-5099-223.pdf</a>	Oscilent	223	223-000312-20-TR	Active	EOL
5099	<a href="https://abracon.com/downloads/ECN-PCN/7020-ECN-EOL-5099-223.pdf">https://abracon.com/downloads/ECN-PCN/7020-ECN-EOL-5099-223.pdf</a>	Oscilent	223	223-000306-20-LF-TR	Active	EOL
5099	<a href="https://abracon.com/downloads/ECN-PCN/7020-ECN-EOL-5099-223.pdf">https://abracon.com/downloads/ECN-PCN/7020-ECN-EOL-5099-223.pdf</a>	Oscilent	223	223-000312-20	Active	EOL
5100	<a href="https://abracon.com/downloads/ECN-PCN/7020-ECN-EOL-5100-253.pdf">https://abracon.com/downloads/ECN-PCN/7020-ECN-EOL-5100-253.pdf</a>	Oscilent	253	253-9.8304M-20-S-TR	Active	EOL
5100	<a href="https://abracon.com/downloads/ECN-PCN/7020-ECN-EOL-5100-253.pdf">https://abracon.com/downloads/ECN-PCN/7020-ECN-EOL-5100-253.pdf</a>	Oscilent	253	253-6.0M-18-GW	Active	EOL
5100	<a href="https://abracon.com/downloads/ECN-PCN/7020-ECN-EOL-5100-253.pdf">https://abracon.com/downloads/ECN-PCN/7020-ECN-EOL-5100-253.pdf</a>	Oscilent	253	253-7.3728M-SR-S-TR	Active	EOL
5100	<a href="https://abracon.com/downloads/ECN-PCN/7020-ECN-EOL-5100-253.pdf">https://abracon.com/downloads/ECN-PCN/7020-ECN-EOL-5100-253.pdf</a>	Oscilent	253	253-20.0M-18-GW	Active	EOL
5100	<a href="https://abracon.com/downloads/ECN-PCN/7020-ECN-EOL-5100-253.pdf">https://abracon.com/downloads/ECN-PCN/7020-ECN-EOL-5100-253.pdf</a>	Oscilent	253	253-4.0M-18-W	Active	EOL
5100	<a href="https://abracon.com/downloads/ECN-PCN/7020-ECN-EOL-5100-253.pdf">https://abracon.com/downloads/ECN-PCN/7020-ECN-EOL-5100-253.pdf</a>	Oscilent	253	253-6.0M-10-GW	Active	EOL
5100	<a href="https://abracon.com/downloads/ECN-PCN/7020-ECN-EOL-5100-253.pdf">https://abracon.com/downloads/ECN-PCN/7020-ECN-EOL-5100-253.pdf</a>	Oscilent	253	253-20.0M-10-GW	Active	EOL
5100	<a href="https://abracon.com/downloads/ECN-PCN/7020-ECN-EOL-5100-253.pdf">https://abracon.com/downloads/ECN-PCN/7020-ECN-EOL-5100-253.pdf</a>	Oscilent	253	253-16.0M-18-GW	Active	EOL
5100	<a href="https://abracon.com/downloads/ECN-PCN/7020-ECN-EOL-5100-253.pdf">https://abracon.com/downloads/ECN-PCN/7020-ECN-EOL-5100-253.pdf</a>	Oscilent	253	253-16.0M-10-GW	Active	EOL
5100	<a href="https://abracon.com/downloads/ECN-PCN/7020-ECN-EOL-5100-253.pdf">https://abracon.com/downloads/ECN-PCN/7020-ECN-EOL-5100-253.pdf</a>	Oscilent	253	253-10.0M-18-GW	Active	EOL
5100	<a href="https://abracon.com/downloads/ECN-PCN/7020-ECN-EOL-5100-253.pdf">https://abracon.com/downloads/ECN-PCN/7020-ECN-EOL-5100-253.pdf</a>	Oscilent	253	253-12.0M-18-50GS	Active	EOL
5100	<a href="https://abracon.com/downloads/ECN-PCN/7020-ECN-EOL-5100-253.pdf">https://abracon.com/downloads/ECN-PCN/7020-ECN-EOL-5100-253.pdf</a>	Oscilent	253	253-10.0M-10-GW	Active	EOL
5100	<a href="https://abracon.com/downloads/ECN-PCN/7020-ECN-EOL-5100-253.pdf">https://abracon.com/downloads/ECN-PCN/7020-ECN-EOL-5100-253.pdf</a>	Oscilent	253	253-7.3728M-SR-W-TR	Active	EOL
5100	<a href="https://abracon.com/downloads/ECN-PCN/7020-ECN-EOL-5100-253.pdf">https://abracon.com/downloads/ECN-PCN/7020-ECN-EOL-5100-253.pdf</a>	Oscilent	253	253-6.0M-20-S	Active	EOL
5100	<a href="https://abracon.com/downloads/ECN-PCN/7020-ECN-EOL-5100-253.pdf">https://abracon.com/downloads/ECN-PCN/7020-ECN-EOL-5100-253.pdf</a>	Oscilent	253	253-11.0592M-16-50-W	Active	EOL
5100	<a href="https://abracon.com/downloads/ECN-PCN/7020-ECN-EOL-5100-253.pdf">https://abracon.com/downloads/ECN-PCN/7020-ECN-EOL-5100-253.pdf</a>	Oscilent	253	253-4.0M-30-50NW	Active	EOL
5100	<a href="https://abracon.com/downloads/ECN-PCN/7020-ECN-EOL-5100-253.pdf">https://abracon.com/downloads/ECN-PCN/7020-ECN-EOL-5100-253.pdf</a>	Oscilent	253	253-20.0M-SR-S-TR	Active	EOL









































M1643	https://abracon.com/downloads/ECN-PCN/ECN-EOL-M1643-LAN-Transformer-APT-ALAN-Series-Notific	Abracon	ALAN-2401	ALAN-2401-T	Active	EOL
M1643	https://abracon.com/downloads/ECN-PCN/ECN-EOL-M1643-LAN-Transformer-APT-ALAN-Series-Notific	Abracon	ALAN-2402	ALAN-2402	Active	EOL
M1643	https://abracon.com/downloads/ECN-PCN/ECN-EOL-M1643-LAN-Transformer-APT-ALAN-Series-Notific	Abracon	ALAN-2402	ALAN-2402-T	Active	EOL
M1637	https://abracon.com/downloads/ECN-PCN/ECN-EOL-M1637-ALAN-409-Notification.pdf	Abracon	ALAN-409	ALAN-409	Active	EOL
M1637	https://abracon.com/downloads/ECN-PCN/ECN-EOL-M1637-ALAN-409-Notification.pdf	Abracon	ALAN-409	ALAN-409-T	Active	EOL
M1643	https://abracon.com/downloads/ECN-PCN/ECN-EOL-M1643-LAN-Transformer-APT-ALAN-Series-Notific	Abracon	APT-106	APT-106	Active	EOL
M1644	https://abracon.com/downloads/ECN-PCN/ECN-EOL-M1644-RJ45-JACK-ARJ-ARJE-Series-Notification.p	Abracon	ARJ012-110553	ARJ012-110553	Active	EOL
M1644	https://abracon.com/downloads/ECN-PCN/ECN-EOL-M1644-RJ45-JACK-ARJ-ARJE-Series-Notification.p	Abracon	ARJ-101D	ARJ-101D	Active	EOL
M1636	https://abracon.com/downloads/ECN-PCN/ECN-EOL-M1636-ARJ-177-Notification.pdf	Abracon	ARJ-177	ARJ-177	Active	EOL
M1639	https://abracon.com/downloads/ECN-PCN/ECN-EOL-M1639-ARJ-194-Notification.pdf	Abracon	ARJ-194	ARJ-194	Active	EOL
M1638	https://abracon.com/downloads/ECN-PCN/ECN-EOL-M1638-ARJ-263-Notification.pdf	Abracon	ARJ-263	ARJ-263	Active	EOL
M1641	https://abracon.com/downloads/ECN-PCN/ECN-EOL-M1641-ARJ268-359976-Notification.pdf	Abracon	ARJ268-359976	ARJ268-359976	Active	EOL
M1644	https://abracon.com/downloads/ECN-PCN/ECN-EOL-M1644-RJ45-JACK-ARJ-ARJE-Series-Notification.p	Abracon	ARJE-26	ARJE-0026	Active	EOL
M1644	https://abracon.com/downloads/ECN-PCN/ECN-EOL-M1644-RJ45-JACK-ARJ-ARJE-Series-Notification.p	Abracon	ARJE-27	ARJE-0027	Active	EOL
M1644	https://abracon.com/downloads/ECN-PCN/ECN-EOL-M1644-RJ45-JACK-ARJ-ARJE-Series-Notification.p	Abracon	ARJE-28	ARJE-0028	Active	EOL
M1644	https://abracon.com/downloads/ECN-PCN/ECN-EOL-M1644-RJ45-JACK-ARJ-ARJE-Series-Notification.p	Abracon	ARJE-40	ARJE-0040	Active	EOL
M1644	https://abracon.com/downloads/ECN-PCN/ECN-EOL-M1644-RJ45-JACK-ARJ-ARJE-Series-Notification.p	Abracon	ARJE-41	ARJE-0041	Active	EOL
M1644	https://abracon.com/downloads/ECN-PCN/ECN-EOL-M1644-RJ45-JACK-ARJ-ARJE-Series-Notification.p	Abracon	ARJE-51	ARJE-0051-MASA	Active	EOL
M1644	https://abracon.com/downloads/ECN-PCN/ECN-EOL-M1644-RJ45-JACK-ARJ-ARJE-Series-Notification.p	Abracon	ARJE-51	ARJE-0051-MASB	Active	EOL
M1644	https://abracon.com/downloads/ECN-PCN/ECN-EOL-M1644-RJ45-JACK-ARJ-ARJE-Series-Notification.p	Abracon	ARJE-51	ARJE-0051-MBSA	Active	EOL
M1644	https://abracon.com/downloads/ECN-PCN/ECN-EOL-M1644-RJ45-JACK-ARJ-ARJE-Series-Notification.p	Abracon	ARJE-51	ARJE-0051-MBSB	Active	EOL
M1644	https://abracon.com/downloads/ECN-PCN/ECN-EOL-M1644-RJ45-JACK-ARJ-ARJE-Series-Notification.p	Abracon	ARJG11A-M0011AB	ARJG11A-M0011AB	Active	EOL
M1644	https://abracon.com/downloads/ECN-PCN/ECN-EOL-M1644-RJ45-JACK-ARJ-ARJE-Series-Notification.p	Abracon	ARJG11A-M0011ABDWD	ARJG11A-M0011ABDWD	Active	EOL
M1644	https://abracon.com/downloads/ECN-PCN/ECN-EOL-M1644-RJ45-JACK-ARJ-ARJE-Series-Notification.p	Abracon	ARJG11A-M0011ABEWD	ARJG11A-M0011ABEWD	Active	EOL
M1640	https://abracon.com/downloads/ECN-PCN/ECN-EOL-M1640-ARJU31A-Notification.pdf	Abracon	ARJU31A-MASA	ARJU31A-MASA-AD-B-E-LU2	Active	EOL
R0372	https://abracon.com/downloads/ECN-PCN/7020-ECN-EOL-R0372.pdf	Abracon	808	808-RF1575.42M-A	Active	EOL
R0372	https://abracon.com/downloads/ECN-PCN/7020-ECN-EOL-R0372.pdf	Abracon	665	665-455-24	Active	EOL
R0372	https://abracon.com/downloads/ECN-PCN/7020-ECN-EOL-R0372.pdf	Abracon	800	800-RF1880.0M-B	Active	EOL
R0372	https://abracon.com/downloads/ECN-PCN/7020-ECN-EOL-R0372.pdf	Abracon	970	970-0107-A5-A001-TR	Active	EOL
R0372	https://abracon.com/downloads/ECN-PCN/7020-ECN-EOL-R0372.pdf	Abracon	A2450M000000S007	A2450M000000S007	Active	EOL
R0372	https://abracon.com/downloads/ECN-PCN/7020-ECN-EOL-R0372.pdf	Abracon	ABH10C55L	ABH10C55L-0174S	Active	EOL
R0372	https://abracon.com/downloads/ECN-PCN/7020-ECN-EOL-R0372.pdf	Abracon	ABH5008S	ABH5008SS-0350C	Active	EOL
R0372	https://abracon.com/downloads/ECN-PCN/7020-ECN-EOL-R0372.pdf	Abracon	ABSNSAAA-L1L5B1G1	ABSNSAAA-L1L5B1G1	Active	EOL
R0372	https://abracon.com/downloads/ECN-PCN/7020-ECN-EOL-R0372.pdf	Abracon	AEAC-0010	AEAC-0010	Active	EOL
R0372	https://abracon.com/downloads/ECN-PCN/7020-ECN-EOL-R0372.pdf	Abracon	AEBC02C07EBG	AEBC02C07EBG	Active	EOL
R0372	https://abracon.com/downloads/ECN-PCN/7020-ECN-EOL-R0372.pdf	Abracon	AEBC1001E	AEBC1001ES-SS	Active	EOL
R0372	https://abracon.com/downloads/ECN-PCN/7020-ECN-EOL-R0372.pdf	Abracon	AECC4405F	AECC4405F-A	Active	EOL
R0372	https://abracon.com/downloads/ECN-PCN/7020-ECN-EOL-R0372.pdf	Abracon	AECW0801W3	AECW0801W3S-0900S	Active	EOL
R0372	https://abracon.com/downloads/ECN-PCN/7020-ECN-EOL-R0372.pdf	Abracon	AETC2303L	AETC2303LS-SS	Active	EOL
R0372	https://abracon.com/downloads/ECN-PCN/7020-ECN-EOL-R0372.pdf	Abracon	AEWU0903S	AEWU0903S-3000S	Active	EOL
R0372	https://abracon.com/downloads/ECN-PCN/7020-ECN-EOL-R0372.pdf	Abracon	AFAG-0005	AFAG-0005	Active	EOL
R0372	https://abracon.com/downloads/ECN-PCN/7020-ECN-EOL-R0372.pdf	Abracon	AFR2723N	AFR2723NS-0100S	Active	EOL
R0378	https://abracon.com/downloads/ECN-PCN/7020-ECN-EOL-R0378.pdf	Abracon	AFS20A02	AFS20A02-1575.42-T3	Active	EOL
R0372	https://abracon.com/downloads/ECN-PCN/7020-ECN-EOL-R0372.pdf	Abracon	APAE1090R4060EBDB1	APAE1090R4060EBDB1-T	Active	EOL
R0372	https://abracon.com/downloads/ECN-PCN/7020-ECN-EOL-R0372.pdf	Abracon	APAE868R2540JGDD5	APAE868R2540JGDD5-T	Active	EOL
R0372	https://abracon.com/downloads/ECN-PCN/7020-ECN-EOL-R0372.pdf	Abracon	APAK-0003	APAK-0003	Active	EOL
R0372	https://abracon.com/downloads/ECN-PCN/7020-ECN-EOL-R0372.pdf	Abracon	APAK-0004	APAK-0004	Active	EOL
R0372	https://abracon.com/downloads/ECN-PCN/7020-ECN-EOL-R0372.pdf	Abracon	APKD2506G4	APKD2506G4-0220S	Active	EOL
R0372	https://abracon.com/downloads/ECN-PCN/7020-ECN-EOL-R0372.pdf	Abracon	ARRAN5-0009	ARRAN5-0009	Active	EOL
R0372	https://abracon.com/downloads/ECN-PCN/7020-ECN-EOL-R0372.pdf	Abracon	ARRG-0005	ARRG-0005	Active	EOL
R0372	https://abracon.com/downloads/ECN-PCN/7020-ECN-EOL-R0372.pdf	Abracon	F455K000S001	F455K000S001	Active	EOL
R0372	https://abracon.com/downloads/ECN-PCN/7020-ECN-EOL-R0372.pdf	Abracon	F455K000S016	F455K000S016	Active	EOL
R0372	https://abracon.com/downloads/ECN-PCN/7020-ECN-EOL-R0372.pdf	Abracon	F455K000S022	F455K000S022	Active	EOL

R0390	https://abracon.com/downloads/ECN-PCN/7020-ECN-EOL-R0390.pdf	Abracon	PRO-IS-265	PRO-IS-265	Active	EOL
R0372	https://abracon.com/downloads/ECN-PCN/7020-ECN-EOL-R0372.pdf	Abracon	PRO-OB-571	PRO-OB-571	Active	EOL
R0372	https://abracon.com/downloads/ECN-PCN/7020-ECN-EOL-R0372.pdf	Abracon	PRO-OB-599	PRO-OB-599	Active	EOL
R0372	https://abracon.com/downloads/ECN-PCN/7020-ECN-EOL-R0372.pdf	Abracon	PRO-OB-614	PRO-OB-614	Active	EOL
R0373	https://abracon.com/downloads/ECN-PCN/7020-ECN-EOL-R0373.pdf	Abracon	ACAR3005-C2WB-EVB	ACAR3005-C2WB-EVB	Active	EOL
R0373	https://abracon.com/downloads/ECN-PCN/7020-ECN-EOL-R0373.pdf	Abracon	ACAR3005-S824-EVB	ACAR3005-S824-EVB	Active	EOL
R0373	https://abracon.com/downloads/ECN-PCN/7020-ECN-EOL-R0373.pdf	Abracon	ACAR3705-SB-EVB	ACAR3705-SB-EVB	Active	EOL
R0373	https://abracon.com/downloads/ECN-PCN/7020-ECN-EOL-R0373.pdf	Abracon	ACAR4008-S698-EVB	ACAR4008-S698-EVB	Active	EOL
R0374	https://abracon.com/downloads/ECN-PCN/7020-ECN-EOL-R0374.pdf	Abracon	ACAR3705-SB	ACAR3705-SB	Active	EOL
R0374	https://abracon.com/downloads/ECN-PCN/7020-ECN-EOL-R0374.pdf	Abracon	AMCA52-2R510G-S1F	AMCA52-2R510G-S1F-T4	Active	EOL
R0374	https://abracon.com/downloads/ECN-PCN/7020-ECN-EOL-R0374.pdf	Abracon	AMCA52-2R510G-S1F	AMCA52-2R510G-S1F-T	Active	EOL
R0375	https://abracon.com/downloads/ECN-PCN/7020-ECN-EOL-R0375.pdf	Abracon	PRO-EX-251	PRO-EX-251	Active	EOL
R0375	https://abracon.com/downloads/ECN-PCN/7020-ECN-EOL-R0375.pdf	Abracon	APAMPSLJ-140	APAMPSLJ-140	Active	EOL
R0375	https://abracon.com/downloads/ECN-PCN/7020-ECN-EOL-R0375.pdf	Abracon	APAMS-119	APAMS-119	Active	EOL
R0376	https://abracon.com/downloads/ECN-PCN/7020-ECN-EOL-R0376.pdf	Abracon	PRO-EX-321	PRO-EX-321	Active	EOL
R0376	https://abracon.com/downloads/ECN-PCN/7020-ECN-EOL-R0376.pdf	Abracon	AEACAC198013-S5GNR	AEACAC198013-S5GNR	Active	EOL
R0377	https://abracon.com/downloads/ECN-PCN/7020-ECN-EOL-R0377.pdf	Abracon	AEACAC254010-S169	AEACAC254010-S169	Active	EOL
R0377	https://abracon.com/downloads/ECN-PCN/7020-ECN-EOL-R0377.pdf	Abracon	APAMSTJ-138	APAMSTJ-138	Active	EOL
R0378	https://abracon.com/downloads/ECN-PCN/7020-ECN-EOL-R0378.pdf	Abracon	AFS433.92N01	AFS433.92N01-SD02	Active	EOL
R0378	https://abracon.com/downloads/ECN-PCN/7020-ECN-EOL-R0378.pdf	Abracon	AFS446.0W02	AFS446.0W02-TD01	Active	EOL
R0378	https://abracon.com/downloads/ECN-PCN/7020-ECN-EOL-R0378.pdf	Abracon	AFS465.0W08	AFS465.0W08-TS4	Active	EOL
R0378	https://abracon.com/downloads/ECN-PCN/7020-ECN-EOL-R0378.pdf	Abracon	ASR433.92S53	ASR433.92S53	Active	EOL
R0379	https://abracon.com/downloads/ECN-PCN/7020-ECN-EOL-R0379.pdf	Abracon	AEACBA045015-S2332	AEACBA045015-S2332	Active	EOL
R0379	https://abracon.com/downloads/ECN-PCN/7020-ECN-EOL-R0379.pdf	Abracon	AEACBD050018-SG3	AEACBD050018-SG3	Active	EOL
R0379	https://abracon.com/downloads/ECN-PCN/7020-ECN-EOL-R0379.pdf	Abracon	APAMP-108	APAMP-108	Active	EOL
R0380	https://abracon.com/downloads/ECN-PCN/7020-ECN-EOL-R0380.pdf	Abracon	APAMP-110	APAMP-110	Active	EOL
R0380	https://abracon.com/downloads/ECN-PCN/7020-ECN-EOL-R0380.pdf	Abracon	APAMP-112	APAMP-112	Active	EOL
R0380	https://abracon.com/downloads/ECN-PCN/7020-ECN-EOL-R0380.pdf	Abracon	APAMP-124	APAMP-124	Active	EOL
R0381	https://abracon.com/downloads/ECN-PCN/7020-ECN-EOL-R0381.pdf	Abracon	APAMP-126	APAMP-126	Active	EOL
R0381	https://abracon.com/downloads/ECN-PCN/7020-ECN-EOL-R0381.pdf	Abracon	APAMPS-106	APAMPS-106	Active	EOL
R0381	https://abracon.com/downloads/ECN-PCN/7020-ECN-EOL-R0381.pdf	Abracon	APAMSJ-147	APAMSJ-147	Active	EOL
R0382	https://abracon.com/downloads/ECN-PCN/7020-ECN-EOL-R0382.pdf	Abracon	APAM1068JL01V2.0	APAM1068JL01V2.0	Active	EOL
R0382	https://abracon.com/downloads/ECN-PCN/7020-ECN-EOL-R0382.pdf	Abracon	APAM1268JL02V2.0	APAM1268JL02V2.0	Active	EOL
R0383	https://abracon.com/downloads/ECN-PCN/7020-ECN-EOL-R0383.pdf	Abracon	ARRAN5-868.000MHZ	ARRAN5-868.000MHZ	Active	EOL
R0383	https://abracon.com/downloads/ECN-PCN/7020-ECN-EOL-R0383.pdf	Abracon	ARRRN5-915.000MHZ	ARRRN5-915.000MHZ	Active	EOL
R0383	https://abracon.com/downloads/ECN-PCN/7020-ECN-EOL-R0383.pdf	Abracon	ARRSN5-915.000MHZ	ARRSN5-915.000MHZ	Active	EOL
R0384	https://abracon.com/downloads/ECN-PCN/7020-ECN-EOL-R0384.pdf	Abracon	ARRTN5-868.000MHZ	ARRTN5-868.000MHZ	Active	EOL
R0384	https://abracon.com/downloads/ECN-PCN/7020-ECN-EOL-R0384.pdf	Abracon	ART868X25275YZ25	ART868X25275YZ25	Active	EOL
R0384	https://abracon.com/downloads/ECN-PCN/7020-ECN-EOL-R0384.pdf	Abracon	ART915X100202TO-IC	ART915X100202TO-IC	Active	EOL
R0385	https://abracon.com/downloads/ECN-PCN/7020-ECN-EOL-R0385.pdf	Abracon	ART915X130930TX13-IC	ART915X130930TX13-IC	Active	EOL
R0385	https://abracon.com/downloads/ECN-PCN/7020-ECN-EOL-R0385.pdf	Abracon	ART915X1620TX16-IC	ART915X1620TX16-IC	Active	EOL
R0385	https://abracon.com/downloads/ECN-PCN/7020-ECN-EOL-R0385.pdf	Abracon	ART915X2117225TX21-IC	ART915X2117225TX21-IC	Active	EOL
R0386	https://abracon.com/downloads/ECN-PCN/7020-ECN-EOL-R0386.pdf	Abracon	ART915X250903AM-IC	ART915X250903AM-IC	Active	EOL
R0386	https://abracon.com/downloads/ECN-PCN/7020-ECN-EOL-R0386.pdf	Abracon	ART915X2509EP60-IC	ART915X2509EP60-IC	Active	EOL
R0386	https://abracon.com/downloads/ECN-PCN/7020-ECN-EOL-R0386.pdf	Abracon	ART915X252503MA-IC	ART915X252503MA-IC	Active	EOL
R0387	https://abracon.com/downloads/ECN-PCN/7020-ECN-EOL-R0387.pdf	Abracon	ART915X25275YZ25	ART915X25275YZ25	Active	EOL
R0387	https://abracon.com/downloads/ECN-PCN/7020-ECN-EOL-R0387.pdf	Abracon	ART915X25275YZ25-IC	ART915X25275YZ25-IC	Active	EOL
R0387	https://abracon.com/downloads/ECN-PCN/7020-ECN-EOL-R0387.pdf	Abracon	ART915X3030YZ30-IC	ART915X3030YZ30-IC	Active	EOL
R0388	https://abracon.com/downloads/ECN-PCN/7020-ECN-EOL-R0388.pdf	Abracon	ART923X1015YZ10	ART923X1015YZ10	Active	EOL
R0388	https://abracon.com/downloads/ECN-PCN/7020-ECN-EOL-R0388.pdf	Abracon	ART923X1015YZ10-IC	ART923X1015YZ10-IC	Active	EOL
R0388	https://abracon.com/downloads/ECN-PCN/7020-ECN-EOL-R0388.pdf	Abracon	APAKM4012-C2G3D	APAKM4012-C2G3D	Active	EOL
R0389	https://abracon.com/downloads/ECN-PCN/7020-ECN-EOL-R0389.pdf	Abracon	AFAC120050-U6G	AFAC120050-U6G	Active	EOL
R0389	https://abracon.com/downloads/ECN-PCN/7020-ECN-EOL-R0389.pdf	Abracon	AFAC240020-M698	AFAC240020-M698	Active	EOL







4965	<a href="https://abracon.com/downloads/ECN-PCN/7020-ECN-EOL-4965-ABNM.pdf">https://abracon.com/downloads/ECN-PCN/7020-ECN-EOL-4965-ABNM.pdf</a>	Abracon	ABNM	ABNM2-155.520MHZ-C	Active	EOL
4965	<a href="https://abracon.com/downloads/ECN-PCN/7020-ECN-EOL-4965-ABNM.pdf">https://abracon.com/downloads/ECN-PCN/7020-ECN-EOL-4965-ABNM.pdf</a>	Abracon	ABNM	ABNM-25.000MHZ-NR-P1	Active	EOL
4965	<a href="https://abracon.com/downloads/ECN-PCN/7020-ECN-EOL-4965-ABNM.pdf">https://abracon.com/downloads/ECN-PCN/7020-ECN-EOL-4965-ABNM.pdf</a>	Abracon	ABNM	ABNM-49.152MHZ-C-T	Active	EOL
4965	<a href="https://abracon.com/downloads/ECN-PCN/7020-ECN-EOL-4965-ABNM.pdf">https://abracon.com/downloads/ECN-PCN/7020-ECN-EOL-4965-ABNM.pdf</a>	Abracon	ABNM	ABNM-50.000MHZ-LR-C	Active	EOL
4965	<a href="https://abracon.com/downloads/ECN-PCN/7020-ECN-EOL-4965-ABNM.pdf">https://abracon.com/downloads/ECN-PCN/7020-ECN-EOL-4965-ABNM.pdf</a>	Abracon	ABNM	ABNM-50.000MHZ-LR-C-T	Active	EOL
4966	<a href="https://abracon.com/downloads/ECN-PCN/7020-ECN-EOL-4966-AB-RTCMC-32.768KHZ-B5GA-S3.pdf">https://abracon.com/downloads/ECN-PCN/7020-ECN-EOL-4966-AB-RTCMC-32.768KHZ-B5GA-S3.pdf</a>	Abracon	AB-RTCMC-32.768KHZ-B5GA-S3	AB-RTCMC-32.768KHZ-B5GA-S3	Active	EOL
4966	<a href="https://abracon.com/downloads/ECN-PCN/7020-ECN-EOL-4966-AB-RTCMC-32.768KHZ-B5GA-S3.pdf">https://abracon.com/downloads/ECN-PCN/7020-ECN-EOL-4966-AB-RTCMC-32.768KHZ-B5GA-S3.pdf</a>	Abracon	AB-RTCMC-32.768KHZ-B5GA-S3	AB-RTCMC-32.768KHZ-B5GA-S3-T	Active	EOL
4967	<a href="https://abracon.com/downloads/ECN-PCN/7020-ECN-EOL-4967-AB-RTCMC-32.768KHZ-ZIZE-S2.pdf">https://abracon.com/downloads/ECN-PCN/7020-ECN-EOL-4967-AB-RTCMC-32.768KHZ-ZIZE-S2.pdf</a>	Abracon	AB-RTCMC-32.768KHZ-ZIZE-S2	AB-RTCMC-32.768KHZ-ZIZE-S2-T	Active	EOL
4968	<a href="https://abracon.com/downloads/ECN-PCN/7020-ECN-EOL-4968-ALD.pdf">https://abracon.com/downloads/ECN-PCN/7020-ECN-EOL-4968-ALD.pdf</a>	Abracon	ALD	ALD-125.000MHZ-N-R-P	Active	EOL
4968	<a href="https://abracon.com/downloads/ECN-PCN/7020-ECN-EOL-4968-ALD.pdf">https://abracon.com/downloads/ECN-PCN/7020-ECN-EOL-4968-ALD.pdf</a>	Abracon	ALD	ALD-125.000MHZ-N-R-P-T	Active	EOL
4968	<a href="https://abracon.com/downloads/ECN-PCN/7020-ECN-EOL-4968-ALD.pdf">https://abracon.com/downloads/ECN-PCN/7020-ECN-EOL-4968-ALD.pdf</a>	Abracon	ALD	ALD-20.000MHZ-L-R-V-A-T	Active	EOL
4968	<a href="https://abracon.com/downloads/ECN-PCN/7020-ECN-EOL-4968-ALD.pdf">https://abracon.com/downloads/ECN-PCN/7020-ECN-EOL-4968-ALD.pdf</a>	Abracon	ALD	ALD-200.000MHZ-E-V	Active	EOL
4968	<a href="https://abracon.com/downloads/ECN-PCN/7020-ECN-EOL-4968-ALD.pdf">https://abracon.com/downloads/ECN-PCN/7020-ECN-EOL-4968-ALD.pdf</a>	Abracon	ALD	ALD-200.000MHZ-E-V-T	Active	EOL
4968	<a href="https://abracon.com/downloads/ECN-PCN/7020-ECN-EOL-4968-ALD.pdf">https://abracon.com/downloads/ECN-PCN/7020-ECN-EOL-4968-ALD.pdf</a>	Abracon	ALD	ALD-28.900MHZ-ERP1	Active	EOL
4968	<a href="https://abracon.com/downloads/ECN-PCN/7020-ECN-EOL-4968-ALD.pdf">https://abracon.com/downloads/ECN-PCN/7020-ECN-EOL-4968-ALD.pdf</a>	Abracon	ALD	ALD-32.000MHZ-L-P-A-T	Active	EOL
4968	<a href="https://abracon.com/downloads/ECN-PCN/7020-ECN-EOL-4968-ALD.pdf">https://abracon.com/downloads/ECN-PCN/7020-ECN-EOL-4968-ALD.pdf</a>	Abracon	ALD	ALD-49.152MHZ-C-T	Active	EOL
4968	<a href="https://abracon.com/downloads/ECN-PCN/7020-ECN-EOL-4968-ALD.pdf">https://abracon.com/downloads/ECN-PCN/7020-ECN-EOL-4968-ALD.pdf</a>	Abracon	ALD	ALD-83.000MHZ-LC-T	Active	EOL
4969	<a href="https://abracon.com/downloads/ECN-PCN/7020-ECN-EOL-4969-ALVD.pdf">https://abracon.com/downloads/ECN-PCN/7020-ECN-EOL-4969-ALVD.pdf</a>	Abracon	ALVD	ALVD-160.000MHZ-L-H-V-N100-T	Active	EOL
4969	<a href="https://abracon.com/downloads/ECN-PCN/7020-ECN-EOL-4969-ALVD.pdf">https://abracon.com/downloads/ECN-PCN/7020-ECN-EOL-4969-ALVD.pdf</a>	Abracon	ALVD	ALVD-250.000MHZ-D-H-C-N100	Active	EOL
4969	<a href="https://abracon.com/downloads/ECN-PCN/7020-ECN-EOL-4969-ALVD.pdf">https://abracon.com/downloads/ECN-PCN/7020-ECN-EOL-4969-ALVD.pdf</a>	Abracon	ALVD	ALVD-27.1200MHZ-L-R-C-N100	Active	EOL
4969	<a href="https://abracon.com/downloads/ECN-PCN/7020-ECN-EOL-4969-ALVD.pdf">https://abracon.com/downloads/ECN-PCN/7020-ECN-EOL-4969-ALVD.pdf</a>	Abracon	ALVD	ALVD-27.1200MHZ-L-R-C-N100-T	Active	EOL
4969	<a href="https://abracon.com/downloads/ECN-PCN/7020-ECN-EOL-4969-ALVD.pdf">https://abracon.com/downloads/ECN-PCN/7020-ECN-EOL-4969-ALVD.pdf</a>	Abracon	ALVD	ALVD-50.000MHZ-N-K-V-N100	Active	EOL
4969	<a href="https://abracon.com/downloads/ECN-PCN/7020-ECN-EOL-4969-ALVD.pdf">https://abracon.com/downloads/ECN-PCN/7020-ECN-EOL-4969-ALVD.pdf</a>	Abracon	ALVD	ALVD-61.440MHZ-LRC	Active	EOL
4970	<a href="https://abracon.com/downloads/ECN-PCN/7020-ECN-EOL-4970-AOCJY5.pdf">https://abracon.com/downloads/ECN-PCN/7020-ECN-EOL-4970-AOCJY5.pdf</a>	Abracon	AOCJY5	AOCJY5-10.000MHZ	Active	EOL
4971	<a href="https://abracon.com/downloads/ECN-PCN/7020-ECN-EOL-4971-AP5S.pdf">https://abracon.com/downloads/ECN-PCN/7020-ECN-EOL-4971-AP5S.pdf</a>	Abracon	AP5S	AP5S-125.000MHZ-LC	Active	EOL
4971	<a href="https://abracon.com/downloads/ECN-PCN/7020-ECN-EOL-4971-AP5S.pdf">https://abracon.com/downloads/ECN-PCN/7020-ECN-EOL-4971-AP5S.pdf</a>	Abracon	AP5S	AP5S-125.000MHZ-LC-T	Active	EOL
4971	<a href="https://abracon.com/downloads/ECN-PCN/7020-ECN-EOL-4971-AP5S.pdf">https://abracon.com/downloads/ECN-PCN/7020-ECN-EOL-4971-AP5S.pdf</a>	Abracon	AP5S	AP5S-15.280MHZ-IJ	Active	EOL
4971	<a href="https://abracon.com/downloads/ECN-PCN/7020-ECN-EOL-4971-AP5S.pdf">https://abracon.com/downloads/ECN-PCN/7020-ECN-EOL-4971-AP5S.pdf</a>	Abracon	AP5S	AP5S-200.000MHZ-DC	Active	EOL
4971	<a href="https://abracon.com/downloads/ECN-PCN/7020-ECN-EOL-4971-AP5S.pdf">https://abracon.com/downloads/ECN-PCN/7020-ECN-EOL-4971-AP5S.pdf</a>	Abracon	AP5S	AP5S-200.000MHZ-LR	Active	EOL
4971	<a href="https://abracon.com/downloads/ECN-PCN/7020-ECN-EOL-4971-AP5S.pdf">https://abracon.com/downloads/ECN-PCN/7020-ECN-EOL-4971-AP5S.pdf</a>	Abracon	AP5S	AP5S-28.636MHZ-LR	Active	EOL
4971	<a href="https://abracon.com/downloads/ECN-PCN/7020-ECN-EOL-4971-AP5S.pdf">https://abracon.com/downloads/ECN-PCN/7020-ECN-EOL-4971-AP5S.pdf</a>	Abracon	AP5S	AP5S-33.333MHZ-LR	Active	EOL
4971	<a href="https://abracon.com/downloads/ECN-PCN/7020-ECN-EOL-4971-AP5S.pdf">https://abracon.com/downloads/ECN-PCN/7020-ECN-EOL-4971-AP5S.pdf</a>	Abracon	AP5S	AP5S-40.000MHZ-LC-T	Active	EOL
4971	<a href="https://abracon.com/downloads/ECN-PCN/7020-ECN-EOL-4971-AP5S.pdf">https://abracon.com/downloads/ECN-PCN/7020-ECN-EOL-4971-AP5S.pdf</a>	Abracon	AP5S	AP5S-50.000MHZ-L	Active	EOL
4972	<a href="https://abracon.com/downloads/ECN-PCN/7020-ECN-EOL-4972-ASF1.pdf">https://abracon.com/downloads/ECN-PCN/7020-ECN-EOL-4972-ASF1.pdf</a>	Abracon	ASF1	ASF1-1.6869MHZ-C-T	Active	EOL
4972	<a href="https://abracon.com/downloads/ECN-PCN/7020-ECN-EOL-4972-ASF1.pdf">https://abracon.com/downloads/ECN-PCN/7020-ECN-EOL-4972-ASF1.pdf</a>	Abracon	ASF1	ASF1-10.000MHZ-LCS	Active	EOL
4972	<a href="https://abracon.com/downloads/ECN-PCN/7020-ECN-EOL-4972-ASF1.pdf">https://abracon.com/downloads/ECN-PCN/7020-ECN-EOL-4972-ASF1.pdf</a>	Abracon	ASF1	ASF1-11.2896MHZ-ERS-T	Active	EOL
4972	<a href="https://abracon.com/downloads/ECN-PCN/7020-ECN-EOL-4972-ASF1.pdf">https://abracon.com/downloads/ECN-PCN/7020-ECN-EOL-4972-ASF1.pdf</a>	Abracon	ASF1	ASF1-11.2896MHZ-E-R-S-T	Active	EOL
4972	<a href="https://abracon.com/downloads/ECN-PCN/7020-ECN-EOL-4972-ASF1.pdf">https://abracon.com/downloads/ECN-PCN/7020-ECN-EOL-4972-ASF1.pdf</a>	Abracon	ASF1	ASF1-12.000MHZ-LKS-T	Active	EOL
4972	<a href="https://abracon.com/downloads/ECN-PCN/7020-ECN-EOL-4972-ASF1.pdf">https://abracon.com/downloads/ECN-PCN/7020-ECN-EOL-4972-ASF1.pdf</a>	Abracon	ASF1	ASF1-13.560MHZ-FJ-T	Active	EOL
4972	<a href="https://abracon.com/downloads/ECN-PCN/7020-ECN-EOL-4972-ASF1.pdf">https://abracon.com/downloads/ECN-PCN/7020-ECN-EOL-4972-ASF1.pdf</a>	Abracon	ASF1	ASF1-16.000MHZ-NCS	Active	EOL
4972	<a href="https://abracon.com/downloads/ECN-PCN/7020-ECN-EOL-4972-ASF1.pdf">https://abracon.com/downloads/ECN-PCN/7020-ECN-EOL-4972-ASF1.pdf</a>	Abracon	ASF1	ASF1-2.000MHZ-ECS-T	Active	EOL
4972	<a href="https://abracon.com/downloads/ECN-PCN/7020-ECN-EOL-4972-ASF1.pdf">https://abracon.com/downloads/ECN-PCN/7020-ECN-EOL-4972-ASF1.pdf</a>	Abracon	ASF1	ASF1-2.0480MHZ-E	Active	EOL
4972	<a href="https://abracon.com/downloads/ECN-PCN/7020-ECN-EOL-4972-ASF1.pdf">https://abracon.com/downloads/ECN-PCN/7020-ECN-EOL-4972-ASF1.pdf</a>	Abracon	ASF1	ASF1-2.450MHZ-L-C-S-T	Active	EOL
4972	<a href="https://abracon.com/downloads/ECN-PCN/7020-ECN-EOL-4972-ASF1.pdf">https://abracon.com/downloads/ECN-PCN/7020-ECN-EOL-4972-ASF1.pdf</a>	Abracon	ASF1	ASF1-20.000MHZ-LR-T	Active	EOL
4972	<a href="https://abracon.com/downloads/ECN-PCN/7020-ECN-EOL-4972-ASF1.pdf">https://abracon.com/downloads/ECN-PCN/7020-ECN-EOL-4972-ASF1.pdf</a>	Abracon	ASF1	ASF1-26.000MHZ-L-T	Active	EOL
4972	<a href="https://abracon.com/downloads/ECN-PCN/7020-ECN-EOL-4972-ASF1.pdf">https://abracon.com/downloads/ECN-PCN/7020-ECN-EOL-4972-ASF1.pdf</a>	Abracon	ASF1	ASF1-3.686MHZ-N-K-S	Active	EOL
4972	<a href="https://abracon.com/downloads/ECN-PCN/7020-ECN-EOL-4972-ASF1.pdf">https://abracon.com/downloads/ECN-PCN/7020-ECN-EOL-4972-ASF1.pdf</a>	Abracon	ASF1	ASF1-4.000MHZ-LCS	Active	EOL
4972	<a href="https://abracon.com/downloads/ECN-PCN/7020-ECN-EOL-4972-ASF1.pdf">https://abracon.com/downloads/ECN-PCN/7020-ECN-EOL-4972-ASF1.pdf</a>	Abracon	ASF1	ASF1-4.000MHZ-LCS-T	Active	EOL
4972	<a href="https://abracon.com/downloads/ECN-PCN/7020-ECN-EOL-4972-ASF1.pdf">https://abracon.com/downloads/ECN-PCN/7020-ECN-EOL-4972-ASF1.pdf</a>	Abracon	ASF1	ASF1-48.000MHZ-NK-T	Active	EOL
4972	<a href="https://abracon.com/downloads/ECN-PCN/7020-ECN-EOL-4972-ASF1.pdf">https://abracon.com/downloads/ECN-PCN/7020-ECN-EOL-4972-ASF1.pdf</a>	Abracon	ASF1	ASF1-6.250MHZ-E	Active	EOL
4972	<a href="https://abracon.com/downloads/ECN-PCN/7020-ECN-EOL-4972-ASF1.pdf">https://abracon.com/downloads/ECN-PCN/7020-ECN-EOL-4972-ASF1.pdf</a>	Abracon	ASF1	ASF1-64.000MHZ-ECS-T	Active	EOL
4972	<a href="https://abracon.com/downloads/ECN-PCN/7020-ECN-EOL-4972-ASF1.pdf">https://abracon.com/downloads/ECN-PCN/7020-ECN-EOL-4972-ASF1.pdf</a>	Abracon	ASF1	ASF1-81.360MHZ-LC-T	Active	EOL
4973	<a href="https://abracon.com/downloads/ECN-PCN/7020-ECN-EOL-4973-ASG-C.pdf">https://abracon.com/downloads/ECN-PCN/7020-ECN-EOL-4973-ASG-C.pdf</a>	Abracon	ASG-C	ASG-C-V-A-10.000MHZ	Active	EOL



























4947	<a href="https://abracon.com/downloads/ECN-PCN/7020-ECN-EOL-4947-2nd-Round-Standard-Series.pdf">https://abracon.com/downloads/ECN-PCN/7020-ECN-EOL-4947-2nd-Round-Standard-Series.pdf</a>	Oscilent	430	430-64.0M-5EZ-TS-TR	Active	EOL
4947	<a href="https://abracon.com/downloads/ECN-PCN/7020-ECN-EOL-4947-2nd-Round-Standard-Series.pdf">https://abracon.com/downloads/ECN-PCN/7020-ECN-EOL-4947-2nd-Round-Standard-Series.pdf</a>	Oscilent	430	430-1.8432M-3F-NC	Active	EOL
4947	<a href="https://abracon.com/downloads/ECN-PCN/7020-ECN-EOL-4947-2nd-Round-Standard-Series.pdf">https://abracon.com/downloads/ECN-PCN/7020-ECN-EOL-4947-2nd-Round-Standard-Series.pdf</a>	Oscilent	430	430-16.0M-5DN-TS-TR	Active	EOL
4947	<a href="https://abracon.com/downloads/ECN-PCN/7020-ECN-EOL-4947-2nd-Round-Standard-Series.pdf">https://abracon.com/downloads/ECN-PCN/7020-ECN-EOL-4947-2nd-Round-Standard-Series.pdf</a>	Oscilent	430	430-1.8342M-3F-NC	Active	EOL
4947	<a href="https://abracon.com/downloads/ECN-PCN/7020-ECN-EOL-4947-2nd-Round-Standard-Series.pdf">https://abracon.com/downloads/ECN-PCN/7020-ECN-EOL-4947-2nd-Round-Standard-Series.pdf</a>	Oscilent	512	512-9.216M-510C-NC	Active	EOL
4947	<a href="https://abracon.com/downloads/ECN-PCN/7020-ECN-EOL-4947-2nd-Round-Standard-Series.pdf">https://abracon.com/downloads/ECN-PCN/7020-ECN-EOL-4947-2nd-Round-Standard-Series.pdf</a>	Oscilent	512	512-10.0M-325D-NC	Active	EOL
4947	<a href="https://abracon.com/downloads/ECN-PCN/7020-ECN-EOL-4947-2nd-Round-Standard-Series.pdf">https://abracon.com/downloads/ECN-PCN/7020-ECN-EOL-4947-2nd-Round-Standard-Series.pdf</a>	Oscilent	522	522-100.0M-350A-NC	Active	EOL
4947	<a href="https://abracon.com/downloads/ECN-PCN/7020-ECN-EOL-4947-2nd-Round-Standard-Series.pdf">https://abracon.com/downloads/ECN-PCN/7020-ECN-EOL-4947-2nd-Round-Standard-Series.pdf</a>	Oscilent	673	673-25.6M-TR	Active	EOL
4947	<a href="https://abracon.com/downloads/ECN-PCN/7020-ECN-EOL-4947-2nd-Round-Standard-Series.pdf">https://abracon.com/downloads/ECN-PCN/7020-ECN-EOL-4947-2nd-Round-Standard-Series.pdf</a>	Oscilent	673	673-11.06M-TR	Active	EOL
4947	<a href="https://abracon.com/downloads/ECN-PCN/7020-ECN-EOL-4947-2nd-Round-Standard-Series.pdf">https://abracon.com/downloads/ECN-PCN/7020-ECN-EOL-4947-2nd-Round-Standard-Series.pdf</a>	Oscilent	673	673-11.06M-30-TR	Active	EOL
4947	<a href="https://abracon.com/downloads/ECN-PCN/7020-ECN-EOL-4947-2nd-Round-Standard-Series.pdf">https://abracon.com/downloads/ECN-PCN/7020-ECN-EOL-4947-2nd-Round-Standard-Series.pdf</a>	Oscilent	673	673-10.0M-TR	Active	EOL
4947	<a href="https://abracon.com/downloads/ECN-PCN/7020-ECN-EOL-4947-2nd-Round-Standard-Series.pdf">https://abracon.com/downloads/ECN-PCN/7020-ECN-EOL-4947-2nd-Round-Standard-Series.pdf</a>	Oscilent	675	675-20.0M-10-03	Active	EOL
4947	<a href="https://abracon.com/downloads/ECN-PCN/7020-ECN-EOL-4947-2nd-Round-Standard-Series.pdf">https://abracon.com/downloads/ECN-PCN/7020-ECN-EOL-4947-2nd-Round-Standard-Series.pdf</a>	Oscilent	675	675-20.0M-10-03-TR	Active	EOL
4947	<a href="https://abracon.com/downloads/ECN-PCN/7020-ECN-EOL-4947-2nd-Round-Standard-Series.pdf">https://abracon.com/downloads/ECN-PCN/7020-ECN-EOL-4947-2nd-Round-Standard-Series.pdf</a>	Oscilent	675	675-16.0M-15	Active	EOL
4947	<a href="https://abracon.com/downloads/ECN-PCN/7020-ECN-EOL-4947-2nd-Round-Standard-Series.pdf">https://abracon.com/downloads/ECN-PCN/7020-ECN-EOL-4947-2nd-Round-Standard-Series.pdf</a>	Oscilent	675	675-18.0M-15	Active	EOL
4961	<a href="https://abracon.com/downloads/ECN-PCN/7020-ECN-EOL-4961-ABM3AIG.pdf">https://abracon.com/downloads/ECN-PCN/7020-ECN-EOL-4961-ABM3AIG.pdf</a>	Abracon	ABM3AIG	ABM3AIG-40.000MHZ-10-KR-T	Active	EOL
4962	<a href="https://abracon.com/downloads/ECN-PCN/7020-ECN-EOL-4962-ABM9.pdf">https://abracon.com/downloads/ECN-PCN/7020-ECN-EOL-4962-ABM9.pdf</a>	Abracon	ABM9	ABM9-25.000MHZ-20-R50-B4Y-T	Active	EOL
4964	<a href="https://abracon.com/downloads/ECN-PCN/7020-ECN-EOL-4964-ABMM1.pdf">https://abracon.com/downloads/ECN-PCN/7020-ECN-EOL-4964-ABMM1.pdf</a>	Abracon	ABMM1	ABMM1-10.000MHZ-18-R60-E4H-F-T	Active	EOL
4971	<a href="https://abracon.com/downloads/ECN-PCN/7020-ECN-EOL-4971-AP5S.pdf">https://abracon.com/downloads/ECN-PCN/7020-ECN-EOL-4971-AP5S.pdf</a>	Abracon	AP5S	AP5SB-LR-T (BLANKS)	Active	EOL
4971	<a href="https://abracon.com/downloads/ECN-PCN/7020-ECN-EOL-4971-AP5S.pdf">https://abracon.com/downloads/ECN-PCN/7020-ECN-EOL-4971-AP5S.pdf</a>	Abracon	AP5S	AP5S-10.000MHZ-LC-T	Active	EOL
4971	<a href="https://abracon.com/downloads/ECN-PCN/7020-ECN-EOL-4971-AP5S.pdf">https://abracon.com/downloads/ECN-PCN/7020-ECN-EOL-4971-AP5S.pdf</a>	Abracon	AP5S	AP5S1-166.000MHZ-LR	Active	EOL
4971	<a href="https://abracon.com/downloads/ECN-PCN/7020-ECN-EOL-4971-AP5S.pdf">https://abracon.com/downloads/ECN-PCN/7020-ECN-EOL-4971-AP5S.pdf</a>	Abracon	AP5S	AP5S-10.000MHZ-LC	Active	EOL
4973	<a href="https://abracon.com/downloads/ECN-PCN/7020-ECN-EOL-4973-ASG-C.pdf">https://abracon.com/downloads/ECN-PCN/7020-ECN-EOL-4973-ASG-C.pdf</a>	Abracon	ASG-C	ASG-C-V-A-156.250MHZ	Active	EOL
4973	<a href="https://abracon.com/downloads/ECN-PCN/7020-ECN-EOL-4973-ASG-C.pdf">https://abracon.com/downloads/ECN-PCN/7020-ECN-EOL-4973-ASG-C.pdf</a>	Abracon	ASG-C	ASG-C-V-A-156.250MHZ-T	Active	EOL
4984	<a href="https://abracon.com/downloads/ECN-PCN/7020-ECN-EOL-4984-ASV1.pdf">https://abracon.com/downloads/ECN-PCN/7020-ECN-EOL-4984-ASV1.pdf</a>	Abracon	ASV1	ASV1-24.000MHZ-R-T	Active	EOL
4947	<a href="https://abracon.com/downloads/ECN-PCN/7020-ECN-EOL-4947-2nd-Round-Standard-Series.pdf">https://abracon.com/downloads/ECN-PCN/7020-ECN-EOL-4947-2nd-Round-Standard-Series.pdf</a>	MMD	B	MMC-177F-6.7458MHZ	Active	EOL
4947	<a href="https://abracon.com/downloads/ECN-PCN/7020-ECN-EOL-4947-2nd-Round-Standard-Series.pdf">https://abracon.com/downloads/ECN-PCN/7020-ECN-EOL-4947-2nd-Round-Standard-Series.pdf</a>	MMD	B	BF18BA1-28.322MHZ	Active	EOL
4947	<a href="https://abracon.com/downloads/ECN-PCN/7020-ECN-EOL-4947-2nd-Round-Standard-Series.pdf">https://abracon.com/downloads/ECN-PCN/7020-ECN-EOL-4947-2nd-Round-Standard-Series.pdf</a>	MMD	B	BF20BA1-3.6864MHZ-I	Active	EOL
4947	<a href="https://abracon.com/downloads/ECN-PCN/7020-ECN-EOL-4947-2nd-Round-Standard-Series.pdf">https://abracon.com/downloads/ECN-PCN/7020-ECN-EOL-4947-2nd-Round-Standard-Series.pdf</a>	MMD	B	BF22BC1-32.000MHZ	Active	EOL
4947	<a href="https://abracon.com/downloads/ECN-PCN/7020-ECN-EOL-4947-2nd-Round-Standard-Series.pdf">https://abracon.com/downloads/ECN-PCN/7020-ECN-EOL-4947-2nd-Round-Standard-Series.pdf</a>	MMD	B	BF20BA1-4.000MHZ	Active	EOL
4947	<a href="https://abracon.com/downloads/ECN-PCN/7020-ECN-EOL-4947-2nd-Round-Standard-Series.pdf">https://abracon.com/downloads/ECN-PCN/7020-ECN-EOL-4947-2nd-Round-Standard-Series.pdf</a>	MMD	B	BF22BC1-29.4912MHZ	Active	EOL
4947	<a href="https://abracon.com/downloads/ECN-PCN/7020-ECN-EOL-4947-2nd-Round-Standard-Series.pdf">https://abracon.com/downloads/ECN-PCN/7020-ECN-EOL-4947-2nd-Round-Standard-Series.pdf</a>	MMD	B	BF20BA1-20.000MHZ	Active	EOL
4947	<a href="https://abracon.com/downloads/ECN-PCN/7020-ECN-EOL-4947-2nd-Round-Standard-Series.pdf">https://abracon.com/downloads/ECN-PCN/7020-ECN-EOL-4947-2nd-Round-Standard-Series.pdf</a>	MMD	B	BF20BA1-25.000MHZ	Active	EOL
4947	<a href="https://abracon.com/downloads/ECN-PCN/7020-ECN-EOL-4947-2nd-Round-Standard-Series.pdf">https://abracon.com/downloads/ECN-PCN/7020-ECN-EOL-4947-2nd-Round-Standard-Series.pdf</a>	MMD	B	BF20BA1-16.000MHZ	Active	EOL
4947	<a href="https://abracon.com/downloads/ECN-PCN/7020-ECN-EOL-4947-2nd-Round-Standard-Series.pdf">https://abracon.com/downloads/ECN-PCN/7020-ECN-EOL-4947-2nd-Round-Standard-Series.pdf</a>	MMD	B	BF20BA1-18.432MHZ	Active	EOL
4947	<a href="https://abracon.com/downloads/ECN-PCN/7020-ECN-EOL-4947-2nd-Round-Standard-Series.pdf">https://abracon.com/downloads/ECN-PCN/7020-ECN-EOL-4947-2nd-Round-Standard-Series.pdf</a>	MMD	B	BF16BB1-16.000MHZ	Active	EOL
4947	<a href="https://abracon.com/downloads/ECN-PCN/7020-ECN-EOL-4947-2nd-Round-Standard-Series.pdf">https://abracon.com/downloads/ECN-PCN/7020-ECN-EOL-4947-2nd-Round-Standard-Series.pdf</a>	MMD	B	BF20BA1-14.31818MHZ	Active	EOL
4947	<a href="https://abracon.com/downloads/ECN-PCN/7020-ECN-EOL-4947-2nd-Round-Standard-Series.pdf">https://abracon.com/downloads/ECN-PCN/7020-ECN-EOL-4947-2nd-Round-Standard-Series.pdf</a>	MMD	B	BF10CA3-54.000MHZ	Active	EOL
4947	<a href="https://abracon.com/downloads/ECN-PCN/7020-ECN-EOL-4947-2nd-Round-Standard-Series.pdf">https://abracon.com/downloads/ECN-PCN/7020-ECN-EOL-4947-2nd-Round-Standard-Series.pdf</a>	Ecliptek	E1U	E1UHA27-7.3728M TR	Active	EOL
4947	<a href="https://abracon.com/downloads/ECN-PCN/7020-ECN-EOL-4947-2nd-Round-Standard-Series.pdf">https://abracon.com/downloads/ECN-PCN/7020-ECN-EOL-4947-2nd-Round-Standard-Series.pdf</a>	Ecliptek	E1U	E1UPA16-9.8304MTR	Active	EOL
4947	<a href="https://abracon.com/downloads/ECN-PCN/7020-ECN-EOL-4947-2nd-Round-Standard-Series.pdf">https://abracon.com/downloads/ECN-PCN/7020-ECN-EOL-4947-2nd-Round-Standard-Series.pdf</a>	Ecliptek	E1U	E1UFA16-7.000M	Active	EOL
4947	<a href="https://abracon.com/downloads/ECN-PCN/7020-ECN-EOL-4947-2nd-Round-Standard-Series.pdf">https://abracon.com/downloads/ECN-PCN/7020-ECN-EOL-4947-2nd-Round-Standard-Series.pdf</a>	Ecliptek	E1U	E1UEA20-4.000M	Active	EOL
4947	<a href="https://abracon.com/downloads/ECN-PCN/7020-ECN-EOL-4947-2nd-Round-Standard-Series.pdf">https://abracon.com/downloads/ECN-PCN/7020-ECN-EOL-4947-2nd-Round-Standard-Series.pdf</a>	Ecliptek	E1U	E1UAA20-24.576M	Active	EOL
4947	<a href="https://abracon.com/downloads/ECN-PCN/7020-ECN-EOL-4947-2nd-Round-Standard-Series.pdf">https://abracon.com/downloads/ECN-PCN/7020-ECN-EOL-4947-2nd-Round-Standard-Series.pdf</a>	Ecliptek	E1U	E1UAA20-8.889M	Active	EOL
4947	<a href="https://abracon.com/downloads/ECN-PCN/7020-ECN-EOL-4947-2nd-Round-Standard-Series.pdf">https://abracon.com/downloads/ECN-PCN/7020-ECN-EOL-4947-2nd-Round-Standard-Series.pdf</a>	Ecliptek	E1U	E1UDA18-7.3728M	Active	EOL
4947	<a href="https://abracon.com/downloads/ECN-PCN/7020-ECN-EOL-4947-2nd-Round-Standard-Series.pdf">https://abracon.com/downloads/ECN-PCN/7020-ECN-EOL-4947-2nd-Round-Standard-Series.pdf</a>	Ecliptek	E1U	E1UAA18-3.579545MHZ	Active	EOL
4947	<a href="https://abracon.com/downloads/ECN-PCN/7020-ECN-EOL-4947-2nd-Round-Standard-Series.pdf">https://abracon.com/downloads/ECN-PCN/7020-ECN-EOL-4947-2nd-Round-Standard-Series.pdf</a>	Ecliptek	E1U	E1UAA18-24.576M	Active	EOL
4947	<a href="https://abracon.com/downloads/ECN-PCN/7020-ECN-EOL-4947-2nd-Round-Standard-Series.pdf">https://abracon.com/downloads/ECN-PCN/7020-ECN-EOL-4947-2nd-Round-Standard-Series.pdf</a>	Ecliptek	E1U	E1UCA18-25.000M	Active	EOL
4947	<a href="https://abracon.com/downloads/ECN-PCN/7020-ECN-EOL-4947-2nd-Round-Standard-Series.pdf">https://abracon.com/downloads/ECN-PCN/7020-ECN-EOL-4947-2nd-Round-Standard-Series.pdf</a>	Ecliptek	E1U	E1UAA18-19.6608M TR	Active	EOL
4947	<a href="https://abracon.com/downloads/ECN-PCN/7020-ECN-EOL-4947-2nd-Round-Standard-Series.pdf">https://abracon.com/downloads/ECN-PCN/7020-ECN-EOL-4947-2nd-Round-Standard-Series.pdf</a>	Ecliptek	E1U	E1UAA18-8.000M	Active	EOL
4947	<a href="https://abracon.com/downloads/ECN-PCN/7020-ECN-EOL-4947-2nd-Round-Standard-Series.pdf">https://abracon.com/downloads/ECN-PCN/7020-ECN-EOL-4947-2nd-Round-Standard-Series.pdf</a>	Ecliptek	E1U	E1UAA20-8.8889M	Active	EOL
4947	<a href="https://abracon.com/downloads/ECN-PCN/7020-ECN-EOL-4947-2nd-Round-Standard-Series.pdf">https://abracon.com/downloads/ECN-PCN/7020-ECN-EOL-4947-2nd-Round-Standard-Series.pdf</a>	Ecliptek	E1U	E1UAA18-7.3728M	Active	EOL
4947	<a href="https://abracon.com/downloads/ECN-PCN/7020-ECN-EOL-4947-2nd-Round-Standard-Series.pdf">https://abracon.com/downloads/ECN-PCN/7020-ECN-EOL-4947-2nd-Round-Standard-Series.pdf</a>	Ecliptek	E1U	E1UAA18-3.6864M	Active	EOL



























M1656	<a href="https://abracon.com/downloads/ECN-PCN/ECN-EOL-M1656-ASPI-5040S-Notification.pdf">https://abracon.com/downloads/ECN-PCN/ECN-EOL-M1656-ASPI-5040S-Notification.pdf</a>	Abracon
M1656	<a href="https://abracon.com/downloads/ECN-PCN/ECN-EOL-M1656-ASPI-5040S-Notification.pdf">https://abracon.com/downloads/ECN-PCN/ECN-EOL-M1656-ASPI-5040S-Notification.pdf</a>	Abracon
M1656	<a href="https://abracon.com/downloads/ECN-PCN/ECN-EOL-M1656-ASPI-5040S-Notification.pdf">https://abracon.com/downloads/ECN-PCN/ECN-EOL-M1656-ASPI-5040S-Notification.pdf</a>	Abracon
M1656	<a href="https://abracon.com/downloads/ECN-PCN/ECN-EOL-M1656-ASPI-5040S-Notification.pdf">https://abracon.com/downloads/ECN-PCN/ECN-EOL-M1656-ASPI-5040S-Notification.pdf</a>	Abracon
M1656	<a href="https://abracon.com/downloads/ECN-PCN/ECN-EOL-M1656-ASPI-5040S-Notification.pdf">https://abracon.com/downloads/ECN-PCN/ECN-EOL-M1656-ASPI-5040S-Notification.pdf</a>	Abracon
M1656	<a href="https://abracon.com/downloads/ECN-PCN/ECN-EOL-M1656-ASPI-5040S-Notification.pdf">https://abracon.com/downloads/ECN-PCN/ECN-EOL-M1656-ASPI-5040S-Notification.pdf</a>	Abracon
M1656	<a href="https://abracon.com/downloads/ECN-PCN/ECN-EOL-M1656-ASPI-5040S-Notification.pdf">https://abracon.com/downloads/ECN-PCN/ECN-EOL-M1656-ASPI-5040S-Notification.pdf</a>	Abracon
M1656	<a href="https://abracon.com/downloads/ECN-PCN/ECN-EOL-M1656-ASPI-5040S-Notification.pdf">https://abracon.com/downloads/ECN-PCN/ECN-EOL-M1656-ASPI-5040S-Notification.pdf</a>	Abracon
M1656	<a href="https://abracon.com/downloads/ECN-PCN/ECN-EOL-M1656-ASPI-5040S-Notification.pdf">https://abracon.com/downloads/ECN-PCN/ECN-EOL-M1656-ASPI-5040S-Notification.pdf</a>	Abracon
M1656	<a href="https://abracon.com/downloads/ECN-PCN/ECN-EOL-M1656-ASPI-5040S-Notification.pdf">https://abracon.com/downloads/ECN-PCN/ECN-EOL-M1656-ASPI-5040S-Notification.pdf</a>	Abracon
M1656	<a href="https://abracon.com/downloads/ECN-PCN/ECN-EOL-M1656-ASPI-5040S-Notification.pdf">https://abracon.com/downloads/ECN-PCN/ECN-EOL-M1656-ASPI-5040S-Notification.pdf</a>	Abracon

ASPI-5040S	ASPI-5040S-470M-T	Active	EOL
ASPI-5040S	ASPI-5040S-330M	Active	EOL
ASPI-5040S	ASPI-5040S-3R3N	Active	EOL
ASPI-5040S	ASPI-5040S-2R2N	Active	EOL
ASPI-5040S	ASPI-5040S-100M	Active	EOL
ASPI-5040S	ASPI-8040HS-5R6M	Active	EOL
ASPI-5040S	ASPI-5040S-470M	Active	EOL
ASPI-5040S	ASPI-5040S-4R7N	Active	EOL
ASPI-5040S	ASPI-5040S-6R8M	Active	EOL
ASPI-5040S	ASPI-5040S-150M	Active	EOL
ASPI-5040S	ASPI-5040S-220M	Active	EOL
ASPI-5040S	ASPI-5040S-1R5N	Active	EOL