

Please make entry of a summary of Modification Notice.

<< REQUEST >>

There was modification of Product News 20250807_PDC_00004 of September 2025 issue.
What we have changed as follows;
The Product Code change date will remain unchanged in **April 2026**, but the specification modify date for new products, whose country of origin is Japan, will be changed to **August**.
Please abolish old edition, replace the latest.

NOTE:

This PCN is intended for use exclusively in **EUROPE, Middle East and Africa.**

[Target Products]

Miniature Power Relay
MY□-02 series and MY□F series, whose country of origin is China

[Effective Date]

Effective as Product Code and Country of origin in **April 2026**.
Effective as Specification of new product in **August 2026**.
*The effective date is subject to change due to the availability of parts and materials.
Thank you for your understanding in advance.

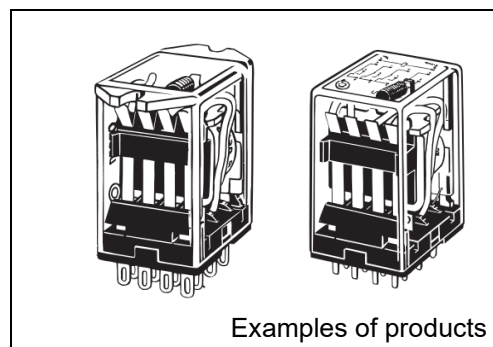

Examples of products

[Reason for change]

To improve or to change our production system

[Caution for New Products]

New products, whose country of origin is Japan, will be modified in **August 2026**.
On this notice, the specification of new product is described after modification.
Please refer to the Product News **20260302_PDC_00001** for details of the changes before and after the modifications of the new products.

[Difference from old Products]

New Products	Body Color	Dimensions	Wire connection	Mounting Dimensions	Characteristics	Operation ratings	Operation methods
MY□-02 series	--	--	**	**	*	**	**
MY□F series	--	**	**	**	*	**	**

** : Compatible

* : The change is a little/Almost compatible







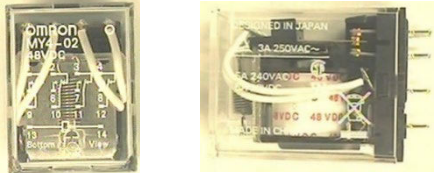

-- : Not compatible

- : No corresponding specification

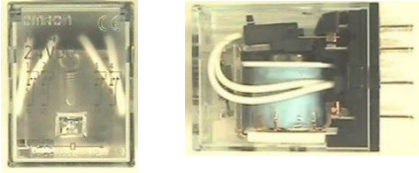
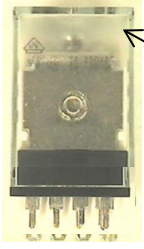
[Changes]

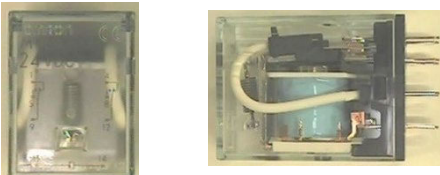
Old Products	Old Product Code	New Products	New Product Code
MY2-02-SL-EU AC220/240	MY206080C	MY2-02 AC220/240	MY201494A
MY2-02-US-SV AC220/240	MY206053F	MY2-02 AC220/240	MY201494A
MY2-02-US-SV DC24	MY206043R	MY2-02 DC24	MY201088A
MY2-02-US-SV-EU AC220/240	MY206077C	MY2-02 AC220/240	MY201494A
MY2-02-US-SV-EU DC24	MY206074R	MY2-02 DC24	MY201088A
MY4-02-EU AC220/240	MY406266H	MY4-02 AC220/240	MY401904E
MY4-02-EU DC24	MY406262E	MY4-02 DC24	MY401131A
MY2-02 AC100/110	MY206055B	MY2-02 AC100/110	MY201084R
MY2-02 AC200/220	MY206056M	MY2-02 AC200/220	MY201085G
MY2-02 AC200/220 /C	MY206067F	MY2-02 AC200/220	MY201085G
MY2-02 AC220/240	MY206051M	MY2-02 AC220/240	MY201494A
MY2-02 AC220/240 /C	MY206068D	MY2-02 AC220/240	MY201494A
MY2-02 AC24	MY206002A	MY2-02 AC24	MY201083M
MY2-02 DC12	MY206011M	MY2-02 DC12	MY201087C
MY2-02 DC24	MY206012R	MY2-02 DC24	MY201088A
MY2-02 DC48	MY206013G	MY2-02 DC48	MY201089M
MY4-02 AC110/120	MY406104A	MY4-02 AC110/120	MY401903G
MY4-02 AC220/240	MY406105M	MY4-02 AC220/240	MY401904E
MY4-02 AC24	MY406021E	MY4-02 AC24	MY401508B
MY4-02 DC12	MY406029M	MY4-02 DC12	MY401129M
MY4-02 DC24	MY406031B	MY4-02 DC24	MY401131A
MY2F-EU AC220/240	MY2 6195H	MY2F AC220/240	MY2 1760F
MY2F AC220/240	MY2 6049H	MY2F AC220/240	MY2 1760F

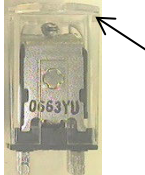
Before the change	After the change
【Country of origin】 China	【Country of origin】 Japan

Before the change	After the change
<p align="center">【Body Color】 MY□-02 series Body color (Case): clear Marking: White (Stamp) Marking position: Top and Side</p> <p align="center">MY4-02 series Top Side</p>  <p align="center">Back</p>  <p align="center">← Case</p>	<p align="center">【Body Color】 MY□-02 series Body color (Case): Light blue Marking: Black (Laser) Marking position: Top and Back</p> <p align="center">MY4-02 series Top Side</p>  <p align="center">Back</p>  <p align="center">← Case</p>
<p align="center">MY2-02 series Top Side</p>  <p align="center">Back</p>  <p align="center">← Case</p>	<p align="center">MY2-02 series Top Side</p>  <p align="center">Back</p>  <p align="center">← Case</p>
<p align="center">MY□F series Body color (Case): clear Marking: White (Stamp) Marking position: Side 1 and Side 2</p> <p align="center">Side 1 Top Side 2</p>  <p align="center">Back</p>  <p align="center">← Case</p>	<p align="center">MY□F series Body color (Case): Light blue Marking: Black (Laser) Marking position: Back</p> <p align="center">Side 1 Top Side 2</p>  <p align="center">Back</p>  <p align="center">← Case</p>

Before the change

[Dimension]
MY□-02 series

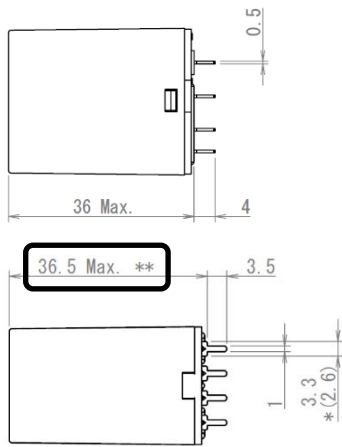

* Dimensions in parentheses are for the MY4-02.

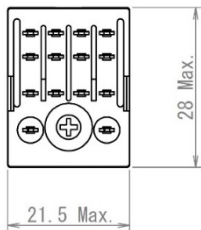

(Unit: mm)

After the change

[Dimension]
MY□-02 series

**The height dimension from the board surface.

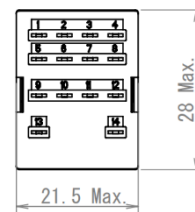
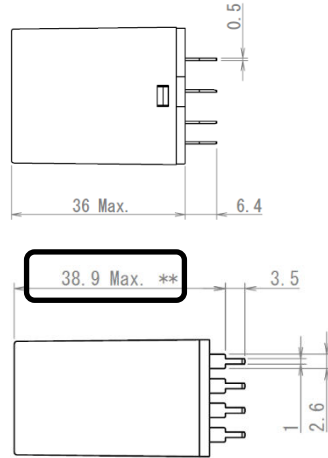

(Unit: mm)

MY□F series
No different

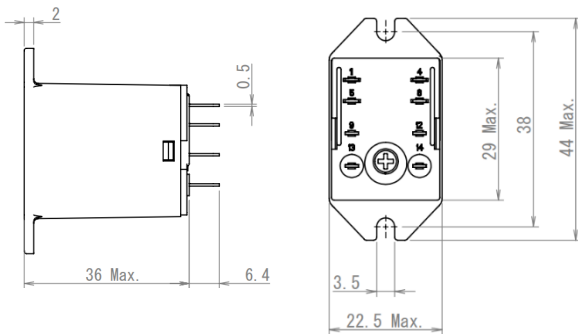
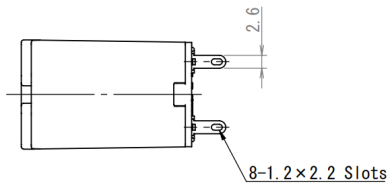

(Unit: mm)

MY□F series
No different

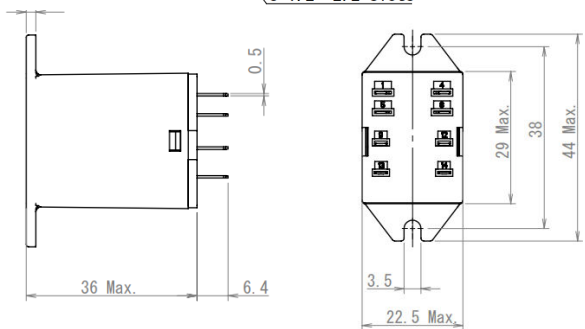
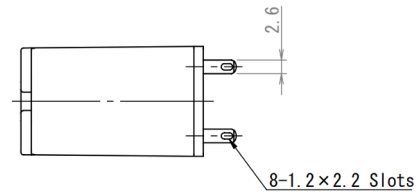

(Unit: mm)

Before the change

【Mounting dimension】

MY□-02 series
No different

MY2-02 series MY4-02 series

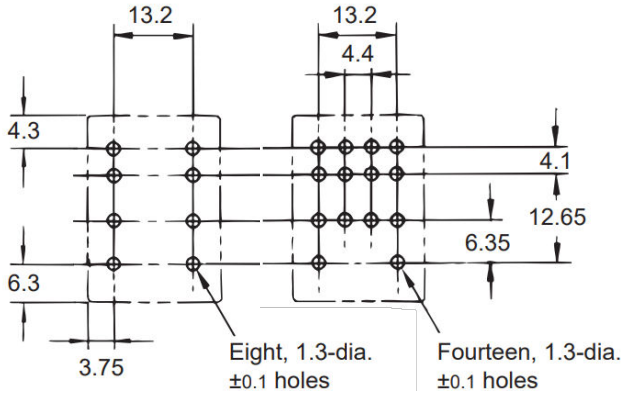

(Unit: mm)

MY□F series
No different

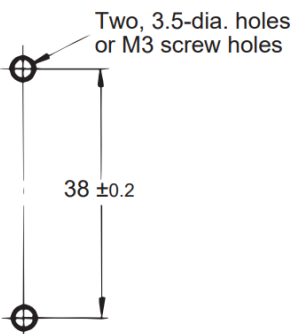

(Unit: mm)

【Lot No.】

Lot No position: Inside parts
Lot No 4 digits

Ex: 1 9 5 5
 Day Month Year

MY□-02 / MY□F series



After the change

【Mounting dimension】

MY□-02 series (Unit: mm)
No different

MY2-02 series MY4-02 series

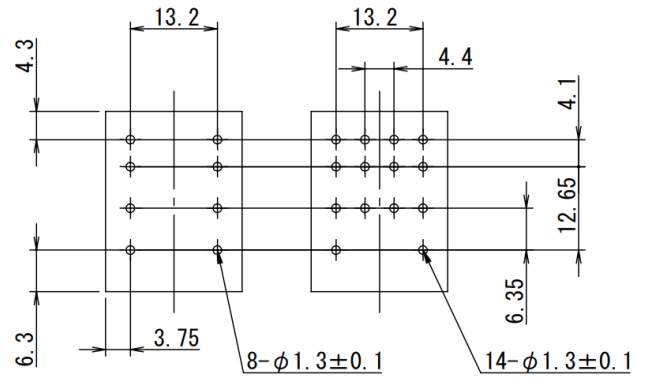

(Unit: mm)

MY□F series
No different

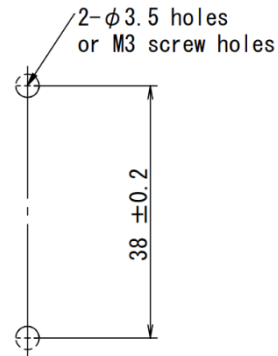

(Unit: mm)

【Lot No.】

Lot No position: Case
Lot No 5 digits

Ex: 1 9 5 25
 Day Month Year

MY□-02 series

MY□F series

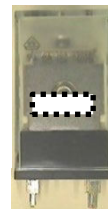

[Characteristics]
MY2-02 / MY2F series

Item	Before the change	After the change
Contact structure	Single	
Number of poles	2pole (DPDT)	
Contact material	Ag	
Rated load (Resistive load)	AC220V 5A DC24V 5A	
Rated load (Inductive load)	AC220V 2A (p.f. = 0.4) DC24V 2A (L/R 7 msec)	
Rated carry current	5A	
Maximum contact voltage	AC250 V DC125 V	
Maximum carry current	5A	
Maximum switching power (Resistive load)	1,100VA 120W	
Maximum switching power (Inductive load)	440 VA 48 W	
Contact resistance	50m Ohms max.	
Operation time	20 ms max.	
Release time	20 ms max.	
Mechanical Endurance	AC: 50,000,000 operation min. DC: 100,000,000 operation min. (18,000 operation/h)	
Electrical Endurance	500,000 operation min. (1,800 operation/h)	
Failure rate P value (Reference value)	DC5V 1mA	
Insulation resistance	100 M ohms min.	
Dielectric strength Between coil and contacts	2,000 VAC, 50/60Hz for 1min	
Dielectric strength Between contacts of different polarity	2,000 VAC, 50/60Hz for 1min	
Dielectric strength Between contacts of the same polarity	1,000 VAC, 50/60Hz for 1min	
Vibration resistance Destruction	10 to 55 to 10 Hz, 0.5mm single amplitude (1.0mm double amplitude)	
Vibration resistance Malfunction	10 to 55 to 10 Hz, 0.5mm single amplitude (1.0mm double amplitude)	
Shock resistance Destruction	1,000 m/s ²	
Shock resistance Malfunction	200 m/s ²	
Ambient operating temperature	-55 to 70 deg C	
Ambient operating humidity	5% to 85%	
Weight	Approx. 35 g	
*There are no change to the other specifications.		

[Characteristics] continue
MY4-02 series

Item	Before the change	After the change
Contact structure	Single	
Number of poles	4pole (4PDT)	
Contact material	Ag (Au plating)	Ag alloy (Au cladding)
Rated load (Resistive load)	AC220V 3A DC24V 3A	
Rated load (Inductive load)	AC220V 0.8A (p.f. = 0.4) DC24V 1.5A (L/R 7 msec)	
Rated carry current	3A	
Maximum contact voltage	AC250 V DC125 V	
Maximum carry current	3A	
Maximum switching power (Resistive load)	660VA 72W	
Maximum switching power (Inductive load)	176 VA 36 W	
Contact resistance	50m Ohms max.	
Operation time	20 ms max.	
Release time	20 ms max.	
Mechanical Endurance	AC: 50,000,000 operation min. DC: 100,000,000 operation min. (18,000 operation/h)	
Electrical Endurance	200,000 operation min. (1,800 operation/h)	
Failure rate P value (Reference value)	DC1V 1mA	
Insulation resistance	100 M ohms min.	
Dielectric strength Between coil and contacts	2,000 VAC, 50/60Hz for 1min	
Dielectric strength Between contacts of different polarity	2,000 VAC, 50/60Hz for 1min	
Dielectric strength Between contacts of the same polarity	1,000 VAC, 50/60Hz for 1min	
Vibration resistance Destruction	10 to 55 to 10 Hz, 0.5mm single amplitude (1.0mm double amplitude)	
Vibration resistance Malfunction	10 to 55 to 10 Hz, 0.5mm single amplitude (1.0mm double amplitude)	
Shock resistance Destruction	1,000 m/s ²	
Shock resistance! Malfunction	200 m/s ²	
Ambient operating temperature	-55 to 70 deg C	
Ambient operating humidity	5% to 85%	
Weight	Approx. 35 g	
*There are no change to the other specifications.		

[Characteristics] continue
 MY□-02 series and MY□F series

Operating Coil		Before the change		After the change		
Rated current	AC12	106.5mA 91 mA	(50Hz) (60Hz)			
	AC24	53.8mA 46 mA	(50Hz) (60Hz)			
	AC48/50	25.7 mA 22.0 mA	(50Hz) (AC50V) (60Hz) (AC50V)	24.7/25.7 mA	(50Hz) 21.1/22.0 mA	(60Hz)
	AC100/110	11.7/12.9mA 10/11mA	(50Hz) (60Hz)			
	AC110/120	9.9/10.8 mA 8.4/9.2 mA	(50Hz) (60Hz)			
	AC200/220	6.2/6.8 mA 5.3/5.8 mA	(50Hz) (60Hz)			
	AC220/240	4.8/5.3 mA 4.2/4.6 mA	(50Hz) (60Hz)			
	DC12	75 mA		72.7 mA		
	DC24	36.9 mA		36.3 mA		
	DC48	18.5 mA		17.6 mA		
	DC100/110	9.1/10 mA		8.7/9.6 mA		
Coil resistance	AC12	46 ohms				
	AC24	180 ohms				
	AC48/50	788 ohms				
	AC100/110	3,750 ohms				
	AC110/120	4,430 ohms				
	AC200/220	12,950 ohms				
	AC220/240	18,790 ohms				
	DC12	160 ohms		165 ohms		
	DC24	650 ohms		662 ohms		
	DC48	2,600 ohms		2,725 ohms		
	DC100/110	11,000 ohms		11,440 ohms		

Before the change	After the change
<p>【Operation ratings】 MY□-02 series and MY□F series No different</p> <p>Must operate voltage: 80% Max. Must release voltage: 30% Min. (AC type) 10% Min. (DC type) Maximum voltage: 110% of rated voltage Power consumption: Approx. 0.9 to 1.3 VA at 60Hz Approx. 0.9 W</p>	<p>【Operation ratings】 MY□-02 series and MY□F series No different</p> <p>Must operate voltage: 80% Max. Must release voltage: 30% Min. (AC type) 10% Min. (DC type) Maximum voltage: 110% of rated voltage Power consumption: Approx. 0.9 to 1.3 VA at 60Hz Approx. 0.9 W</p>

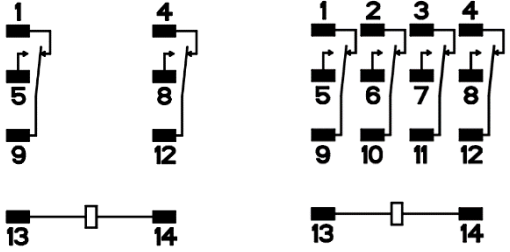
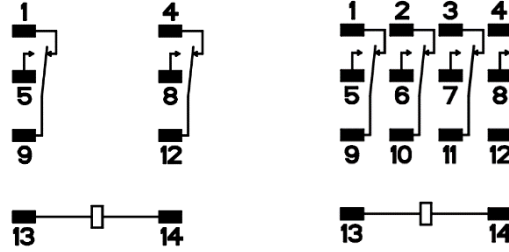
Before the change	After the change
<p>【Operation method】 MY□-02 series and MY□F series No different Coil polarity: None.</p> <p>MY2 series MY4 series</p> 	<p>【Operation method】 MY□-02 series and MY□F series No different Coil polarity: None.</p> <p>MY2 series MY4 series</p> 
<p>【Certified Standards】 MY□-02 series and MY□F series</p> <p>TUV (EN 61810-1)</p>	<p>【Certified Standards】 MY□-02 series and MY□F series</p> <p>VDE (EN 61810-1) *There are no change other certified standards.</p>

Specifications in this product news are as of the issue date and are subject to change without notice.
 Only main changes in specifications are described in this document. Please be sure to read the relevant catalogs, datasheets, product specifications, instructions, and manuals for precautions and necessary information when using products.

Before change

Old part number	Old OC product code	Old ODPOS code
MY2-02-SL-EU AC220/240	MY206080C	MY202SLEUAC220240
MY2-02-US-SV AC220/240	MY206053F	#NV
MY2-02-US-SV DC24	MY206043R	#NV
MY2-02-US-SV-EU AC220/240	MY206077C	MY202USSVEUAC220240O
MY2-02-US-SV-EU DC24	MY206074R	MY202USSVEU24DC
MY4-02-EU AC220/240	MY406266H	MY402EUAC220240
MY4-02-EU DC24	MY406262E	MY402EU24DC
MY2-02 AC100/110	MY206055B	#NV
MY2-02 AC200/220	MY206056M	#NV
MY2-02 AC200/220 /C	MY206067F	#NV
MY2-02 AC220/240	MY206051M	#NV
MY2-02 AC220/240 /C	MY206068D	#NV
MY2-02 AC24	MY206002A	#NV
MY2-02 DC12	MY206011M	#NV
MY2-02 DC24	MY206012R	#NV
MY2-02 DC48	MY206013G	#NV
MY4-02 AC110/120	MY406104A	#NV
MY4-02 AC220/240	MY406105M	#NV
MY4-02 AC24	MY406021E	#NV
MY4-02 AC50	MY406022C	#NV
MY4-02 DC12	MY406029M	#NV
MY4-02 DC24	MY406031B	#NV
MY2F-EU AC220/240	MY2 6195H	MY2FEUAC220240
MY2F AC220/240	MY2 6049H	#NV

|

After change*

New part number	New OC product code	New ODPOS code
MY2-02 AC220/240	MY201494A	#NV
MY2-02 AC220/240	MY201494A	#NV
MY2-02 DC24	MY201088A	#NV
MY2-02 AC220/240	MY201494A	#NV
MY2-02 DC24	MY201088A	#NV
MY4-02 AC220/240	MY401904E	#NV
MY4-02 DC24	MY401131A	#NV
MY2-02 AC100/110	MY201084R	#NV
MY2-02 AC200/220	MY201085G	#NV
MY2-02 AC200/220	MY201085G	#NV
MY2-02 AC220/240	MY201494A	#NV
MY2-02 AC220/240	MY201494A	#NV
MY2-02 AC24	MY201083M	#NV
MY2-02 DC12	MY201087C	#NV
MY2-02 DC24	MY201088A	#NV
MY2-02 DC48	MY201089M	#NV
MY4-02 AC110/120	MY401903G	#NV
MY4-02 AC220/240	MY401904E	#NV
MY4-02 AC24	MY401508B	#NV
MY4-02 AC48/50	MY402023M (to be released in A	#NV
MY4-02 DC12	MY401129M	#NV
MY4-02 DC24	MY401131A	#NV
MY2F AC220/240	MY2 1760F	#NV
MY2F AC220/240	MY2 1760F	#NV

|

*If After the change values are the same, it means the product only had technical or packing change, which does not effect the product codes!

Changes are highlighted with a background colour,